

DATA SHEET

MULTILAYER CERAMIC CAPACITORS

CC Series
NP0
16V TO 100V



SCOPE

This specification describes Yageo CC NP0 series chip capacitors.

ORDERING INFORMATION

Part number is identified by the series, size, tolerance, packing style, temperature coefficient, rated voltage and capacitance value.

CC xxxx x x **NP0** x **BN** xxx
 (1) (2) (3) (4) (5)

(1) SIZE

- 0402 (1005)
- 0603 (1608)
- 0805 (2012)
- 1206 (3216)
- 1210 (3225)
- 1812 (4832)

(2) TOLERANCE

- B = ±0.1pF
- C = ±0.25pF
- D = ±0.5pF
- F = ±1%
- G = ±2%
- J = ±5%

(3) PACKING STYLE

- R = 7" paper tape
- K = 7" blister tape
- P = 13" paper tape
- F = 13" blister tape
- C = Bulk case

(4) RATED VOLTAGE

- 7 = 16V
- 8 = 25V
- 9 = 50V
- 0 = 100V

(5) CAPACITANCE VALUE:

- First two for significant figures and 3rd for number of zero
- Letter "R" for decimal point

CONSTRUCTION

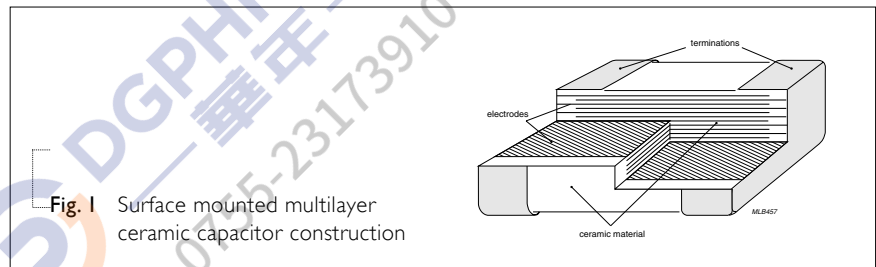

DIMENSION

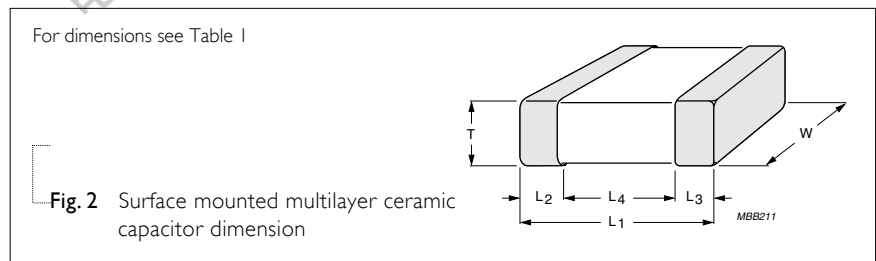

Table I

TYPE	CC0402	CC0603	CC0805	CC1206	CC1210	CC1812
L₁ (mm)	1.0±0.05	1.6±0.10	2.0±0.10	3.2±0.15	3.2±0.20	4.5±0.20
W (mm)	0.5±0.05	0.8±0.07	1.25±0.10	1.6±0.15	2.5±0.20	3.2±0.20
T (mm)	min.	0.45	0.73	0.50	0.50	0.50
	max.	0.55	0.87	1.35	1.35	1.80
L₂/L₃ (mm)	min.	0.15	0.20	0.25	0.25	0.25
	max.	0.30	0.50	0.75	0.75	0.75
L₄ (mm)	min.	0.40	0.60	0.55	1.40	2.20

CAPACITANCE RANGE & THICKNESS FOR 16V & 25V

Table 2

CAPACITANCE (pF)	16V 0402	0603	25V 0402	0603	0805	1206	1210
150							
180			0.5±0.05				
220							
270							
330	0.5±0.05						
390							
470							
560							
680							
820							
1,000				0.8±0.07			
1,200							
1,500							
1,800							
2,200		0.8±0.07					
2,700							
3,300					0.85±0.1		
3,900					1.25±0.1		
4,700							
5,600							
6,800							
8,200						0.85±0.1	
10,000							
12,000							0.6±0.1
15,000							
18,000							0.85±0.1
22,000							1.15±0.1

DGPHNST
电话: 0755-23173910

CAPACITANCE RANGE & THICKNESS FOR 50V & 100V

Table 3

CAPACITANCE (pF)	50V 0402	0603	0805	1206	1210	1812	100V 0603	0805	1206	1210	1812
0.47											
0.56											
0.68											
0.82											
1.0											
1.2											
1.5											
1.8											
2.2											
2.7											
3.3											
3.9											
4.7											
5.6											
6.8											
8.2											
10	0.5±0.05	0.8±0.07	0.6±0.1	0.6±0.1							
12											
15											
18											
22											
27											
33											
39											
47							0.8±0.07	0.6±0.1	0.6±0.1		
56											
82											
100											
120											
150											
180											
220											



CAPACITANCE RANGE & THICKNESS FOR 50V & 100V (CONT.)

Table 4

CAPACITANCE (pF)	50V				100V						
	0402	0603	0805	1206	1210	1812	0603	0805	1206	1210	1812
270											
330											
390		0.8±0.07					0.8±0.07				
470			0.6±0.1					0.6±0.1			
560											
680											
820				0.6±0.1					0.6±0.1		
1,000											
1,200											
1,500			0.85±0.1					0.85±0.1			
1,800											
2,200			1.25±0.1		0.6±0.1			1.25±0.1			
2,700											
3,300											
3,900				0.85±0.1					0.85±0.1		
4,700						0.6±0.1					
5,600				1.15±0.1					1.15±0.1		
6,800					0.85±0.1						
8,200										0.85±0.1	
10,000											
12,000						0.85±0.1					0.85±0.1
15,000											
18,000											
22,000						1.15±0.1					1.15±0.1

THICKNESS CLASSES AND PACKING QUANTITY

Table 5

THICKNESS CLASSIFICATION (mm)	8mm TAPE WIDTH / AMOUNT PER REEL				12mm TAPE WIDTH / AMOUNT PER REEL		AMOUNT PER BULK CASE			
	Ø180mm, 7"		Ø330mm, 13"		Ø180mm, 7" Blister		1812	0402	0603	0805
	Paper	Blister	Paper	Blister						
0.5±0.05	10,000	---	50,000	---	---	---	50,000	---	---	---
0.6±0.1	4,000	---	20,000	---	---	---	---	---	---	10,000
0.8±0.07	4,000	---	15,000	---	---	---	---	15,000	---	---
0.85±0.1	4,000	---	15,000	---	---	---	---	---	---	8,000
1.15±0.1	---	3,000	---	10,000	---	---	---	---	---	---
1.25±0.1	---	3,000	---	10,000	---	---	---	---	---	5,000

ELECTRICAL CHARACTERISTICS

Table 6

CHARACTERISTICS	TEST CONDITIONS	REQUIREMENT
Operation temperature range	---	-55°C to +125°C
Temperature characteristic/coefficient (TC)	With respect to 20°C within operation temperature range	NP0=16V, 0±60ppm/K NP0>16V, 0±30ppm/K
Capacitance tolerance	With respect to 20°C C≤1000pF 1Vrms/1MHz C>1000pF 1Vrms/1KHz	C<5; ±0.1pF, ±0.25pF C≥5; ±0.25pF, ±0.5pF C≥10pF; ±2%, ±5%
Dissipation factor (D.F.)	With respect to 20°C C≤1,000pF 1Vrms/1MHz C>1,000pF 1Vrms/1KHz	C<10pF D.F. ≤10(3/C+0.7) ×10 ⁻⁴ or 30×10 ⁻⁴ whichever is less C≥10pF, D.F. ≤10×10 ⁻⁴
Insulation resistance (IR)	At U _r (rated voltage) for 1 minute U _r >500V, at 500V(DC) for 1 minute	R _{ins} >10GΩ or R _{ins} × C ≥500s whichever is less
Dielectric withstanding Voltage	At 2.5× U _r (for U _r ≤100V) 1.5× U _r +100V (for U _r >100V) for 5sec	No breakdown

TAPING REEL

Table 7

TAPE WIDE	8mm	8mm	12mm
ØA (mm)	180	330	180
ØB (mm)	62±1.5	62±1.5	62±1.5
ØD (mm)	20.5	20.5	20.5
ØC (mm)	12.75±0.15/-0	12.75±0.15/-0	12.75±0.15/-0
W (mm)	8.4+1.5/-0	8.4+1.5/-0	12.4+2/-0
T _{max} (mm)	14.4	14.4	18.4

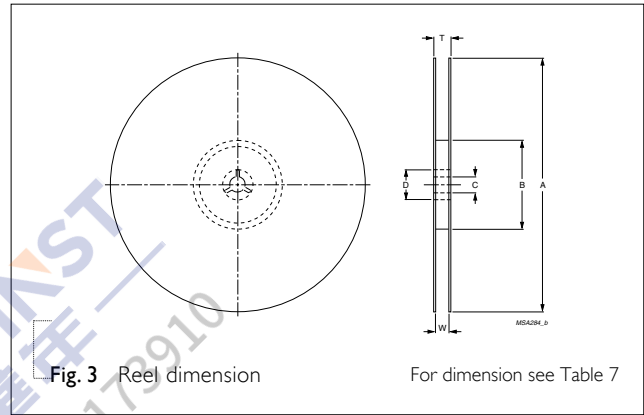

PAPER TAPE SPECIFICATION

Table 8

DIMENSION	0402	0603	0805	1206
A (mm)	0.62±0.05	1.10±0.05	1.65±0.05	2.0±0.1
B (mm)	1.12±0.05	1.90±0.05	2.4±0.05	3.5±0.1
W (mm)	8.0±0.2	8.0±0.2	8.0±0.2	8.0±0.2
E (mm)	1.75±0.1	1.75±0.1	1.75±0.1	1.75±0.1
F (mm)	3.5±0.05	3.5±0.05	3.5±0.05	3.5±0.05
P ₀ (mm)	4±0.05	4±0.05	4±0.05	4±0.05
P ₁ (mm)	2±0.05	4±0.1	4±0.1	4±0.1
P ₂ (mm)	2±0.05	2±0.05	2±0.05	2±0.05
ØD ₀ (mm)	1.5+0.1	1.5+0.1	1.5+0.1/-0	1.5+0.1/-0
T (mm)	0.6±0.05	0.95±0.05	0.95±0.05	0.95±0.05

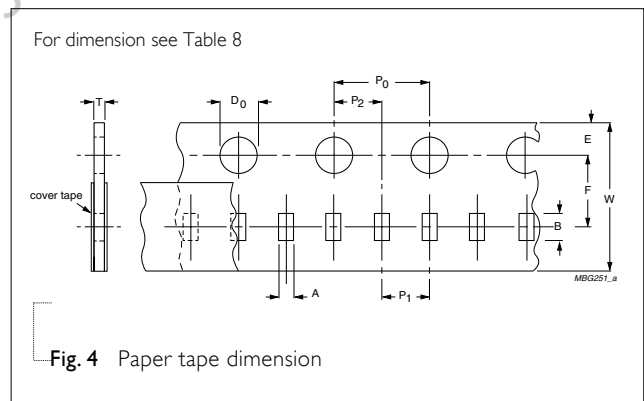

BLISTER TAPE SPECIFICATION

Table 9

DIMENSION	0805	1206	1210	1812
A (mm)	0.20	0.30	0.30	0.40
B (mm)	0.20	0.30	0.30	0.40
W (mm)	8.1±0.2	8.1±0.2	8.1±0.2	12.0±0.2
E (mm)	1.75±0.1	1.75±0.1	1.75±0.1	1.75±0.1
F (mm)	3.5±0.05	3.5±0.05	3.5±0.05	5.5±0.05
P ₀ (mm)	4±0.1	4±0.1	4±0.1	4±0.1
P ₁ (mm)	4±0.1	4±0.1	4±0.1	8±0.1
P ₂ (mm)	2±0.05	2±0.05	2±0.05	2±0.05
ØD ₀ (mm)	1.5+0.1/-0	1.5+0.1/-0	1.5+0.1/-0	1.5+0.1/-0
T _{max} (mm)	3.5	3.5	3.5	3.5

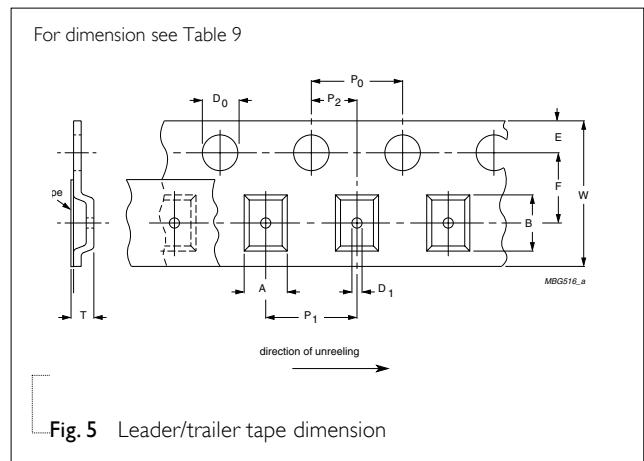

PACKING METHOD

LEADER/TRAILER TAPE SPECIFICATION

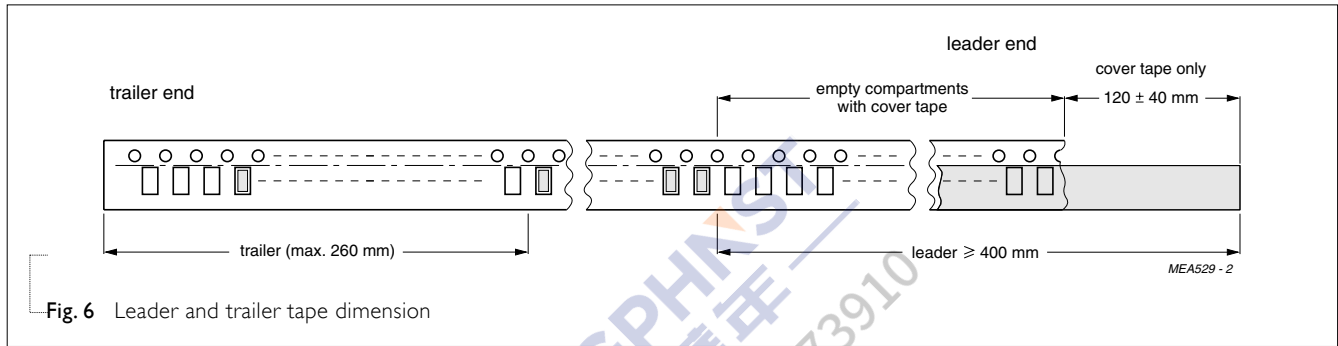

METHOD OF MOUNTING

For normal use the capacitors may be mounted on printed-circuit boards or ceramic substrates by applying wave soldering, reflow soldering (including vapor phase soldering) or conductive adhesive in accordance with CECC 00802 classification A.

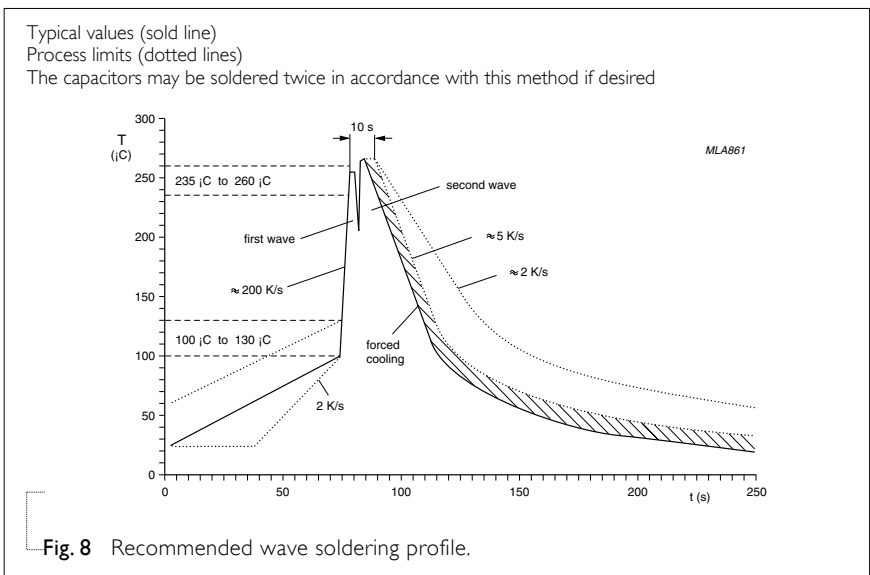
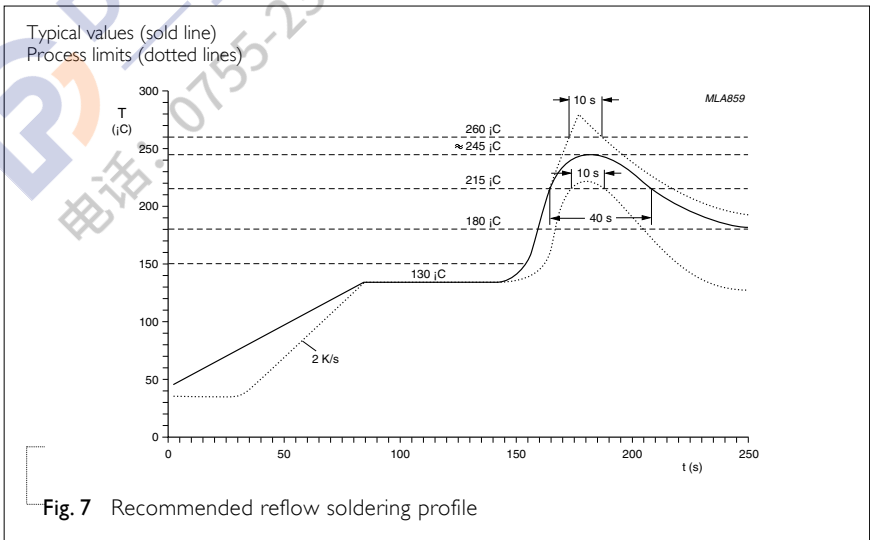

TEST AND REQUIREMENT

Table 10

IEC384-10	TEST ITEMS	CONDITIONS	REQUIREMENTS
4.9	Bending	Bending rate 1mm/s, jig. radius 340mm	$I\Delta C/CI \leq 1\%$
4.10	Resistance to soldering heat	$260 \pm 5^\circ\text{C}$ for $10 \pm 0.5\text{s}$ in static solder bath	$I\Delta C/CI$ within 0.5% or 0.5pF whichever is greater
4.11	Solderability	$235 \pm 5^\circ\text{C}$ for $2 \pm 0.5\text{s}$ in a static solder bath	The termination shall be well tinned
4.12	Rapid change of temperature	-55°C to $+125^\circ\text{C}$, 5 cycles	$I\Delta C/CI$ within 1% or 1pF, whichever is greater
4.14	Damp heat	At 40°C , 90 to 95% RH and U_r applied for 500 hours	$I\Delta C/CI$ within 2% or 1pF whichever is greater D.F. $\leq 2 \times$ specified value $IR \geq 2,500\text{M}\Omega$ or $RxC \geq 25\text{s}$, whichever is less
4.15	Endurance	At upper category temperature $2 \times U_r$ applied ($1.5 \times U_r$ for $U_r > 50\text{V}$) for 1,000 hours	$I\Delta C/CI$ within 2% or 1pF whichever is greater D.F. $\leq 2 \times$ specified value $IR \geq 4,000\text{M}\Omega$ or $RxC \geq 40\text{s}$, whichever is less

REVISION HISTORY

REVISION	DATE	CHANGE NOTIFICATION	DESCRIPTION
Version 06	Jul 07, 2005	-	- Thickness updated
Version 05	Mar 12, 2004	-	- Thickness and packing quantity amending
Version 04	Aug. 13, 2003	-	- Taping drawing amended
Version 03	Dec. 03, 2002	-	- New Yageo edition
Version 02	Jul. 04, 2002	-	-
Version 01			
Version 0			- First issue of this specification

