



丽智电子
LIZ Electronics

2022 / 2023

PRODUCT CATALOGUE

DEPHANST
电话: 0755-23179910





昆山



南通

丽智电子于1988年在台湾土城成立，2000年于昆山设立丽智电子（昆山）有限公司，占地面积2万平方米，2016年成立丽智电子（南通）有限公司，占地10万平方米。

作为台湾金宝&仁宝集团的一员，公司秉持“领先、创新、完美”的理念，从事贴片电阻及芯片二极管的研发、生产、销售，并提供专业的服务。凭借先进的管理体系、优质的产品质量和完善的售后服务，丽智电子已经成为众多国内外知名企业的电子元器件供应商。

丽智电子元件用于工业计算机、汽车、消费电子、通信及医疗市场的各种类型的电子设备中。

百尺竿头更进一步，丽智致力于成为您最佳的元器件合作伙伴！

LIZ Electronics was established in Taiwan in 1988, and setup LIZ KunShan Factory in 2000, landed 20000m². In 2016, LIZ Nantong Factory is built, landed 100000 m².

As a member of Kinpo & Compal Group, LIZ focus on research & development, production, sales and professional service of chip resistors and chip diodes with the concept of "Lead, Intelligence and Zero". LIZ is one of key electronic component suppliers for famous global companies.

LIZ products are applied in equipments of industrial computers, automobile, consumer electronics, telecomm and medical fields.

Good better best, never let it rest. Till good is better, but better best. LIZ will become your best partner for electronic components.



领先 / 创新 / 完美

LEAD INNOVATION ZERO

Good better best, never let it rest. Till good is better, but better best. LIZ will become your best partner for electronic components.

贴片电阻&贴片排阻		Chip Resistors & Chip Arrays	页码 Page
CR系列	厚膜贴片电阻	Thick Film Chip Resistors	04/06
	电阻本体字码标示	Mark On The Resistors Body	07
	标准电阻值	Standard Nominal Resistance Value	08/10
CR系列	低阻值厚膜贴片电阻	Low Resistance Thick Film Chip Resistors	11/14
CR系列	LED厚膜贴片电阻	LED Thick Film Chip Resistors	15/16
CA系列	厚膜贴片排阻-凸式电极	Thick Film Chip Array Resistors	17/19
CH系列	高功率厚膜贴片电阻	High Power Thick Film Chip Resistors	20/22
AQ系列	汽车厚膜贴片电阻	Automotive Thick Film Chip Resistors	23/25
AS系列	抗硫化厚膜贴片电阻	Anti-Sulfuration Thick Film Chip Resistors	26/28
RM系列	合金贴片电阻	Metal Current Sensing Chip Resistors	29/31
AM系列	车用合金贴片电阻	Metal Current Sensing Chip Resistors for Automotive	32/34
RZ系列	低阻分流器贴片电阻	Low-Resistance Shunt Chip Resistors	35/38
RM系列	高功率合金贴片电阻	High Power Metal Current Sensing Chip Resistors for RM 3W	39/41
PF系列	无铅厚膜贴片电阻	Total Lead Free Thick Film Chip Resistors	42/44
RC系列	高压厚膜贴片电阻	High Voltage Thick Film Chip Resistors	45/47
RS系列	抗浪涌厚膜贴片电阻	Anti-Surge Thick Film Chip Resistors	48/51
RW系列	宽电极厚膜贴片电阻	Wide Terminal Thick Film Chip Resistors	52/54
AW系列	抗硫车用宽电极厚膜贴片电阻	Anti-Sulfuration Wide Terminal Thick Film Chip Resistors	55/57
	产品信赖性测试	Product Reliability Test Methods	58/61
	贴片电阻包装规格	Chip Resistors Tapping Specification	62/64

贴片二极管		Chip Diodes	页码 Page
CD系列	芯片开关二极管	Chip Switching Diodes	65/72
CDZ系列	芯片稳压二极管	Chip Zener Diodes	73/81
CDB系列	芯片肖特基二极管	Chip Schottky Diodes	82/89
	可靠性测试	Reliability Test	90

特性 Features

适合贴片机组装 Suitable for SMT
 短小轻薄 Small Size & Light Weight
 符合RoHS和无卤标准 Meet RoHS & HF Requirement

应用 Application

一般用途 General Purpose
 通用型 Universal type

构造 Construction

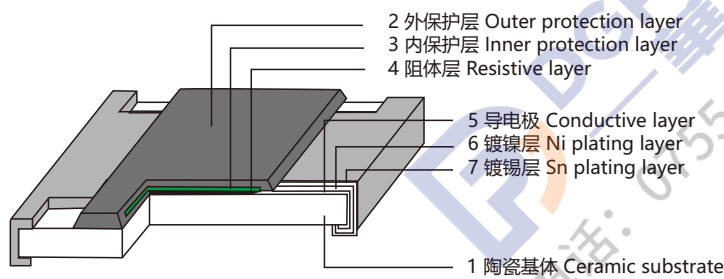

功率衰减曲线 Power Derating Curve

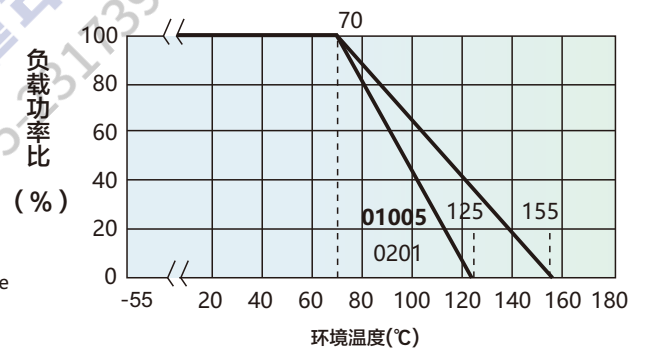

订货方式 (例如0603 5% 1/10W 100Ω)

Ordering Procedure (Example 0603 1/10W 5% 100Ω)

料号 (Part Number) : CR0603JA0101G

CR	0603	J	A	0101	G
类型 (Type) CR: 厚膜贴片电阻 (Thick Film Chip Resistors)	尺寸 (Size) 1005 0201 0402 0603 0805 1206 1210 1812 2010 2512	公差 Tolerance B=±0.1% D=±0.5% F=±1% G=±2% J=±5% K=±10%	额定功率 Rated Power 1=1W 2=3/4W 3=1/2W 4=1/4W 8=1/8W A=1/10W F=1/16W H=1/20W L=1/32W	阻值 Resistance Value ±1%, ±0.5% ±0.1% 49R9=49.9Ω 1002=10KΩ ±2%, ±5%: 06R8=6.8Ω 0564=560KΩ	包装代码 Packing Code G= Reel (卷装) S=10 inch reel 卷装 U=13 inch reel 卷装 V= bulk (散料)

标准包装数量 Standard Packing Quantity

01005 20,000Pcs Per Reel(每卷20, 000Pcs)
 0201/0402 : 10,000Pcs Per Reel(每卷10, 000Pcs)
 0603/0805/1206/1210: 5,000Pcs Per Reel(每卷5, 000Pcs)
 1812/2010/2512: 4,000Pcs Per Reel(每卷4, 000Pcs)

备注: 1005为01005规格
 Remark: 1005 is 01005 size

规格 Specifications

类型 Type	CR1005	CR0201	CR0402	CR0603	CR0805	CR1206	CR1210	CR1812	CR2010	CR2512
额定功率 70°C Rated Power at 70°C	1/32W	1/20W	1/16W	1/10W	1/8W	1/4W	1/2W	1/2W	3/4W	1W
最大工作电压 Max Working Voltage	15V	25V	50V	75V	150V	200V	200V	200V	200V	200V
最大过负荷电压 Max Overload Voltage	30V	50V	100V	150V	300V	400V	500V	500V	500V	500V
绝缘耐压 Dielectric Withstanding Voltage	30V	75V	150V	220V	430V	570V	710V	710V	710V	710V
操作温度范围 Operating Temperature	-55 ~ +125°C	-55 ~ +125°C	-55 ~ +155°C	-55 ~ +155°C	-55 ~ +155°C	-55 ~ +155°C	-55 ~ +155°C	-55 ~ +155°C	-55 ~ +155°C	-55 ~ +155°C
零欧姆电阻阻值 Resistance Value of Jumper	< 50mΩ	< 50mΩ	< 50mΩ	< 50mΩ	< 50mΩ	< 50mΩ	< 50mΩ	< 50mΩ	< 50mΩ	< 50mΩ
零欧姆额定电流 Rated Current of Jumper	0.5A	0.5A	1.0A	1.0A	2.0A	2.0A	2.0A	2.0A	2.0A	2.0A
零欧姆电阻最大电流 Max Current of Jumper	1.0A	1.0A	2.0A	2.0A	5.0A	10.0A	10.0A	10.0A	10.0A	10.0A
0.5%阻值范围 Resistance Range of 0.5%	-	-	10Ω-1MΩ	10Ω-1MΩ	10Ω-1MΩ	10Ω-1MΩ	10Ω-1MΩ	10Ω-1MΩ	10Ω-1MΩ	10Ω-1MΩ
1%阻值范围 Resistance Range of 1%	1Ω-10MΩ	1Ω-10MΩ	1Ω~22MΩ	1Ω~22MΩ	1Ω~22MΩ	1Ω~22MΩ	1Ω~22MΩ	1Ω-10MΩ	1Ω~22MΩ	1Ω~22MΩ
2%阻值范围 Resistance Range of 2%	1Ω-10MΩ	1Ω-10MΩ	1Ω~22MΩ	1Ω~22MΩ	1Ω~22MΩ	1Ω~22MΩ	1Ω~22MΩ	1Ω-10MΩ	1Ω~22MΩ	1Ω~22MΩ
5%阻值范围 Resistance Range of 5%	1Ω-10MΩ	1Ω-10MΩ	1Ω~22MΩ	1Ω~100MΩ	1Ω~100MΩ	1Ω~100MΩ	1Ω~100MΩ	1Ω-10MΩ	1Ω~100MΩ	1Ω~100MΩ

外形尺寸 Dimension

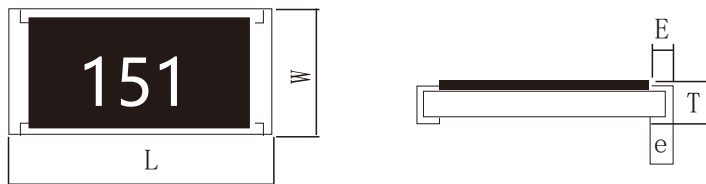

类型 Type	CR1005	CR0201	CR0402	CR0603	CR0805	CR1206	CR1210	CR1812	CR2010	CR2512	
尺寸 Dimension	L(mm)	0.40±0.02	0.60±0.03	1.00±0.05	1.60±0.10	2.00±0.15	3.10±0.15	3.10±0.15	4.50±0.20	5.00±0.20	6.25±0.20
	W(mm)	0.20±0.02	0.30±0.03	0.50±0.05	0.80±0.10	1.25±0.15	1.60±0.15	2.50±0.15	3.10±0.20	2.50±0.20	3.10±0.20
	T(mm)	0.13±0.02	0.23±0.03	0.30±0.05	0.45±0.10	0.50±0.10	0.55±0.10	0.55±0.15	0.55±0.15	0.55±0.15	0.55±0.15
	E(mm)	0.10±0.03	0.10±0.05	0.15±0.10	0.25±0.20	0.35±0.20	0.45±0.25	0.35±0.25	0.55±0.20	0.65±0.25	0.85±0.25
	e(mm)	0.11±0.03	0.15±0.05	0.20±0.10	0.30±0.20	0.40±0.20	0.40±0.25	0.60±0.25	0.70±0.20	0.50±0.25	0.95±0.25

性能 Performance Specifications

内容 Item	测试方法 Test Methods	规格 Specification Limits
温度系数 Temperature Coefficient	JIS C5201 4.8	01005规格: 1Ω≤R≤10Ω: -200~+600 PPM/°C 10Ω<R≤10MΩ: ±250 PPM/°C 0201规格: 1Ω≤R≤10Ω: -100~+300 PPM/°C 10Ω<R≤10MΩ: ±200 PPM/°C 0402~2512规格: 1Ω≤R≤10Ω: ±200PPM/°C 10Ω<R≤10MΩ: ±100 PPM/°C 10MΩ<R≤100MΩ: ±200 PPM/°C
焊锡性 Solderability	JIS C5201 4.17	最少95%面积上锡 Min 95% coverage
绝缘电阻 Insulation Resistance	JIS C5201 4.6	> 10GΩ
绝缘耐压 Dielectric Withstanding Voltage	JIS C5201 4.7	无击穿、飞弧及可见机械性损伤 No evidence of flashover, mechanical damage arcing or insulation breakdown
短时间过负荷 Short-Time Overload	JIS C5201 4.13	±(1.0%+0.05Ω)Max(最大)
端子弯曲 Terminal Bending	JIS C5201 4.33	±(1.0%+0.05Ω)Max(最大)
抗焊锡热 Resist to Soldering Heat	JIS C5201 4.18	±(1.0%+0.05Ω)Max(最大)
负荷寿命 Load Life	JIS C5201 4.25.1	01005规格: ±(5.0%+0.05Ω)Max(最大) 0201~2512规格: ±(2.0%+0.05Ω)Max(最大)
耐湿特性 Humidity	JIS C5201 4.24	±(2.0%+0.05Ω)Max(最大)
温度循环 Temperature Cycling	JIS C5201 4.19	±(2.0%+0.05Ω)Max(最大)
温湿循环 Moisture Resistance	MIL-STD-202 METHOD106	±(2.0%+0.05Ω)Max(最大)

<ul style="list-style-type: none"> ❖ 01005、0201及0402因本体太小，本体上无字码标示 For 01005、0201 and 0402 size, no marking on the body due to the small size of the resistor ❖ 公差±5%的产品，以三字码标示，前两位表示阻值的有效数字，最后一位表示的10的乘幂 ±5%, Tolerance product: the marking is 3 digits, the first 2 digits are significant figures of resistance value and the 3rd one denotes the power number of 10, (10^x) ❖ ±0.5%, ±1%的产品，以四字码标示，前三位表示阻值的有效数字，最后一位表示10的乘幂 ±0.5%, ±1% tolerance product: the marking is 4 digits, the first 3 digits are significant figures of resistance value and the 4th one denotes the power number of 10, (10^x) ❖ 0603±1% E96系列的标准阻值，因电阻本体太小，采用三位代码标示。 Standard E96 series values of 0603±1%: due to the small size of the resistor's body, use 3 digits code to indicate the resistance value. 	<div style="border: 1px solid black; padding: 5px; margin-bottom: 5px; background-color: #333; color: white; font-weight: bold; font-size: 1.2em;">472</div> <div style="border: 1px solid black; padding: 5px; margin-bottom: 5px; background-color: #333; color: white; font-weight: bold; font-size: 1.2em;">5R6</div> <div style="border: 1px solid black; padding: 5px; margin-bottom: 5px; background-color: #333; color: white; font-weight: bold; font-size: 1.2em;">4992</div> <div style="border: 1px solid black; padding: 5px; background-color: #333; color: white; font-weight: bold; font-size: 1.2em;">6R81</div>	<p>472=47×10²=4.7KΩ</p> <hr/> <p>10Ω以下标示: 5R6=5.6Ω Below 10Ω: 5R6=5.6Ω</p> <hr/> <p>4992=499×10²=49.9KΩ</p> <hr/> <p>100Ω以下标示: 6R81=6.81Ω Below 100Ω: 6R81=6.81Ω</p>
---	---	--

E24系列的标准阻值代码 Standard E24 series Resistance Code

1.0、1.1、1.2、1.3、1.5、1.6、1.8、2.0、2.2、2.4、2.7、3.0、3.3、3.6、3.9、4.3、4.7、5.1、5.6、6.2、6.8、7.5、8.2、9.1

0603±1% E96系列的标准阻值代码 Standard E96 Series Resistance Value Code For 0603±1% Marking

代码 Code	阻值 Value	代码 Code	阻值 Value	代码 Code	阻值 Value	代码 Code	阻值 Value	代码 Code	阻值 Value	代码 Code	阻值 Value
01	100	17	147	33	215	49	316	65	464	81	681
02	102	18	150	34	221	50	324	66	475	82	698
03	105	19	154	35	226	51	332	67	487	83	715
04	107	20	158	36	232	52	340	68	499	84	732
05	110	21	162	37	237	53	348	69	511	85	750
06	113	22	165	38	243	54	357	70	523	86	768
07	115	23	169	39	249	55	365	71	536	87	787
08	118	24	174	40	255	56	374	72	549	88	806
09	121	25	178	41	261	57	383	73	562	89	825
10	124	26	182	42	267	58	392	74	576	90	845
11	127	27	187	43	274	59	402	75	590	91	866
12	130	28	191	44	280	60	412	76	604	92	887
13	133	29	196	45	287	61	422	77	619	93	909
14	137	30	200	46	294	62	432	78	634	94	931
15	140	31	205	47	301	63	442	79	649	95	953
16	143	32	210	48	309	64	453	80	665	96	976

0603±1% E96系列的指数代码 Multiplier Code For 0603±1% Marking

代码 Code	Y	X	A	B	C	D	E	F	G
指数 Multiplier	10 ⁻²	10 ⁻¹	10 ⁰	10 ¹	10 ²	10 ³	10 ⁴	10 ⁵	10 ⁶

阻值标示如下 So the resistance value are marked as the following examples



10D=124×10⁻³=124KΩ



38Y=243×10⁻²=2.43Ω

0603±1%的产品，在标准E24系列中，但不属于E96系列，标示与5%的字码相同，但是在字码下加一条线

Standard E24 and not belong to E96 series values of 0603±1%, the marking is the same as 5% tolerance but marking as underline



331=33×10¹=330Ω



560=56×10⁰=56Ω

下表列出每种系列的标准阻值，表中的阻值是按照通用倍率得出的接近阻值。

The below chart shows the nominal resistance value for each series. The values in the chart have been in this order using the approximate values that are based on the common ratios given in the following table.

Series 系列	Common Ratio 通用倍率	Remarks 备注
E-6	$\sqrt[6]{10}(1.46)$	Rounded off to a 2-digit figure(2位有效数字)
E-12	$\sqrt[12]{10}(1.21)$	Rounded off to a 2-digit figure(2位有效数字)
E-24	$\sqrt[24]{10}(1.10)$	Rounded off to a 2-digit figure(2位有效数字)
E-96	$\sqrt[96]{10}(1.02)$	Rounded off to a 3-digit figure(3位有效数字)

E-6	E-12	E-24	E-96	E-6	E-12	E-24	E-96	E-6	E-12	E-24	E-96		
1.0	1.0	1.0	1.00	2.2	2.2	2.2	2.15	4.7	4.7	4.7	4.64		
			1.02				2.21				4.75		
			1.05			2.26	4.87						
			1.07			2.32	4.99						
		1.10	2.4			2.4	2.37			5.1	5.11		
		1.13					2.43				5.23		
	1.15	1.2	1.2	2.49	5.6	5.36							
	1.18			2.55		5.49							
	1.21			2.7		2.7	2.61		5.6	5.62			
	1.24						2.67			5.76			
	1.27						2.74			5.90			
	1.30						2.80			6.04			
	1.33	1.3	1.3	2.87	6.2	6.19							
	1.37			2.94		6.34							
	1.40			3.01		6.49							
	1.43			3.09		6.65							
	1.5	1.5	1.5	1.47	3.3	3.3	3.3		3.16	6.8	6.8	6.8	6.81
				1.50					3.24				6.98
1.54				3.32			7.15						
1.58				3.40			7.32						
1.62			3.6	3.6			3.48	7.5	7.50				
1.65							3.57		7.68				
1.69		1.8	1.8	3.65	8.2	8.2	7.87						
1.74				3.74			8.06						
1.78				3.9			3.9	3.83	8.2		8.25		
1.82								3.92			8.45		
1.87								4.02			8.66		
1.91								4.12			8.87		
1.96		2.0	2.0	4.22	9.1	9.1	9.09						
2.00				4.32			9.31						
2.05				4.42			9.53						
2.10				4.53			9.76						

标E-24 series standard resistance value & the codes to be used in the part NO.system 5% &10% tolerance (4 digits,start with "O"):
 E-24 系列标准阻值和料号系统使用代码 (4位, 以0为首位, 5%、10%公差) :

阻值 Value	代码 Code	阻值 Value	代码 Code	阻值 Value	代码 Code	阻值 Value	代码 Code	阻值 Value	代码 Code	阻值 Value	代码 Code	阻值 Value	代码 Code
1.0Ω	01R0	10Ω	0100	100Ω	0101	1.0KΩ	0102	10KΩ	0103	100KΩ	0104	1.0MΩ	0105
1.1Ω	01R1	11Ω	0110	110Ω	0111	1.1KΩ	0112	11KΩ	0113	110KΩ	0114	1.1MΩ	0115
1.2Ω	01R2	12Ω	0120	120Ω	0121	1.2KΩ	0122	12KΩ	0123	120KΩ	0124	1.2MΩ	0125
1.3Ω	01R3	13Ω	0130	130Ω	0131	1.3KΩ	0132	13KΩ	0133	130KΩ	0134	1.3MΩ	0135
1.5Ω	01R5	15Ω	0150	150Ω	0151	1.5KΩ	0152	15KΩ	0153	150KΩ	0154	1.5MΩ	0155
1.6Ω	01R6	16Ω	0160	160Ω	0161	1.6KΩ	0162	16KΩ	0163	160KΩ	0164	1.6MΩ	0165
1.8Ω	01R8	18Ω	0180	180Ω	0181	1.8KΩ	0182	18KΩ	0183	180KΩ	0184	1.8MΩ	0185
2.0Ω	02R0	20Ω	0200	200Ω	0201	2.0KΩ	0202	20KΩ	0203	200KΩ	0204	2.0MΩ	0205
2.2Ω	02R2	22Ω	0220	220Ω	0221	2.2KΩ	0222	22KΩ	0223	220KΩ	0224	2.2MΩ	0225
2.4Ω	02R4	24Ω	0240	240Ω	0241	2.4KΩ	0242	24KΩ	0243	240KΩ	0244	2.4MΩ	0245
2.7Ω	02R7	27Ω	0270	270Ω	0271	2.7KΩ	0272	27KΩ	0273	270KΩ	0274	2.7MΩ	0275
3.0Ω	03R0	30Ω	0300	300Ω	0301	3.0KΩ	0302	30KΩ	0303	300KΩ	0304	3.0MΩ	0305
3.3Ω	03R3	33Ω	0330	330Ω	0331	3.3KΩ	0332	33KΩ	0333	330KΩ	0334	3.3MΩ	0335
3.6Ω	03R6	36Ω	0360	360Ω	0361	3.6KΩ	0362	36KΩ	0363	360KΩ	0364	3.6MΩ	0365
3.9Ω	03R9	39Ω	0390	390Ω	0391	3.9KΩ	0392	39KΩ	0393	390KΩ	0394	3.9MΩ	0395
4.3Ω	04R3	43Ω	0430	430Ω	0431	4.3KΩ	0432	43KΩ	0433	430KΩ	0434	4.3MΩ	0435
4.7Ω	04R7	47Ω	0470	470Ω	0471	4.7KΩ	0472	47KΩ	0473	470KΩ	0474	4.7MΩ	0475
5.1Ω	05R1	51Ω	0510	510Ω	0511	5.1KΩ	0512	51KΩ	0513	510KΩ	0514	5.1MΩ	0515
5.6Ω	05R6	56Ω	0560	560Ω	0561	5.6KΩ	0562	56KΩ	0563	560KΩ	0564	5.6MΩ	0565
6.2Ω	06R2	62Ω	0620	620Ω	0621	6.2KΩ	0622	62KΩ	0623	620KΩ	0624	6.2MΩ	0625
6.8Ω	06R8	68Ω	0680	680Ω	0681	6.8KΩ	0682	68KΩ	0683	680KΩ	0684	6.8MΩ	0685
7.5Ω	07R5	75Ω	0750	750Ω	0751	7.5KΩ	0752	75KΩ	0753	750KΩ	0754	7.5MΩ	0755
8.2Ω	08R2	82Ω	0820	820Ω	0821	8.2KΩ	0822	82KΩ	0823	820KΩ	0824	8.2MΩ	0825
9.1Ω	09R1	91Ω	0910	910Ω	0911	9.1KΩ	0912	91KΩ	0913	910KΩ	0914	9.1MΩ	0915
												10MΩ	0106

E-96 series standard resistance value & the codes to be used in the part NO.system not over 2% tolerance (4 digits):
 E-96 系列标准阻值和料号系统使用代码 (4位, 0.1%,0.25%,0.5%,1%,2%公差) :

阻值 Value	代码 Code	阻值 Value	代码 Code	阻值 Value	代码 Code	阻值 Value	代码 Code	阻值 Value	代码 Code	阻值 Value	代码 Code	阻值 Value	代码 Code	阻值 Value	代码 Code
10.0Ω	10R0	17.8Ω	17R8	31.6Ω	31R6	56.2Ω	56R2	100Ω	1000	178Ω	1780	316Ω	3160	562Ω	5620
10.2Ω	10R2	18.2Ω	18R2	32.4Ω	32R4	57.6Ω	57R6	102Ω	1020	182Ω	1820	324Ω	3240	576Ω	5760
10.5Ω	10R5	18.7Ω	18R7	33.2Ω	33R2	59.0Ω	59R0	105Ω	1050	187Ω	1870	332Ω	3320	590Ω	5900
10.7Ω	10R7	19.1Ω	19R1	34.0Ω	34R0	60.4Ω	60R4	107Ω	1070	191Ω	1910	340Ω	3400	604Ω	6040
11.0Ω	11R0	19.6Ω	19R6	34.8Ω	34R8	61.9Ω	61R9	110Ω	1100	196Ω	1960	348Ω	3480	619Ω	6190
11.3Ω	11R3	20.0Ω	20R0	35.7Ω	35R7	63.4Ω	63R4	113Ω	1130	200Ω	2000	357Ω	3570	634Ω	6340
11.5Ω	11R5	20.5Ω	20R5	36.5Ω	36R5	64.9Ω	64R9	115Ω	1150	205Ω	2050	365Ω	3650	649Ω	6490
11.8Ω	11R8	21.0Ω	21R0	37.4Ω	37R4	66.5Ω	66R5	118Ω	1180	210Ω	2100	374Ω	3740	665Ω	6650
12.1Ω	12R1	21.5Ω	21R5	38.3Ω	38R3	68.1Ω	68R1	121Ω	1210	215Ω	2150	383Ω	3830	681Ω	6810
12.4Ω	12R4	22.1Ω	22R1	39.2Ω	39R2	69.8Ω	69R8	124Ω	1240	221Ω	2210	392Ω	3920	698Ω	6980
12.7Ω	12R7	22.6Ω	22R6	40.2Ω	40R2	71.5Ω	71R5	127Ω	1270	226Ω	2260	402Ω	4020	715Ω	7150
13.0Ω	13R0	23.2Ω	23R2	41.2Ω	41R2	73.2Ω	73R2	130Ω	1300	232Ω	2320	412Ω	4120	732Ω	7320
13.3Ω	13R3	23.7Ω	23R7	42.2Ω	42R2	75.0Ω	75R0	133Ω	1330	237Ω	2370	422Ω	4220	750Ω	7500
13.7Ω	13R7	24.3Ω	24R3	43.2Ω	43R2	76.8Ω	76R8	137Ω	1370	243Ω	2430	432Ω	4320	768Ω	7680
14.0Ω	14R0	24.9Ω	24R9	44.2Ω	44R2	78.7Ω	78R7	140Ω	1400	249Ω	2490	442Ω	4420	787Ω	7870
14.3Ω	14R3	25.5Ω	25R5	45.3Ω	45R3	80.6Ω	80R6	143Ω	1430	255Ω	2550	453Ω	4530	806Ω	8060
14.7Ω	14R7	26.1Ω	26R1	46.4Ω	46R4	82.5Ω	82R5	147Ω	1470	261Ω	2610	464Ω	4640	825Ω	8250
15.0Ω	15R0	26.7Ω	26R7	47.5Ω	47R5	84.5Ω	84R5	150Ω	1500	267Ω	2670	475Ω	4750	845Ω	8450
15.4Ω	15R4	27.4Ω	27R4	48.7Ω	48R7	86.6Ω	86R6	154Ω	1540	274Ω	2740	487Ω	4870	866Ω	8660
15.8Ω	15R8	28.0Ω	28R0	49.9Ω	49R9	88.7Ω	88R7	158Ω	1580	280Ω	2800	499Ω	4990	887Ω	8870
16.2Ω	16R2	28.7Ω	28R7	51.1Ω	51R1	90.9Ω	90R9	162Ω	1620	287Ω	2870	511Ω	5110	909Ω	9090
16.5Ω	16R5	29.4Ω	29R4	52.3Ω	52R3	93.1Ω	93R1	165Ω	1650	294Ω	2940	523Ω	5230	931Ω	9310
16.9Ω	16R9	30.1Ω	30R1	53.6Ω	53R6	95.3Ω	95R3	169Ω	1690	301Ω	3010	536Ω	5360	953Ω	9530
17.4Ω	17R4	30.9Ω	30R9	54.9Ω	54R9	97.6Ω	97R6	174Ω	1740	309Ω	3090	549Ω	5490	976Ω	9760

标准阻值 Standard Nominal Resistance Values

阻值 Value	代码 Code	阻值 Value	代码 Code	阻值 Value	代码 Code	阻值 Value	代码 Code	阻值 Value	代码 Code	阻值 Value	代码 Code	阻值 Value	代码 Code	阻值 Value	代码 Code
1.00K	1001	2.37K	2371	5.62K	5621	13.3K	1332	31.6K	3162	75.0K	7502	178K	1783	422K	4223
1.02K	1021	2.43K	2431	5.76K	5761	13.7K	1372	32.4K	3242	76.8K	7682	182K	1823	432K	4323
1.05K	1051	2.49K	2491	5.90K	5901	14.0K	1402	33.2K	3322	78.7K	7872	187K	1873	442K	4423
1.07K	1071	2.55K	2551	6.04K	6041	14.3K	1432	34.0K	3402	80.6K	8062	191K	1913	453K	4533
1.10K	1101	2.61K	2611	6.19K	6191	14.7K	1472	34.8K	3482	82.5K	8252	196K	1963	464K	4643
1.13K	1131	2.67K	2671	6.34K	6341	15.0K	1502	35.7K	3572	84.5K	8452	200K	2003	475K	4753
1.15K	1151	2.74K	2741	6.49K	6491	15.4K	1542	36.5K	3652	86.6K	8662	205K	2053	487K	4873
1.18K	1181	2.80K	2801	6.65K	6651	15.8K	1582	37.4K	3742	88.7K	8872	210K	2103	499K	4993
1.21K	1211	2.87K	2871	6.81K	6811	16.2K	1622	38.3K	3832	90.9K	9092	215K	2153	511K	5113
1.24K	1241	2.94K	2941	6.98K	6981	16.5K	1652	39.2K	3922	93.1K	9312	221K	2213	523K	5233
1.27K	1271	3.01K	3011	7.15K	7151	16.9K	1692	40.2K	4022	95.3K	9532	226K	2263	536K	5363
1.30K	1301	3.09K	3091	7.32K	7321	17.4K	1742	41.2K	4122	97.6K	9762	232K	2323	549K	5493
1.33K	1331	3.16K	3161	7.50K	7501	17.8K	1782	42.2K	4222	100K	1003	237K	2373	562K	5623
1.37K	1371	3.24K	3241	7.68K	7681	18.2K	1822	43.2K	4322	102K	1023	243K	2433	576K	5763
1.40K	1401	3.32K	3321	7.87K	7871	18.7K	1872	44.2K	4422	105K	1053	249K	2493	590K	5903
1.43K	1431	3.40K	3401	8.06K	8061	19.1K	1912	45.3K	4532	107K	1073	255K	2553	604K	6043
1.47K	1471	3.48K	3481	8.25K	8251	19.6K	1962	46.4K	4642	110K	1103	261K	2613	619K	6193
1.50K	1501	3.57K	3571	8.45K	8451	20.0K	2002	47.5K	4752	113K	1133	267K	2673	634K	6343
1.54K	1541	3.65K	3651	8.66K	8661	20.5K	2050	48.7K	4872	115K	1153	274K	2743	649K	6493
1.58K	1581	3.74K	3741	8.87K	8871	21.0K	2102	49.9K	4992	118K	1183	280K	2803	665K	6653
1.62K	1621	3.83K	3831	9.09K	9091	21.5K	2152	51.1K	5112	121K	1213	287K	2873	681K	6813
1.65K	1651	3.92K	3921	9.31K	9311	22.1K	2212	52.3K	5232	124K	1243	294K	2943	698K	6983
1.69K	1691	4.02K	4021	9.53K	9531	22.6K	2262	53.6K	5362	127K	1273	301K	3013	715K	7153
1.74K	1741	4.12K	4121	9.76K	9761	23.2K	2322	54.9K	5492	130K	1303	309K	3093	732K	7323
1.78K	1781	4.22K	4221	10.0K	1002	23.7K	2372	56.9K	5692	133K	1333	316K	3163	750K	7503
1.82K	1821	4.32K	4321	10.2K	1022	24.3K	2432	57.6K	5762	137K	1373	324K	3243	768K	7683
1.87K	1871	4.42K	4421	10.5K	1052	24.9K	2492	59.0K	5902	140K	1403	332K	3323	787K	7873
1.91K	1911	4.53K	4531	10.7K	1072	25.5K	2552	60.4K	6042	143K	1433	340K	3403	806K	8063
1.96K	1961	4.64K	4641	11.0K	1102	26.1K	2612	61.9K	6192	147K	1473	348K	3483	825K	8253
2.00K	2001	4.75K	4751	11.3K	1132	26.7K	2672	63.4K	6342	150K	1503	357K	3573	845K	8453
2.05K	2051	4.87K	4871	11.5K	1152	27.4K	2742	64.9K	6492	154K	1543	365K	3653	866K	8663
2.10K	2101	4.99K	4991	11.8K	1182	28.0K	2802	66.5K	6652	158K	1583	374K	3743	887K	8873
2.15K	2151	5.11K	5111	12.1K	1212	28.7K	2872	68.1K	6812	162K	1623	383K	3833	909K	9093
2.21K	2211	5.23K	5231	12.4K	1242	29.4K	2942	69.8K	6982	165K	1653	392K	3923	931K	9313
2.26K	2261	5.36K	5361	12.7K	1272	30.1K	3012	71.5K	7152	169K	1693	402K	4023	953K	9533
2.32K	2321	5.49K	5491	13.0K	1302	30.9K	3092	73.2K	7322	174K	1743	412K	4123	976K	9763
以上所有阻值都是标准阻值，其他阻值可以特别提供，但有相应MOQ之要求。 All values shown above are standard resistance values, other values could also be provided on a case to case basis (MOQ requested)														1M	1004

特性 Features

适合贴片机组装 Suitable for SMT

符合RoHS和无卤标准 Meet RoHS & HF Requirement

低阻值，适合大电流通过 Low Resistance & Suitable for Large Current Application

超低阻值 Ultra-low Value

应用 Application

电源供应器 Power supply

DC-DC转换器，电池组，充电器，适配器 DC-DC Converter, Battery Pack, Charger, Adaptor

构造 Construction

阻值300mΩ (不含) 以上结构

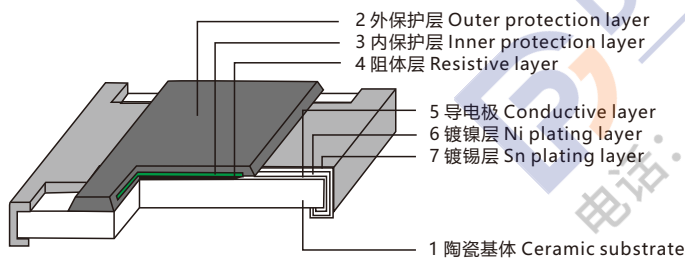

阻值300mΩ (含) 以下结构

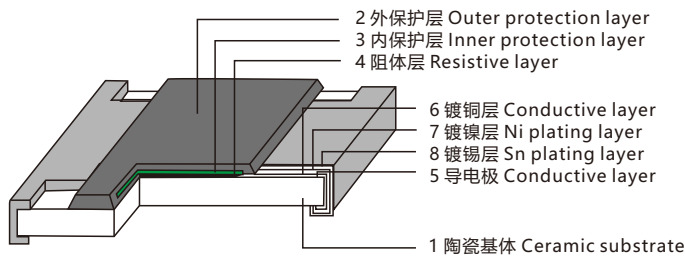

功率衰减曲线 Power Derating Curve

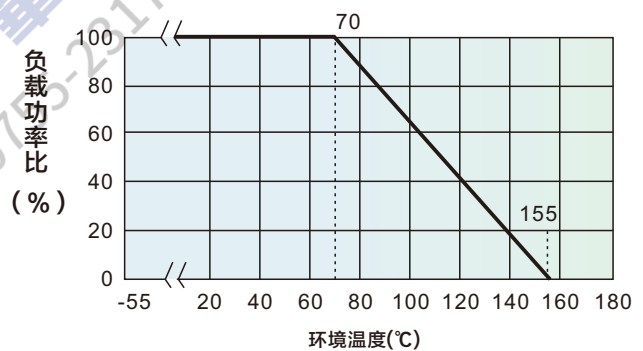

订货方式 (例如1206 5% 1/4W 300mΩ)

Ordering Procedure (Example 1206 5% 1/4W 300mΩ)

料号 (Part Number) : CR1206J4R300G

CR	1206	J	4	R300	G
类型 (Type) CR: 厚膜贴片电阻 (Thick Film Chip Resistors)	尺寸 (Size) 0402 0603 0805 1206 1210 2010 2512	公差 Tolerance F = ±1% J = ±5%	额定功率 Rated Power 1 = 1W 2 = 3/4W 3 = 1/2W 4 = 1/4W 8 = 1/8W A = 1/10W F = 1/16W	阻值 Resistance Value <100mΩ(不含) R010=10mΩ R082=82mΩ ≥100mΩ(含) R300=300mΩ R470=470mΩ	包装代码 Packing Code G = Reel (卷装) S = 10 inch reel 卷装 U = 13 inch reel 卷装 V = bulk (散料)

特性 Characteristics

类型 Type	CR0402	CR0603	CR0805	CR1206	CR1210	CR2010	CR2512
额定功率 70°C Rated Power at 70°C	1/16W	1/10W	1/8W	1/4W	1/2W	3/4W	1W
最大工作电流 Max Working Current	1.58A	3.16A	3.54A	5.00A	7.07A	8.66A	10.00A
最大过负荷电流 Max Overload Current	3.95A	7.91A	8.84A	12.50A	17.67A	21.65A	25.00A
绝缘耐压 Dielectric WithStanding Voltage	150V	220V	430V	570V	710V	710V	710V
操作温度范围 Operating Temperature	-55 ~ +155°C	-55 ~ +155°C	-55 ~ +155°C	-55 ~ +155°C	-55 ~ +155°C	-55 ~ +155°C	-55 ~ +155°C
1%阻值范围 Resistance Range of 1%	0.025Ω-1Ω	0.02Ω-1Ω	0.02Ω-1Ω	0.02Ω-1Ω	0.02Ω-1Ω	0.02Ω-1Ω	0.02Ω-1Ω
5%阻值范围 Resistance Range of 5%	0.025Ω-1Ω	0.01Ω-1Ω	0.01Ω-1Ω	0.01Ω-1Ω	0.01Ω-1Ω	0.01Ω-1Ω	0.01Ω-1Ω

外形尺寸 Dimension

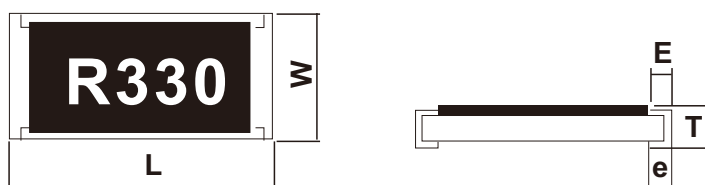

类型 Type		CR0402	CR0603	CR0805	CR1206	CR1210	CR2010	CR2512
尺寸 Dimension	L(mm)	1.00±0.05	1.60±0.10	2.00±0.15	3.10±0.15	3.10±0.15	5.00±0.20	6.25±0.20
	W(mm)	0.50±0.05	0.80±0.10	1.25±0.15	1.60±0.15	2.50±0.15	2.50±0.20	3.10±0.20
	T(mm)	0.30±0.05	0.45±0.10	0.50±0.10	0.55±0.10	0.55±0.15	0.55±0.15	0.55±0.15
	E(mm)	0.15±0.10	0.25±0.20	0.35±0.20	0.45±0.25	0.35±0.25	0.65±0.25	0.85±0.25
	e(mm)	0.20±0.10	0.30±0.20	0.40±0.20	0.40±0.25	0.60±0.25	0.50±0.25	0.95±0.25

性能 Performance Specifications

内容 Item	测试方法 Test Methods	规格 Specification Limits
温度系数 Temperature Coefficient	JIS C5201 4.8	0.01Ω-0.03Ω (含) : ±1500PPM/°C 0.03-0.1Ω (含) : ±1000PPM/°C 0.1Ω-0.5Ω (含) : ±800PPM/°C > 0.5Ω: ±600PPM/°C
焊锡性 Solderability	JIS C5201 4.17	最少95%面积上锡 Min 95% coverage
绝缘电阻 Insulation Resistance	JIS C5201 4.6	> 10GΩ
绝缘耐压 Dielectric Withstanding Voltage	JIS C5201 4.7	无击穿、飞弧及可见机械性损伤 No evidence of flashover, mechanical damage arcing or insulation breakdown
短时间过负荷 Short-Time Overload	JIS C5201 4.13	±(2.0%+0.001Ω)Max(最大)
端子弯曲 Terminal Bending	JIS C5201 4.33	±(2.0%+0.001Ω)Max(最大)
抗焊锡热 Resist to Soldering Heat	JIS C5201 4.18	±(1.0%+0.001Ω)Max(最大)
负荷寿命 Load Life	JIS C5201 4.25.1	±(3.0%+0.001Ω)Max(最大)
耐湿特性 Humidity	JIS C5201 4.24	±(2.0%+0.001Ω)Max(最大)
温度循环 Temperature Cycling	JIS C5201 4.19	±(2.0%+0.001Ω)Max(最大)
温湿循环 Moisture Resistance	MIL-STD-202 METHOD106	±(2.0%+0.001Ω)Max(最大)

字码表示规则(10mΩ ~ 910mΩ):

R-value	0805以上 Code	0603 Code	R-value	0805以上 Code	0603 Code	R-value	0805以上 Code	0603 Code
10mΩ	R010	010	100mΩ	R100	R10	360mΩ	R360	R36
15mΩ	R015	015	110mΩ	R110	R11	390mΩ	R390	R39
20mΩ	R020	020	120mΩ	R120	R12	400mΩ	R400	R40
25mΩ	R025	025	130mΩ	R130	R13	430mΩ	R430	R43
30mΩ	R030	030	150mΩ	R150	R15	470mΩ	R470	R47
40mΩ	R040	040	160mΩ	R160	R16	500mΩ	R500	R50
50mΩ	R050	050	180mΩ	R180	R18	510mΩ	R510	R51
56mΩ	R056	056	200mΩ	R200	R20	560mΩ	R560	R56
62mΩ	R062	062	220mΩ	R220	R22	620mΩ	R620	R62
68mΩ	R068	068	240mΩ	R240	R24	680mΩ	R680	R68
75mΩ	R075	075	270mΩ	R270	R27	750mΩ	R750	R75
82mΩ	R082	082	300mΩ	R300	R30	820mΩ	R820	R82
91mΩ	R091	091	330mΩ	R330	R33	910mΩ	R910	R91

注:

0402及以下规格: 无字码表示

0603规格: $\pm 1\%$ (F)、 $\pm 5\%$ (J)均采用“三码”表示方式

如: 阻值100mΩ = 0.10Ω = R100 = R10表示

阻值10mΩ = 0.010Ω = R010 = 010表示

0805及以上规格: $\pm 1\%$ (F)、 $\pm 5\%$ (J)均采用“四码”表示方式

如: 阻值100mΩ = 0.10Ω = R100 = R100表示

阻值10mΩ = 0.010Ω = R010 = R010表示

特性 Features

适合贴片机组装 Suitable for SMT

符合RoHS和无卤标准 Meet RoHS & HF Requirement

电极强化, 更符合柔性线路板应用 Strengthened terminals & Suitable for Special Flexible PCB

应用 Application

软性电路板 Soft Circuit board

软灯条电路 Soft lamp circuit

构造 Construction

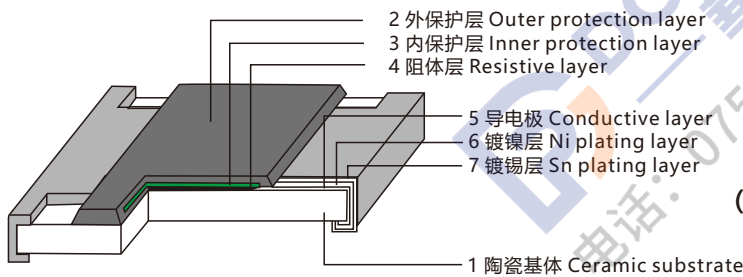

功率衰减曲线 Power Derating Curve

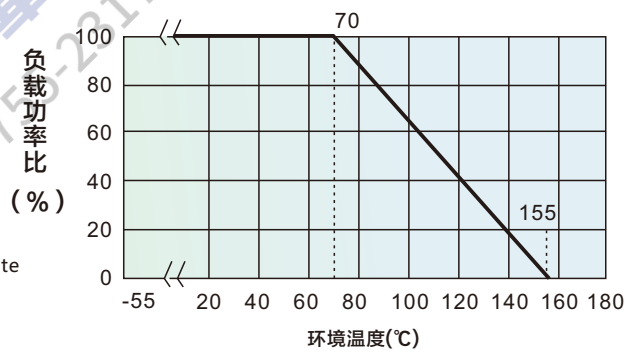

订货方式 (例如:1206 5% 1/4W 150R)

Ordering Procedure (Example: 1206 5% 1/4W 150R)

料号 (Part Number) : CR1206J40151G

CR	1206	J	4	0151	G
类型 (Type) CR: 厚膜贴片电阻 (Thick Film Chip Resistors)	尺寸 (Size) 0805 1206	公差 Tolerance F=±1% G=±2% J=±5%	额定功率 Rated Power 4=1/4W 8=1/8W	阻值 Resistance Value ±5%, ±2% 0151=150Ω ±1% 1002=10KΩ	包装代码 Packing Code G=Reel(卷装) V=Bulk (散料) S=Double Standard Quantity (两倍卷盘标准 包装量)

特性 Characteristics

类型 Type	额定功率 Rated Power at 70°C	最大工作电压 Max Working Voltage	最大过负荷 电压 Max Overload Voltage	绝缘耐压 Dielectric WithStanding Voltage	操作温度范围 Operating Temperature	1%阻值范围 Resistance Range of 1%	2%阻值范围 Resistance Range of 2%	5%阻值范围 Resistance Range of 5%
CR0805	1/8W	150V	300V	430V	-55 ~ +155°C	10Ω~10K	10Ω~10K	10Ω~10K
CR1206	1/4W	200V	400V	570V	-55 ~ +155°C	10Ω~10K	10Ω~10K	10Ω~10K

外形尺寸 Dimension

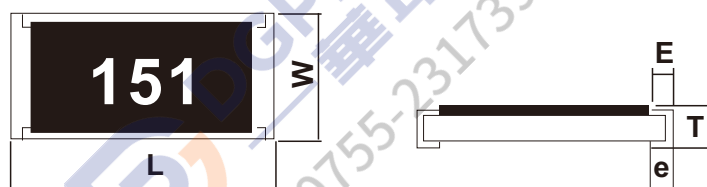

类型 Type	L(mm)	W(mm)	T(mm)	E(mm)	e(mm)
CR0805	2.00±0.15	1.25±0.15	0.50±0.10	0.35±0.20	0.40±0.20
CR1206	3.10±0.15	1.60±0.15	0.55±0.10	0.45±0.25	0.40±0.25

性能 Performance Specifications

内容 Item	测试方法 Test Methods	规格 Specification Limits
温度系数 Temperature Coefficient	JIS C5201 4.8	10Ω < R ≤ 10KΩ: ±100 PPM/°C
焊锡性 Solderability	JIS C5201 4.17	最少95%面积上锡 Min 95% coverage
绝缘电阻 Insulation Resistance	JIS C5201 4.6	> 10GΩ
绝缘耐压 Dielectric Withstanding Voltage	JIS C5201 4.7	无击穿、飞弧及可见机械性损伤 No evidence of flashover, mechanical damage arcing or insulation breakdown
短时间过负荷 Short-Time Overload	JIS C5201 4.13	±(1.0%+0.05Ω)Max(最大)
端子弯曲 Terminal Bending	JIS C5201 4.33	±(1.0%+0.05Ω)Max(最大)
抗焊锡热 Resist to Soldering Heat	JIS C5201 4.18	±(1.0%+0.05Ω)Max(最大)
负荷寿命 Load Life	JIS C5201 4.25.1	±(2.0%+0.05Ω)Max(最大)
耐湿特性 Humidity	JIS C5201 4.24	±(2.0%+0.05Ω)Max(最大)
温度循环 Temperature Cycling	JIS C5201 4.19	±(2.0%+0.05Ω)Max(最大)
温湿循环 Moisture Resistance	MIL-STD-202 METHOD106	±(2.0%+0.05Ω)Max(最大)

特性 Features

适合贴片机组装 Suitable for SMT
多电阻排列，节约空间 More resistors arrayed in one & Space Saving
符合RoHS和无卤标准 Meet RoHS & HF Requirement

应用 Application

应用于CD、DVD、硬盘、内存、主板等
Master board, CD&DVD Rom, Hard Disk, RAM

功率衰减曲线 Power Derating Curve

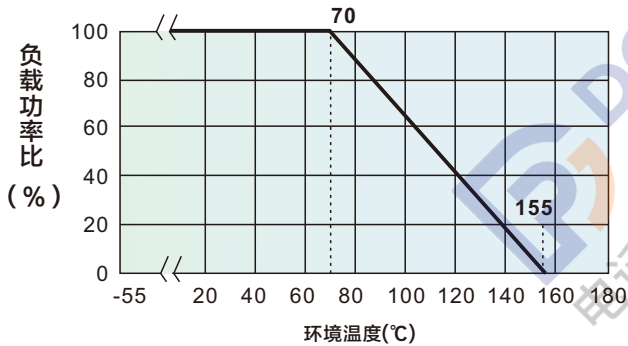

订货方式 (例如CA034A 5% 1/10W 1KΩ)

Ordering Procedure (Example CA034A 5% 1/10W 1KΩ)

料号 (Part Number) : CA034AJA0102G

CA	034A	J	A	0102	G
类型 (Type) CA:厚膜贴片排阻 (Thick Film Chip Array Resistors)	尺寸 (Size) 024A=8P4R(0402) 034A=8P4R(0603)	公差 Tolerance F=±1% G=±2% J=±5%	额定功率 Rated Power A=1/10W F=1/16W	阻值 Resistance Value ±1% 49R9=49.9Ω 1002=10KΩ ±2%, ±5%, 06R8=6.8Ω 0564=560KΩ	包装代码 Packing Code G=Reel(卷装) V=Bulk (散料) S=Double Standard Quantity (两倍 卷盘标准包装量)

标准包装数量 Standard Packing Quantity

CA024A: 10,000Pcs Per Reel(每卷10, 000Pcs)

CA034A: 5,000Pcs Per Reel(每卷5, 000Pcs)

特性 Characteristics

类型 Type	CA024A	CA034A
额定功率 70°C Rated Power at 70°C	1/16W	1/10W
最大工作电压 Max Working Voltage	50V	50V
最大过负荷电压 Max Overload Voltage	100V	100V
绝缘耐压 Dielectric WithStanding Voltage	220V	430V
操作温度范围 Operating Temperature	-55 ~ +155°C	-55 ~ +155°C
零欧姆电阻阻值 Resistance Value of Jumper	< 50mΩ	< 50mΩ
零欧姆额定电流 Rated Current of Jumper	1A	1A
1% 2% 5%阻值范围 Resistance Range of 1% 2% 5%	1Ω-1MΩ	1Ω-1MΩ

外形尺寸 Dimension

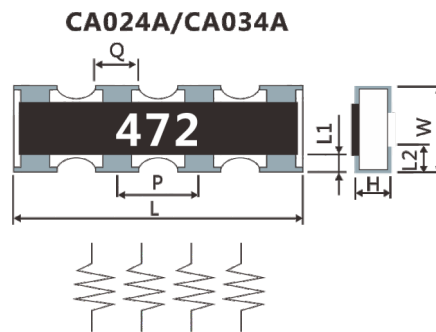

类型 Type		CA024A	CA034A
尺寸 Dimension	L(mm)	2.00±0.10	3.20±0.20
	W(mm)	1.00±0.10	1.50±0.20
	H(mm)	0.40±0.05	0.55±0.05
	L1(mm)	0.18±0.10	0.30±0.15
	Q(mm)	0.33±0.10	0.50±0.15
	P(mm)	0.50±0.10	0.80±0.15
	L2(mm)	0.26±0.10	0.30±0.20

性能 Performance Specifications

内容 Item	测试方法 Test Methods	规格 Specification Limits
温度系数 Temperature Coefficient	JIS C5201 4.8	± 200 PPM/ $^{\circ}$ C
焊锡性 Solderability	JIS C5201 4.17	最少95%面积上锡 Min 95% coverage
绝缘电阻 Insulation Resistance	JIS C5201 4.6	$> 10G\Omega$
绝缘耐压 Dielectric Withstanding Voltage	JIS C5201 4.7	无击穿、飞弧及可见机械性损伤 No evidence of flashover, mechanical damage arcing or insulation breakdown
短时间过负荷 Short-Time Overload	JIS C5201 4.13	$\pm (1.0\% + 0.05\Omega)$ Max(最大)
端子弯曲 Terminal Bending	JIS C5201 4.33	$\pm (1.0\% + 0.05\Omega)$ Max(最大)
抗焊锡热 Resist to Soldering Heat	JIS C5201 4.18	$\pm (1.0\% + 0.05\Omega)$ Max(最大)
负荷寿命 Load Life	JIS C5201 4.25.1	$\pm (2.0\% + 0.05\Omega)$ Max(最大)
耐湿特性 Humidity	JIS C5201 4.24	$\pm (2.0\% + 0.05\Omega)$ Max(最大)
温度循环 Temperature Cycling	JIS C5201 4.19	$\pm (2.0\% + 0.05\Omega)$ Max(最大)
温湿循环 Moisture Resistance	MIL-STD-202 METHOD106	$\pm (2.0\% + 0.05\Omega)$ Max(最大)

特性 Features

适合贴片机组装 Suitable for SMT
 符合RoHS和无卤标准 Meet RoHS & HF Requirement
 高功率 High Power

应用 Application

开关电源 Switching power supply
 电压调节器 Voltage regulator
 电源转换器 Power converter
 充电器 Charger

构造 Construction

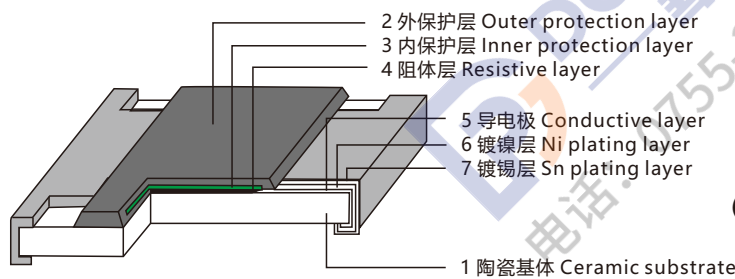

功率衰减曲线 Power Derating Curve

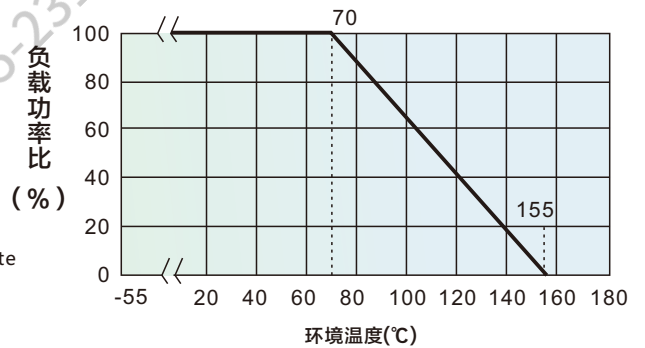

订货方式 (例如0805 5% 1/4W 100Ω)

Ordering Procedure (Example 0805 5% 1/4W 100Ω)

料号 (Part Number) : CH0805J40101G

CH	0805	J	4	0101	G
类型 (Type) CH:高功率厚膜贴片电阻 (High Power Thick Chip Resistors)	尺寸 (Size) 0402 0603 0805 1206 1210 2010 2512	公差 Tolerance D=±0.5% F=±1% G=±2% J=±5%	额定功率 Rated Power 1=1W 2=3/4W 3=1/2W 4=1/4W 8=1/8W A=1/10W B=2W	阻值 Resistance Value ±1% 49R9=49.9Ω 1002=10KΩ ±2%, ±5%, 06R8=6.8Ω 0564=560KΩ	包装代码 Packing Code G=Reel (卷装) V=Bulk (散料) S=Double Standard Quantity (两倍卷盘标准包装量)

标准包装数量 Standard Packing Quantity

0402: 10,000Pcs Per Reel (每卷10, 000Pcs)
 0603/0805/1206: 5,000Pcs Per Reel (每卷5, 000Pcs)
 2010/2512: 4,000Pcs Per Reel (每卷4, 000Pcs)

特性 Characteristics

类型 Type	CH0402	CH0603	CH0805	CH1206	CH1210	CH2010	CH2512
额定功率 70°C Rated Power at 70°C	1/10W	1/8W	1/4W	1/2W	3/4W	1W	2W
最大工作电压 Max Working Voltage	50V	75V	150V	200V	200V	200V	200V
最大过负荷电压 Max Overload Voltage	100V	150V	300V	400V	500V	500V	500V
绝缘耐压 Withstanding Voltage Dielectric	150V	220V	430V	570V	710V	710V	710V
操作温度范围 Operating Temperature	-55 ~ +155°C	-55 ~ +155°C	-55 ~ +155°C	-55 ~ +155°C	-55 ~ +155°C	-55 ~ +155°C	-55 ~ +155°C
零欧姆电阻阻值 Resistance Value of Jumper	< 50mΩ	< 50mΩ	< 50mΩ	< 50mΩ	< 50mΩ	< 50mΩ	< 50mΩ
零欧姆电阻最大电流 Max Current of Jumper	3.53A	3.95A	5.59A	10.00A	12.00A	12.00A	16.00A
0.5%阻值范围 Resistance Range of 0.5%	1Ω-1MΩ	1Ω-1MΩ	1Ω-1MΩ	1Ω-1MΩ	1Ω-1MΩ	1Ω-1MΩ	1Ω-1MΩ
1%阻值范围 Resistance Range of 1%	1Ω-22MΩ	1Ω-22MΩ	1Ω-22MΩ	1Ω-22MΩ	1Ω-22MΩ	1Ω-22MΩ	1Ω-22MΩ
2%阻值范围 Resistance Range of 2%	1Ω-22MΩ	1Ω-22MΩ	1Ω-22MΩ	1Ω-22MΩ	1Ω-22MΩ	1Ω-22MΩ	1Ω-22MΩ
5%阻值范围 Resistance Range of 5%	1Ω-22MΩ	1Ω-22MΩ	1Ω-22MΩ	1Ω-22MΩ	1Ω-22MΩ	1Ω-22MΩ	1Ω-22MΩ

外形尺寸 Dimension

形状 Figures

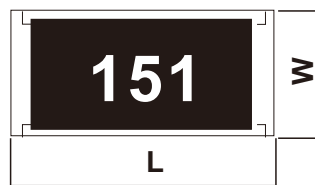

类型 Type		CH0402	CH0603	CH0805	CH1206	CH1210	CH2010	CH2512
尺寸 Dimension	L(mm)	1.00±0.05	1.60±0.10	2.00±0.15	3.10±0.15	3.10±0.15	5.00±0.20	6.25±0.20
	W(mm)	0.50±0.05	0.80±0.10	1.25±0.15	1.60±0.15	2.50±0.15	2.50±0.20	3.10±0.20
	T(mm)	0.30±0.05	0.45±0.10	0.50±0.10	0.55±0.10	0.55±0.15	0.55±0.15	0.55±0.15
	E(mm)	0.15±0.10	0.25±0.20	0.35±0.20	0.45±0.25	0.35±0.25	0.65±0.25	0.85±0.25
	e(mm)	0.20±0.10	0.30±0.20	0.40±0.20	0.40±0.25	0.60±0.25	0.50±0.25	0.95±0.25

性能 Performance Specifications

内容 Item	测试方法 Test Methods	规格 Specification Limits
温度系数 Temperature Coefficient	JIS C5201 4.8	$1\Omega \leq R \leq 10\Omega$: $\pm 200\text{PPM}/^\circ\text{C}$ $10\Omega < R \leq 10\text{M}\Omega$: $\pm 100\text{PPM}/^\circ\text{C}$ $10\text{M}\Omega < R \leq 100\text{M}\Omega$: $\pm 200\text{PPM}/^\circ\text{C}$
焊锡性 Solderability	JIS C5201 4.17	最少95%面积上锡 Min 95% coverage
绝缘电阻 Insulation Resistance	JIS C5201 4.6	$> 10\text{G}\Omega$
绝缘耐压 Dielectric Withstanding Voltage	JIS C5201 4.7	无击穿、飞弧及可见机械性损伤 No evidence of flashover, mechanical damage arcing or insulation breakdown
短时间过负荷 Short-Time Overload	JIS C5201 4.13	$\pm (1.0\% + 0.05\Omega)\text{Max(最大)}$
端子弯曲 Terminal Bending	JIS C5201 4.33	$\pm (1.0\% + 0.05\Omega)\text{Max(最大)}$
抗焊锡热 Resist to Soldering Heat	JIS C5201 4.18	$\pm (1.0\% + 0.05\Omega)\text{Max(最大)}$
负荷寿命 Load Life	JIS C5201 4.25.1	$\pm (2.0\% + 0.05\Omega)\text{Max(最大)}$
耐湿特性 Humidity	JIS C5201 4.24	$\pm (2.0\% + 0.05\Omega)\text{Max(最大)}$
温度循环 Temperature Cycling	JIS C5201 4.19	$\pm (2.0\% + 0.05\Omega)\text{Max(最大)}$
湿湿循环 Moisture Resistance	MIL-STD-202 METHOD106	$\pm (2.0\% + 0.05\Omega)\text{Max(最大)}$

特性 Features

- 适合贴片机组装 Suitable for SMT
- 符合RoHS和无卤标准 Meet RoHS & HF Requirement
- 符合AEC-Q200标准 Comply with AEC-Q200 standard
- 此类型电阻在包装前100%通过自动光学检测 The resistors are 100% performed by automatic optical inspection prior to taping

应用 Application

- 汽车电子 Automotive electronics
- 电信设备 Telecommunications equipment
- 电源电压控制 Voltage control in power supplies
- 测试和测量设备 Test & Measurement equipment

构造 Construction

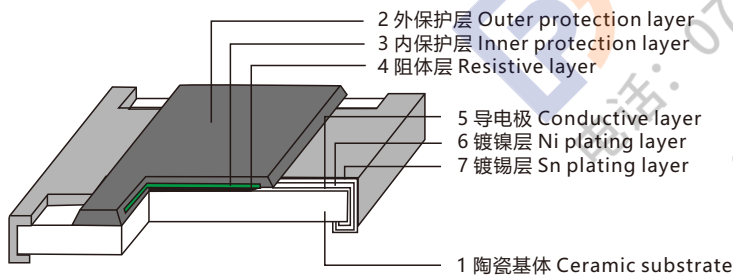

功率衰减曲线 Power Derating Curve

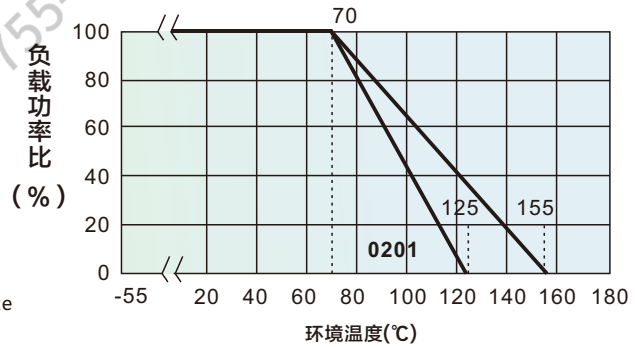

订货方式 (例如 0603 5% 1/10W 100Ω)

Ordering Procedure (Example 0603 5% 1/10W 100Ω)

料号 (Part Number) : AQ0603JA0101G

AQ	0603	J	A	0101	G
类型 (Type) AQ:汽车厚膜贴片电阻 (Automotive Thick Film Chip Resistors)	尺寸 (Size) 0201 0402 0603 0805 1206 1210 2010 2512	公差 Tolerance F=±1% G=±2% J=±5%	额定功率 Rated Power 1=1W 2=3/4W 3=1/2W 4=1/4W 8=1/8W A=1/10W F=1/16W H=1/20W	阻值 Resistance Value ±1%; 49R9=49.9Ω 1002=10KΩ ±5%; ±2% 06R8=6.8Ω 0564=560KΩ	包装代码 Packing Code G=Reel(卷装) V=Bulk (散料) S=Double Standard Quantity (两倍卷盘标准包装量)

特性 Characteristics

类型 Type	AQ0201	AQ0402	AQ0603	AQ0805	AQ1206	AQ1210	AQ2010	AQ2512
额定功率 70°C Rated Power at 70°C	1/20W	1/16W	1/10W	1/8W	1/4W	1/2W	3/4W	1W
最大工作电压 Max Working Voltage	25V	50V	75V	150V	200V	200V	200V	200V
最大过负荷电压 Max Overload Voltage	50V	100V	150V	300V	400V	500V	500V	500V
绝缘耐压 WithStanding Voltage Dielectric	75V	150V	220V	430V	570V	710V	710V	710V
操作温度范围 Operating Temperature	-55 ~ +125°C	-55 ~ +155°C	-55 ~ +155°C	-55 ~ +155°C	-55 ~ +155°C	-55 ~ +155°C	-55 ~ +155°C	-55 ~ +155°C
零欧姆电阻阻值 Resistance Value of Jumper	< 50mΩ	< 50mΩ	< 50mΩ	< 50mΩ	< 50mΩ	< 50mΩ	< 50mΩ	< 50mΩ
零欧姆额定电流 Rated Current of Jumper	0.5A	1.0A	1.0A	2.0A	2.0A	2.0A	2.0A	2.0A
零欧姆最大电流 Max Current of jumper	1.0A	2.0A	2.0A	5.0A	10.0A	10.0A	10.0A	10.0A
1%阻值范围 Resistance Range of 1%	1Ω-10MΩ	1Ω-22MΩ	1Ω-22MΩ	1Ω-22MΩ	1Ω-22MΩ	1Ω-22MΩ	1Ω-22MΩ	1Ω-22MΩ
2%阻值范围 Resistance Range of 2%	1Ω-10MΩ	1Ω-22MΩ	1Ω-22MΩ	1Ω-22MΩ	1Ω-22MΩ	1Ω-22MΩ	1Ω-22MΩ	1Ω-22MΩ
5%阻值范围 Resistance Range of 5%	1Ω-10MΩ	1Ω-22MΩ	1Ω-22MΩ	1Ω-22MΩ	1Ω-22MΩ	1Ω-22MΩ	1Ω-22MΩ	1Ω-22MΩ

外形尺寸 Dimension

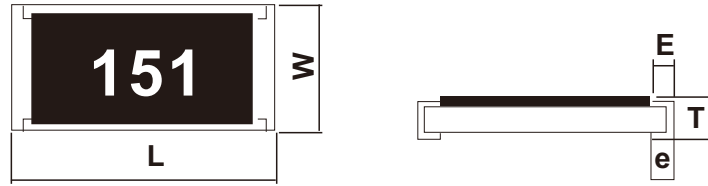

类型 Type	AQ0201	AQ0402	AQ0603	AQ0805	AQ1206	AQ1210	AQ2010	AQ2512	
尺寸 Dimension	L(mm)	0.60±0.03	1.00±0.05	1.60±0.10	2.00±0.15	3.10±0.15	3.10±0.15	5.00±0.20	6.25±0.20
	W(mm)	0.30±0.03	0.50±0.05	0.80±0.10	1.25±0.15	1.60±0.15	2.50±0.15	2.50±0.20	3.10±0.20
	T(mm)	0.23±0.03	0.30±0.05	0.45±0.10	0.50±0.10	0.55±0.10	0.55±0.15	0.55±0.15	0.55±0.15
	E(mm)	0.10±0.05	0.15±0.10	0.25±0.20	0.35±0.20	0.45±0.25	0.35±0.25	0.65±0.25	0.85±0.25
	e(mm)	0.15±0.05	0.20±0.10	0.30±0.20	0.40±0.20	0.40±0.25	0.60±0.25	0.50±0.25	0.95±0.25

性能 Performance Specifications

内容 Item	测试方法 Test Methods	规格 Specification Limits
温度系数 Temperature Coefficient	JIS C5201 4.8	0201规格: 1Ω ≤ R ≤ 10Ω: -100 ~ +300 PPM/°C 10Ω < R ≤ 10MΩ: ±200 PPM/°C 0402 ~ 2512规格: 1Ω ≤ R ≤ 10Ω: ±200 PPM/°C 10Ω < R ≤ 10MΩ: ±100 PPM/°C 10MΩ < R ≤ 100MΩ: ±200 PPM/°C
焊锡性 Solderability	J-STD-002	最少95%面积上锡 Min 95% coverage
绝缘电阻 Insulation Resistance	JIS C5201 4.6	> 10GΩ
绝缘耐压 Dielectric Withstanding Voltage	JIS C5201 4.7	无击穿、飞弧及可见机械性损伤 No evidence of flashover, mechanical damage arcing or insulation breakdown
短时间过负荷 Short-Time Overload	JIS C5201 4.13	±(1.0% + 0.05Ω) Max(最大)
端子弯曲 Board Flex	AEC-Q200-005	±(1.0% + 0.05Ω) Max(最大)
抗焊锡热 Resistance to Soldering Heat	MIL-STD-202 METHOD 210	±(1.0% + 0.05Ω) Max(最大)
负荷寿命 Operational Life	MIL-STD-202 METHOD 108	±(2.0% + 0.05Ω) Max(最大)
耐湿特性 Biased Humidity	MIL-STD-202 METHOD 103	±(2.0% + 0.05Ω) Max(最大)
温度循环 Temperature Cycling	JESD22 METHOD JA-104	±(2.0% + 0.05Ω) Max(最大)
温湿循环 Moisture resistance	MIL-STD-202 METHOD 106	±(2.0% + 0.05Ω) Max(最大)
高温储存 High Temperature Exposure(Storage)	MIL-STD-202 METHOD 108	±(1.0% + 0.05Ω) Max(最大)
ESD试验 ESD test	AEC-Q200-002	±(3.0% + 0.05Ω) Max(最大)
抗硫化试验 Sulfurston Test	ASTM-B-809-95	±(1.0% + 0.05Ω) Max(最大)

特性 Features

- 适合贴片机组装 Suitable for SMT
- 符合RoHS和无卤标准 Meet RoHS & HF Requirement
- 优越的抗硫化特性 Superior resistance against sulfur containing atmosphere
- 符合AEC-Q200标准 Comply with AEC-Q200 standard

应用 Application

- 汽车电子 Automotive electronics
- 自动化设备控制器 Automatic Equipment Controller
- 医疗设备 Medical Equipment
- 户外电子应用 Outdoor Electronic Applications

构造 Construction

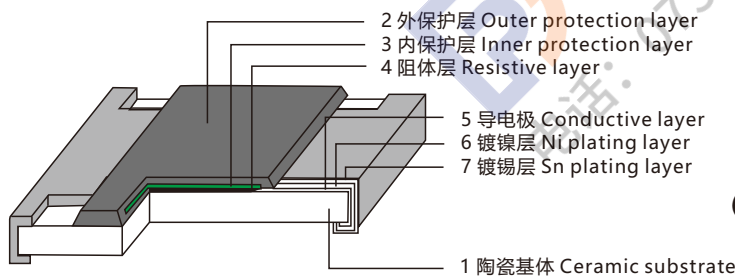

功率衰减曲线 Power Derating Curve

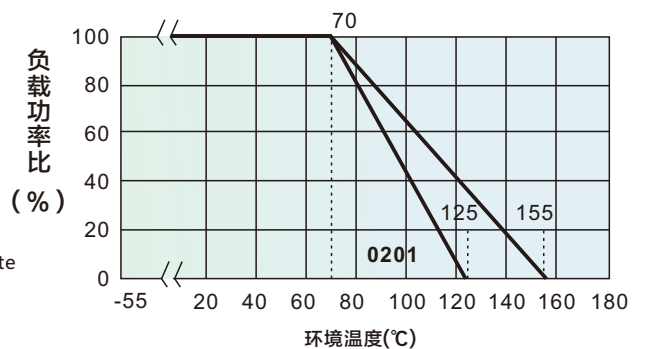

订货方式 (例如 0603 5% 1/10W 100Ω)

Ordering Procedure (Example 0603 5% 1/10W 100Ω)

料号 (Part Number) : AS0603JA0101G

AS	0603	J	A	0101	G
类型 (Type) AS:抗硫化厚膜贴片电阻 (Anti-Sulfuration Thick Film Chip Resistors)	尺寸 (Size) 0201 0402 0603 0805 1206 1210 2010 2512	公差 Tolerance F=±1% G=±2% J=±5%	额定功率 Rated Power 1=1W 2=3/4W 3=1/2W 4=1/4W 8=1/8W A=1/10W F=1/16W H=1/20W	阻值 Resistance Value 1%: 49R9=49.9Ω 1002=10KΩ ±5%; ±2% 06R8=6.8Ω 0564=560KΩ	包装代码 Packing Code G=Reel(卷装) V=Bulk(散料) S=Double Standard Quantity (两倍卷盘标准包装量)

特性 Characteristics

类型 Type	AS0201	AS0402	AS0603	AS0805	AS1206	AS1210	AS2010	AS2512
额定功率 70°C Rated Power at 70°C	1/20W	1/16W	1/10W	1/8W	1/4W	1/2W	3/4W	1W
最大工作电压 Max Working Voltage	25V	50V	75V	150V	200V	200V	200V	200V
最大过负荷电压 Max Overload Voltage	50V	100V	150V	300V	400V	500V	500V	500V
绝缘耐压 Withstanding Voltage Dielectric	75V	150V	220V	430V	570V	710V	710V	710V
操作温度范围 Operating Temperature	-55 ~ +125°C	-55 ~ +155°C	-55 ~ +155°C	-55 ~ +155°C	-55 ~ +155°C	-55 ~ +155°C	-55 ~ +155°C	-55 ~ +155°C
零欧姆电阻阻值 Resistance Value of Jumper	< 50mΩ	< 50mΩ	< 50mΩ	< 50mΩ	< 50mΩ	< 50mΩ	< 50mΩ	< 50mΩ
零欧姆额定电流 Rated Current of Jumper	0.5A	1.0A	1.0A	2.0A	2.0A	2.0A	2.0A	2.0A
零欧姆最大电流 Max Current of jumper	1.0A	2.0A	2.0A	5.0A	10.0A	10.0A	10.0A	10.0A
1%阻值范围 Resistance Range of 1%	1Ω-10MΩ	1Ω-22MΩ	1Ω-22MΩ	1Ω-22MΩ	1Ω-22MΩ	1Ω-22MΩ	1Ω-22MΩ	1Ω-22MΩ
2%阻值范围 Resistance Range of 2%	1Ω-10MΩ	1Ω-22MΩ	1Ω-22MΩ	1Ω-22MΩ	1Ω-22MΩ	1Ω-22MΩ	1Ω-22MΩ	1Ω-22MΩ
5%阻值范围 Resistance Range of 5%	1Ω-10MΩ	1Ω-22MΩ	1Ω-22MΩ	1Ω-22MΩ	1Ω-22MΩ	1Ω-22MΩ	1Ω-22MΩ	1Ω-22MΩ

外形尺寸 Dimension

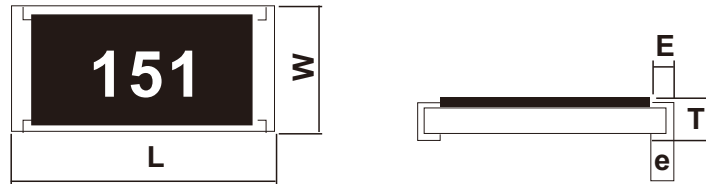

类型 Type		AS0201	AS0402	AS0603	AS0805	AS1206	AS1210	AS2010	AS2512
尺寸 Dimension	L(mm)	0.60±0.03	1.00±0.05	1.60±0.10	2.00±0.15	3.10±0.15	3.10±0.15	5.00±0.20	6.25±0.20
	W(mm)	0.30±0.03	0.50±0.05	0.80±0.10	1.25±0.15	1.60±0.15	2.50±0.15	2.50±0.20	3.10±0.20
	T(mm)	0.23±0.03	0.30±0.05	0.45±0.10	0.50±0.10	0.55±0.10	0.55±0.15	0.55±0.15	0.55±0.15
	E(mm)	0.10±0.05	0.15±0.10	0.25±0.20	0.35±0.20	0.45±0.25	0.35±0.25	0.65±0.25	0.85±0.25
	e(mm)	0.15±0.05	0.20±0.10	0.30±0.20	0.40±0.20	0.40±0.25	0.60±0.25	0.50±0.25	0.95±0.25

性能 Performance Specifications

内容 Item	测试方法 Test Methods	规格 Specification Limits
温度系数 Temperature Coefficient	JIS C5201 4.8	0201规格: 1Ω≤R≤10Ω: -100 ~ +300 PPM/°C 10Ω < R≤10MΩ: ±200 PPM/°C 0402 ~ 2512规格: 1Ω≤R≤10Ω: ±200PPM/°C 10Ω < R≤10MΩ: ±100 PPM/°C 10MΩ < R≤22MΩ: ±200 PPM/°C
焊锡性 Solderability	J-STD-002	最少95%面积上锡 Min 95% coverage
绝缘电阻 Insulation Resistance	JIS C5201 4.6	> 10GΩ
绝缘耐压 Dielectric Withstanding Voltage	JIS C5201 4.7	无击穿、飞弧及可见机械性损伤 No evidence of flashover, mechanical damage arcing or insulation breakdown
短时间过负荷 Short-Time Overload	JIS C5201 4.13	±(1.0% + 0.05Ω) Max(最大)
端子弯曲 Board Flex	AEC-Q200-005	±(1.0% + 0.05Ω) Max(最大)
抗焊锡热 Resistance to Soldering Heat	MIL-STD-202 METHOD 210	±(1.0% + 0.05Ω) Max(最大)
负荷寿命 Operational Life	MIL-STD-202 METHOD 108	±(2.0% + 0.05Ω) Max(最大)
耐湿特性 Biased Humidity	MIL-STD-202 METHOD 103	±(2.0% + 0.05Ω) Max(最大)
温度循环 Temperature Cycling	JESD22 METHOD JA-104	±(2.0% + 0.05Ω) Max(最大)
温湿循环 Moisture resistance	MIL-STD-202 METHOD 106	±(2.0% + 0.05Ω) Max (最大)
高温储存 High Temperature Exposure(Storage)	MIL-STD-202 METHOD 108	±(1.0% + 0.05Ω) Max (最大)
ESD试验 ESD test	AEC-Q200-002	±(3.0% + 0.05Ω) Max (最大)
抗硫化试验 Sulfuration Test	ASTM-B-809-95	±(3.0% + 0.05Ω) Max (最大)

特性 Features

优异的电阻温度系数 Excellent temperature coefficient characteristics
 优异的低温度电动势能 Excellent Low Thermal EMF
 产品符合RoHS与无卤要求 Products meet RoHS compliant & Halogen free requirements
 保护层材质符合UL-94-V0耐燃等级 Over-Coating meet UL-94-V0 grade

应用 Application

电源供应器 Power supply
 笔记本计算机Note Book
 汽车电子Automotives
 电池充电器Battery charger

构造 Construction

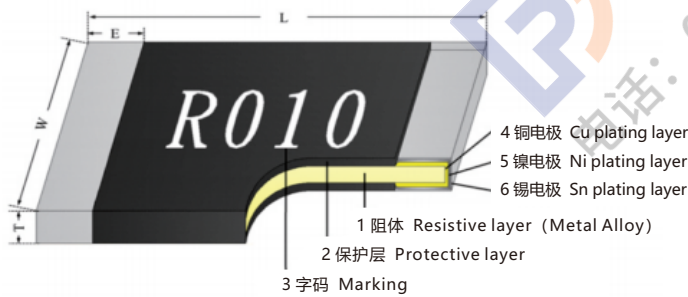

功率衰减曲线 Power Derating Curve

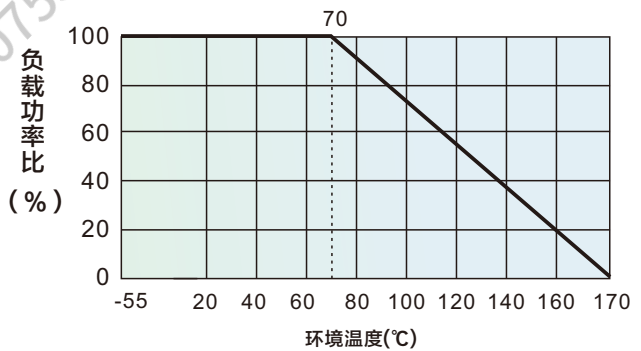

订货方式 (例如:2512 1% 2W 10mΩ)

Ordering Procedure (Example:2512 1% 2W 10mΩ)

料号 (Part Number) : RM2512FBR010GM

RM	2512	F	B	R010	G	M
类型 (Type) RM:合金贴片电阻 (Metal Current Sensing Chip Resistors)	尺寸 (Size) 1206 2512	公差 Tolerance F = ±1% G = ±2% J = ±5%	额定功率 Rated Power B = 2W D = 1.5W 1 = 1W 3 = 1/2W	阻值 Resistance Value R002 = 2mΩ R010 = 10mΩ 2L50 = 2.5mΩ	包装代码 Packing Code G=Reel(卷装) V=Bulk (散料) S=Double Standard Quantity (两倍卷盘标准包装量)	材料 Material M = MnCu N = NiCu S = CuMnSn

特性 Characteristics

类型 Type	RM1206	RM2512
额定功率 Rated Power at 70°C	1/2W、1W	1W、1.5W、2W
温度特性TCR (ppm/°C)	+25°C~+125°C: ±50	+25°C~+125°C: ±50
	+25°C~+155°C: ±65	+25°C~+155°C: ±65
绝缘耐压 Dielectric Withstanding Voltage	>100MΩ	>100MΩ
温度操作范围 Operating Temperature	-55°C~+170°C	-55°C~+170°C
阻值精度范围 Resistance Range ±1%、±2%、±5%	2mΩ~30mΩ	1mΩ~100mΩ

外形尺寸 Dimension

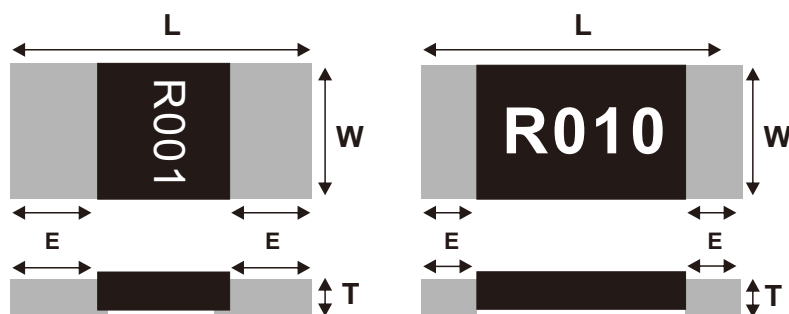

类型 Type		RM1206	RM2512
尺寸 Dimension	L(mm)	3.2±0.20	6.40±0.20
	W(mm)	1.6±0.20	3.20±0.20
	T(mm)	0.60±0.20(2mΩ≤R≤30mΩ)	0.60±0.20
	E(mm)	0.50±0.30(2mΩ≤R≤30mΩ)	2.00±0.20 (R≤2mΩ) 0.90±0.20 (R>2mΩ)

性能 Performance Specifications

内容 Item	测试方法 Test Methods	规格 Specification Limits
温度系数 Temperature Coefficient	IEC60115-1 4.8	如规格表, As Spec. +25~+125°C: $\pm 50\text{ppm}/^\circ\text{C}$ +25~+155°C: $\pm 65\text{ppm}/^\circ\text{C}$
高温储存 High Temperature Exposure(Storage)	MIL-STD-202 Method 108	$< \pm 1\%$
低温储存 Low Temperature operation	IEC60115-1 4.23.4	$< \pm 0.5\%$
温度循环 Temperature Cycling	JESD22 Method JA-104	$< \pm 0.5\%$
短时间过负荷 Short-Time Overload	IEC60115-1 4.13	$< \pm 0.5\%$
耐湿特性 Humidity	MIL-STD-202 METHOD 103	$< \pm 0.5\%$
负荷寿命 Load Life	MIL-STD-202 METHOD 108	$< \pm 1\%$
焊锡性 Solderability	J-STD-002B test B	最少95%面积上锡 Min 95% coverage
抗焊锡热 Resist to Soldering Heat	IEC60115-1 4.18	$< \pm 0.5\%$
机械冲击 Mechanical Shock	MIL-STD-202 METHOD 213	$< \pm 0.5\%$
抗振动性 Resistance to vibration	MIL-STD-202 METHOD 204	$< \pm 0.5\%$
端子弯曲 Terminal Bending	IEC 60115-1-4.33	$< \pm 0.5\%$
端子强度 Terminal Strength	IEC 60115-1-4.32	$< \pm 1\%$
冷热冲击 Thermal shock	MIL-STD-202 METHOD 107	$< \pm 0.5\%$
阻燃性 Flammability	UL-94	/
ESD试验 ESD test	IEC 61000-4-2	$< \pm 1\%$

特性 Features

- 超低电阻温度系数 Low TCR
- 超低热电动势能 Low EMF.
- 良好散热效果 Good heat dissipation.
- 符合AEC-Q200产品认证 AECQ200 qualification*

应用 Application

- 笔记本电脑 Note Book/Laptop
- 电源供应器 Power Supply
- 电池保护板 Battery Protection Module
- 变频器 Converter
- 电信设备 Telecommunications equipment
- 电源供应器 Power supply
- 汽车电子 Automotive electronics

构造 Construction

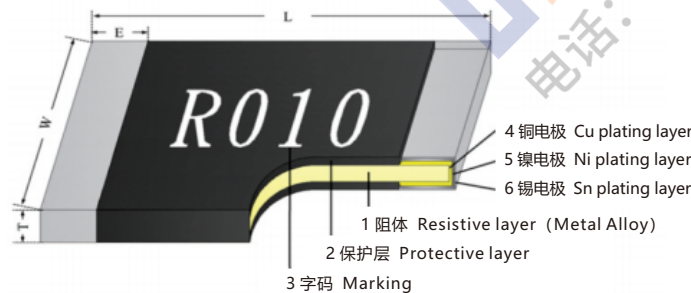

功率衰减曲线 Power Derating Curve

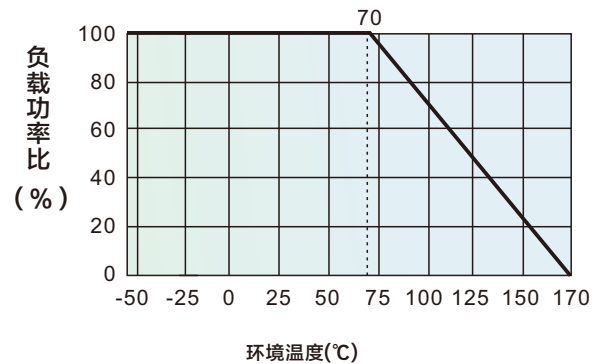

订货方式 (例如2512 2W 1% 10mΩ)

Ordering Procedure (Example 2512 2W 1% 10mΩ)

料号 (Part Number) : AM2512FBR010GM

AM	2512	F	B	R010	G	M
类型 (Type) AM: 车用合金贴片电阻 (Metal current sensing chip resistors for Automotive)	尺寸 (Size) 1206 2512	公差 Tolerance F=±1% G=±2% J=±5%	额定功率 Rated Power B= 2W D=1.5W 1= 1W 3= 1/2W	阻值 Resistance Value R001= 1mΩ R005= 5mΩ R010= 10mΩ 2L50= 2.5mΩ	包装代码 Packing Code G=Reel (卷装) V=Bulk (散料) S=Double Standard Quantity (两倍卷盘标准包装量)	材料 Material M=MnCu N=NiCu S=CuMnSn

特性 Characteristics

类型 Type	AM1206	AM2512
额定功率 70°C Rated Power at 70°C	1/2W, 1W	1W, 1.5W, 2W
温度特性 TCR (ppm/°C)	+25°C~+125°C: ±50	+25°C~+125°C: ±50
	+25°C~+155°C: ±65	+25°C~+155°C: ±65
绝缘耐压 Dielectric Withstanding Voltage	>100MΩ	>100MΩ
操作温度范围 Operating Temperature	-55~+170°C	-55~+170°C
阻值精度范围 F(±1%)、G(±2%)、 J(±5%) Resistance Range	2mΩ~30mΩ	1mΩ~100mΩ

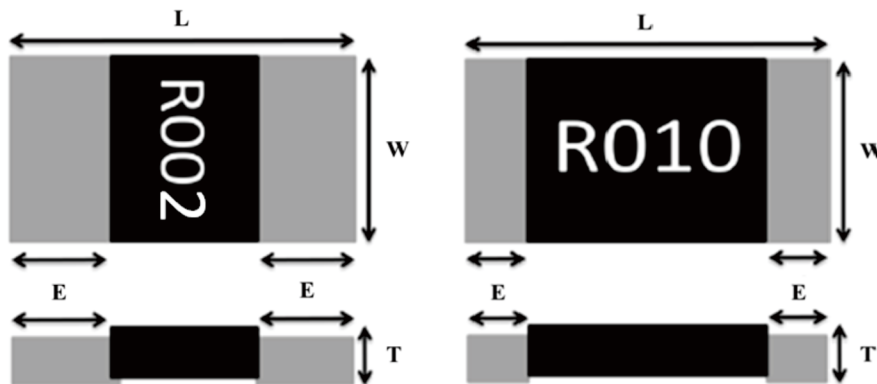
外形尺寸 Dimension

类型 Type		AM1206	AM2512
尺寸 Dimension	L(mm)	3.20±0.20	6.40±0.20
	W(mm)	1.60±0.20	3.20±0.20
	T(mm)	0.60±0.20	0.60±0.20
	E(mm)	0.50±0.30	2.00±0.20 (R≤2mΩ) 0.90±0.20 (R≥3mΩ)

性能 Performance Specifications

内容 Item	测试方法 Test Methods	规格 Specification Limits
温度系数 Temperature Coefficient	IEC60115-1 4.8	参照规格表 As Spec.
高温储存 High Temperature Exposure(Storage)	MIL-STD-202 Method 108	<±1%
低温储存 Low Temperature operation	IEC60115-1 4.23.4	<±1%
温度循环 Temperature Cycling	JESD22 Method JA-104	<±1%
短时间过负荷 Short-Time Overload	IEC60115-1 4.13	<±1%
耐湿特性 Humidity	MIL-STD-202 METHOD 103	<±1%
负荷寿命 Load Life	MIL-STD-202 METHOD 108	<±1%
焊锡性 Solderability	J-STD-002B test B	最少95%面积上锡 Min 95% coverage
抗焊锡热 Resist to Soldering Heat	IEC60115-1 4.18	<±1%
机械冲击 Mechanical Shock	MIL-STD-202 METHOD 213	<±1%
抗振动性 Resistance to vibration	MIL-STD-202 METHOD 204	<±1%
端子弯曲 Terminal Bending	AEC-Q200-005	<±1%
端子强度 Terminal Strength	AEC-Q200-006	<±1%
冷热冲击 Thermal shock	MIL-STD-202 METHOD 107	<±1%
阻燃性 Flammability	UL-94	/
ESD试验 ESD test	AEC-Q200-002	<±1%

特性 Features

阻值最低到0.2mΩ，尺寸最大到5930 Min. Resistance value to 0.2mΩ and max. Size to 5930

额定功率最大到7W Power rating max. to 7 w.

超低阻值，适用于检测大电流 Ultra low resistance, suitable for large current sensing.

产品符合RoHS与无卤要求 Products meet RoHS compliant & Free requirements

符合AEC-Q200相关条款 AEC-Q200 qualified

应用 Application

车载模块检测 Current Sensing for module of automobiles.

变频器 Frequency converters

通信系统 Communication system

混合应用的电源电流传感器 Current sensor for power hybrid applications

功率衰减曲线 Power Derating Curve

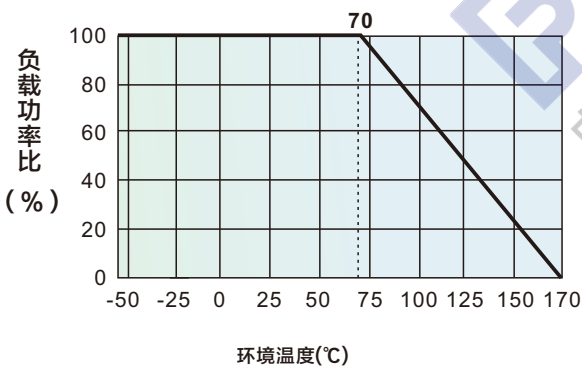

分流器本体字码标示(Marking on the Shunt Resistor's Body):

※ ±1%, ±2%, ±5%的产品，以四字码标示，第一位字码“R”标示10⁻³，后三位表示阻值的有效数字。第二位字码“m”表示阻值小数点。

±1%, ±2%, ±5% tolerance product: the marking is 4 digits, The first letter 'R' denotes 10⁻³, The other three digitals declare resistance. The second letter 'm' mean point.

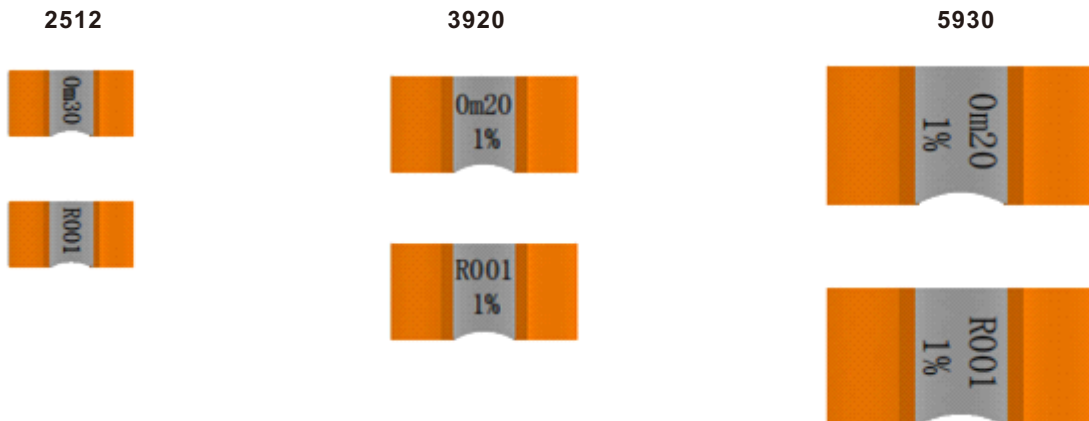

订货方式 (例如3920 5W 1% 1mΩ)

Ordering Procedure (Example 3920 5W 1% 1mΩ)

料号 (Part Number) : RZ3920FRR001G

RZ	3920	F	R	R001	G
类型 (Type) RZ:低阻分流器贴片电阻 (Low-Resistance Shunt chip resistors)	尺寸 (Size) 2512 3920 5930	公差 Tolerance F=±1% G=±2% J=±5%	额定功率 Rated Power C= 3W R=5W S=7W	阻值 Resistance Value R001=1mΩ 0L50=0.5mΩ	包装代码 Packing Code G=Reel(卷装) V=Bulk (散料) S=Double Standard Quantity (两倍卷盘标准包装量)

特性 Characteristics

类型 Type	RZ2512		RZ3920		RZ5930	
额定功率 70°C Rated Power at 70°C	3W		5W		7W	
温度特性TCR (ppm/°C)	±150	±75	±150	±75	±150	±75
绝缘阻抗 Insulation Resistance	>100MΩ	>100MΩ	>100MΩ	>100MΩ	>100MΩ	>100MΩ
操作温度范围 Operating Temperature	-55~+170°C	-55~+170°C	-55~+170°C	-55~+170°C	-55~+170°C	-55~+170°C
阻值精度范围(mΩ) F(±1%)、G(±2%)、J(±5%) Resistance Range(mΩ)	0.3、0.35、0.4、 0.5、0.7、1	2	0.2、0.3、0.5、 0.7	1、2、3、4、5	0.2、0.3、0.4、 0.5、0.75、0.8	1、2、3

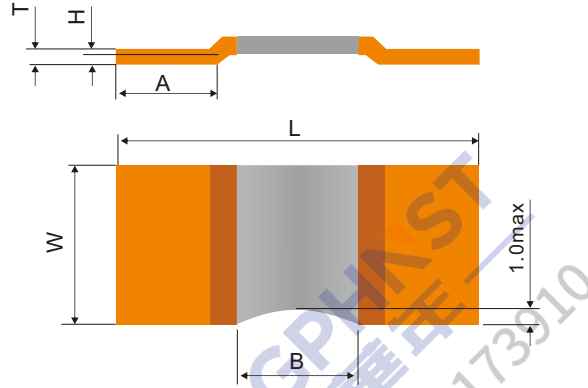
外形尺寸 Dimension

备注: 侧边圆弧为调阻缺口
Note: The circular arc is trimmer gap

类型 Type	阻值(mΩ) Resistance	B(mm)	W(mm)	L(mm)	A(mm)	H(mm)	T(mm)
RZ2512	0.3	3.0±0.3	3.2±0.25	6.4±0.2	1.2±0.2	0.5±0.1	0.95±0.1
	0.35						0.60±0.1
	0.4						0.88±0.1
	0.5						0.85±0.1
	0.7						0.60±0.1
	1						0.42±0.1
	2						0.67±0.1
RZ3920	0.2	4.5±0.3	5.2±0.3	10±0.2	2.0±0.2	0.5±0.1	1.66±0.1
	0.3						1.28±0.1
	0.5						0.77±0.1
	0.7						0.55±0.1
	1						1.25±0.1
	2						0.62±0.1
	3						0.42±0.1
	4						0.35±0.1
	5						0.28±0.1
RZ5930	0.2	5.0±0.3	7.7±0.3	15±0.2	4.2±0.2	0.5±0.1	1.50±0.1
	0.3						0.96±0.1
	0.4						0.72±0.1
	0.5						0.58±0.1
	0.75						0.39±0.1
	0.8						0.36±0.1
	1						0.94±0.1
	2						0.48±0.1
	3						0.31±0.1

性能 Performance Specifications

内容 Item	测试方法 Test Methods	规格 Specification Limits
温度系数 Temperature Coefficient	IEC60115-1 4.8	参照规格表 As Spec.
高温储存 High Temperature Exposure(Storage)	MIL-STD-202 Method 108	<±1%
低温储存 Low Temperature operation	IEC60115-1 4.23.4	<±1%
温度循环 Temperature Cycling	JESD22 Method JA-104	<±1%
短时间过负荷 Short-Time Overload	IEC60115-1 4.13	<±1%
耐湿特性 Humidity	MIL-STD-202 METHOD 103	<±1%
负荷寿命 Load Life	MIL-STD-202 METHOD 108	<±1%
焊锡性 Solderability	J-STD-002B test B	最少95%面积上锡 Min 95% coverage
抗焊锡热 Resist to Soldering Heat	IEC60115-1 4.18	<±1%
机械冲击 Mechanical Shock	MIL-STD-202 METHOD 213	<±1%
抗振动性 Resistance to vibration	MIL-STD-202 METHOD 204	<±1%
端子弯曲 Terminal Bending	AEC-Q200-005	<±1%
端子强度 Terminal Strength	AEC-Q200-006	<±1%
冷热冲击 Thermal shock	MIL-STD-202 METHOD 107	<±1%
ESD试验 ESD test	AEC-Q200-002	<±1%

特性 Features

最大使用功率 3W Max power rating to 3watt
 超低电阻温度系数 Low TCR
 超低热电动势能 Low EMF.
 良好散热效果 Good heat dissipation.
 符合AEC-Q200产品认证 AECQ200 qualification*

应用 Application

电源供应器 Power Supply
 电池管理系统 BMS
 变频器 Converter
 电信设备 Telecommunications equipment
 电源供应器 Power supply
 汽车电子 Automotive electronics

构造 Construction

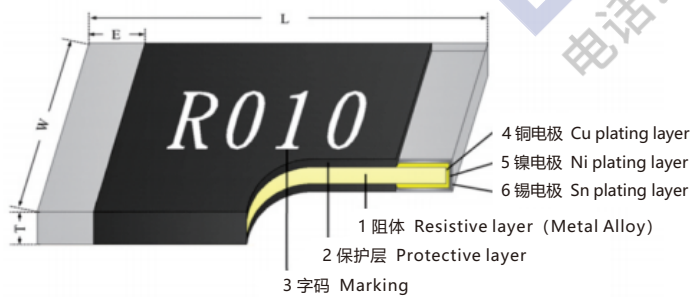

功率衰减曲线 Power Derating Curve

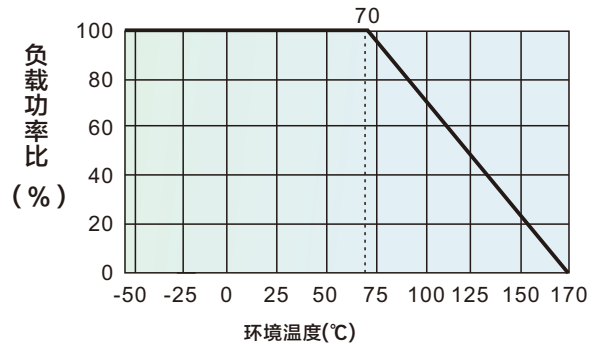

订货方式 (例如2512 3W 1% 10mΩ)

Ordering Procedure (Example 2512 3W 1% 10mΩ)

料号 (Part Number) : RM2512FCR010GM

RM	2512	F	C	R010	G	M
<p>类型 (Type)</p> <p>RM: RM 3W高功率合金贴片电阻 (High Power Metal Current Sensing Chip Resistors for RM 3W)</p>	<p>尺寸 (Size)</p> <p>2512</p>	<p>公差 Tolerance</p> <p>F=±1% G=±2% J=±5%</p>	<p>额定功率 Rated Power</p> <p>C= 3W</p>	<p>阻值 Resistance Value</p> <p>R002=2mΩ R010=10 mΩ 2L50=2.5mΩ</p>	<p>包装代码 Packing Code</p> <p>G=Reel(卷装) V=Bulk (散料) S=Double Standard Quantity (两倍卷盘标准包装量)</p>	<p>材料 Material</p> <p>M=MnCu N=NiCu S=CuMnSn</p>

特性 Characteristics

类型 Type	RM2512
额定功率 70°C Rated Power at 70°C	3W
温度特性TCR (ppm/°C)	+25°C~+125°C:±50
	+25°C~+155°C:±65
绝缘耐压 Dielectric Withstanding Voltage	>100MΩ
操作温度范围 Operating Temperature	-55~+170°C
阻值精度范围 F(±1%)、G(±2%)、J(±5%) Resistance Range	1mΩ~10mΩ

外形尺寸 Dimension

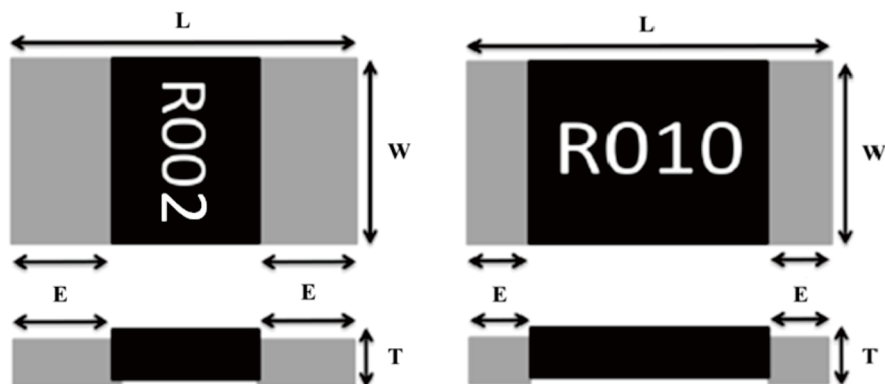

类型 Type		RM2512
尺寸 Dimension	L(mm)	6.40±0.20
	W(mm)	3.20±0.20
	T(mm)	0.60±0.20
	E(mm)	2.00±0.20(R≤2mΩ)
		0.90±0.20(R≥3mΩ)

性能 Performance Specifications

内容 Item	测试方法 Test Methods	规格 Specification Limits
温度系数 Temperature Coefficient	IEC60115-1 4.8	参照规格表 As Spec.
高温储存 High Temperature Exposure(Storage)	MIL-STD-202 Method 108	<±1%
低温储存 Low Temperature operation	IEC60115-1 4.23.4	<±1%
温度循环 Temperature Cycling	JESD22 Method JA-104	<±1%
短时间过负荷 Short-Time Overload	IEC60115-1 4.13	<±1%
耐湿特性 Humidity	MIL-STD-202 METHOD 103	<±1%
负荷寿命 Load Life	MIL-STD-202 METHOD 108	<±2%
焊锡性 Solderability	J-STD-002B test B	最少95%面积上锡 Min 95% coverage
抗焊锡热 Resist to Soldering Heat	IEC60115-1 4.18	<±0.5%
机械冲击 Mechanical Shock	MIL-STD-202 METHOD 213	<±0.5%
抗振动性 Resistance to vibration	MIL-STD-202 METHOD 204	<±0.5%
端子弯曲 Terminal Bending	AEC-Q200-005	<±0.5%
端子强度 Terminal Strength	AEC-Q200-006	<±1%
冷热冲击 Thermal shock	MIL-STD-202 METHOD 107	<±1%
阻燃性 Flammability	UL-94	/
ESD试验 ESD test	AEC-Q200-002	<±1%

特性 Features

- 铅含量 < 100ppm
- 适合贴片机组装 Suitable for SMT
- 短小轻薄 Small Size & Light Weight
- 符合RoHS和无卤标准 Meet RoHS & HF Requirement

应用 Application

- 一般用途 General Purpose
- 通用型 Universal type

构造 Construction

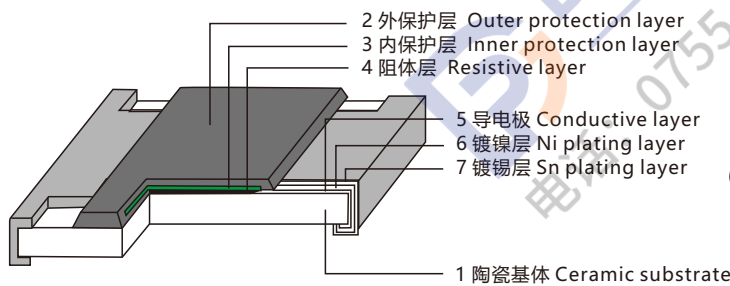

功率衰减曲线 Power Derating Curve

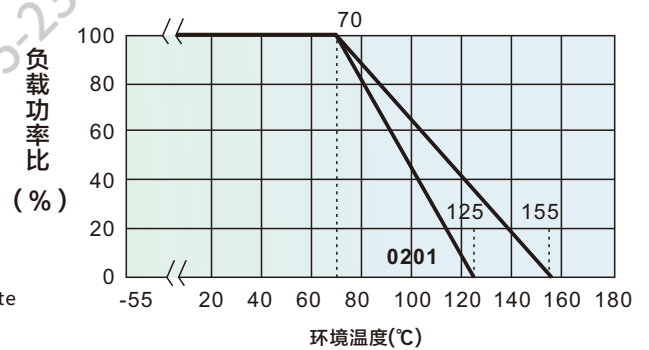

订货方式 (例如:0603 5% 1/10W 100Ω)

Ordering Procedure (Example: 0603 1/10W 5% 100Ω)

料号 (Part Number) : PF0603JA0101G

PF	0603	J	A	0101	G
类型 (Type) PF:无铅厚膜贴片电阻 (Total Lead Free Thick Film Chip Resistors)	尺寸 (Size) 0201 0402 0603 0805 1206 1210 2010 2512	公差 Tolerance B=±0.1% D=±0.5% F=±1% G=±2% J=±5%	额定功率 Rated Power 1=1W 2=3/4W 3=1/2W 4=1/4W 8=1/8W A=1/10W F=1/16W H=1/20W	阻值 Resistance Value ±1%, ±0.5%, ±0.1% 49R9=49.9Ω 1002=10KΩ ±2%, ±5%: 06R8=6.8Ω 0564=560KΩ	包装代码 Packing Code G=Reel(卷装) V=Bulk (散料) S=Double Standard Quantity (两倍卷盘标准包装量)

特性 Characteristics

类型 Type	PF0201	PF0402	PF0603	PF0805	PF1206	PF1210	PF2010	PF2512
额定功率 70°C Rated Power at 70°C	1/20W	1/16W	1/10W	1/8W	1/4W	1/2W	3/4W	1W
最大工作电压 Max Working Voltage	25V	50V	75V	150V	200V	200V	200V	200V
最大过负荷电压 Max Overload Voltage	50V	100V	150V	300V	400V	500V	500V	500V
绝缘耐压 WithStanding Voltage Dielectric	75V	150V	220V	430V	570V	710V	710V	710V
操作温度范围 Operating Temperature	-55 ~ +125°C	-55 ~ +155°C	-55 ~ +155°C	-55 ~ +155°C	-55 ~ +155°C	-55 ~ +155°C	-55 ~ +155°C	-55 ~ +155°C
零欧姆电阻阻值 Resistance Value of Jumper	< 50mΩ	< 50mΩ	< 50mΩ	< 50mΩ	< 50mΩ	< 50mΩ	< 50mΩ	< 50mΩ
零欧姆额定电流 Rated Current of Jumper	0.5A	1.0A	1.0A	2.0A	2.0A	2.0A	2.0A	2.0A
零欧姆最大电流 Max Current of jumper	1.0A	2.0A	2.0A	5.0A	10.0A	10.0A	10.0A	10.0A
0.1%阻值范围 Resistance Range of 0.1%	100Ω-1MΩ	100Ω-1MΩ	100Ω-1MΩ	100Ω-1MΩ	100Ω-1MΩ	100Ω-1MΩ	100Ω-1MΩ	100Ω-1MΩ
0.5%阻值范围 Resistance Range of 0.5%	10Ω-1MΩ	10Ω-1MΩ	10Ω-1MΩ	10Ω-1MΩ	10Ω-1MΩ	10Ω-1MΩ	1Ω-1MΩ	10Ω-1MΩ
1%阻值范围 Resistance Range of 1%	1Ω-10MΩ	1Ω-22MΩ	1Ω-22MΩ	1Ω-22MΩ	1Ω-22MΩ	1Ω-22MΩ	1Ω-22MΩ	1Ω-22MΩ
2%阻值范围 Resistance Range of 2%	1Ω-10MΩ	1Ω-22MΩ	1Ω-22MΩ	1Ω-22MΩ	1Ω-22MΩ	1Ω-22MΩ	1Ω-22MΩ	1Ω-22MΩ
5%阻值范围 Resistance Range of 5%	1Ω-10MΩ	1Ω-22MΩ	1Ω-22MΩ	1Ω-22MΩ	1Ω-22MΩ	1Ω-22MΩ	1Ω-22MΩ	1Ω-22MΩ

外形尺寸 Dimension

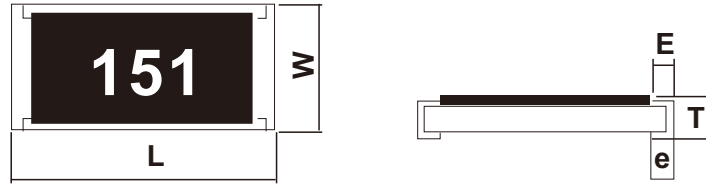

类型 Type	PF0402	PF0402	PF0603	PF0805	PF1206	PF1210	PF2010	PF2512	
尺寸 Dimension	L(mm)	0.60±0.03	1.00±0.05	1.60±0.10	2.00±0.15	3.10±0.15	3.10±0.15	5.00±0.20	6.25±0.20
	W(mm)	0.30±0.03	0.50±0.05	0.80±0.10	1.25±0.15	1.60±0.15	2.50±0.15	2.50±0.20	3.10±0.20
	T(mm)	0.23±0.03	0.30±0.05	0.45±0.10	0.50±0.10	0.55±0.10	0.55±0.15	0.55±0.15	0.55±0.15
	E(mm)	0.10±0.05	0.15±0.10	0.25±0.20	0.35±0.20	0.45±0.25	0.35±0.25	0.65±0.25	0.85±0.25
	e(mm)	0.15±0.05	0.20±0.10	0.30±0.20	0.40±0.20	0.40±0.25	0.60±0.25	0.50±0.25	0.95±0.25

性能 Performance Specifications

内容 Item	测试方法 Test Methods	规格 Specification Limits
温度系数 Temperature Coefficient	JIS C5201 4.8	0201规格: 1Ω ≤ R ≤ 10Ω: -100 ~ +300 PPM/°C 10Ω < R ≤ 10MΩ: ±200 PPM/°C 0402 ~ 2512规格: 1Ω ≤ R ≤ 10Ω: ±200 PPM/°C 10Ω < R ≤ 10MΩ: ±100 PPM/°C 10MΩ < R ≤ 22MΩ: ±200 PPM/°C
焊锡性 Solderability	JIS C5201 4.17	最少95%面积上锡 Min 95% coverage
绝缘电阻 Insulation Resistance	JIS C5201 4.6	> 10GΩ
绝缘耐压 Dielectric Withstanding Voltage	JIS C5201 4.7	无击穿、飞弧及可见机械性损伤 No evidence of flashover, mechanical damage arcing or insulation breakdown
短时间过负荷 Short-Time Overload	JIS C5201 4.13	±(1.0%+0.05Ω)Max(最大)
端子弯曲 Terminal Bending	JIS C5201 4.33	±(1.0%+0.05Ω)Max(最大)
抗焊锡热 Resist to Soldering Heat	JIS C5201 4.18	±(1.0%+0.05Ω)Max(最大)
负荷寿命 Load Life	JIS C5201 4.25.1	±(2.0%+0.05Ω)Max(最大)
耐湿特性 Humidity	JIS C5201 4.24	±(2.0%+0.05Ω)Max(最大)
温度循环 Temperature Cycling	JIS C5201 4.19	±(2.0%+0.05Ω)Max(最大)
温湿循环 Moisture Resistance	MIL-STD-202 METHOD106	±(2.0%+0.05Ω)Max(最大)

特性 Features

适合贴片机组装 Suitable for SMT
符合RoHS和无卤标准 Meet RoHS & HF Requirement
高电压High Voltage

应用 Application

相机闪光灯电路 Camera Flash Circuit
打印设备 Printing equipment
电源电路 Power Circuit

构造 Construction

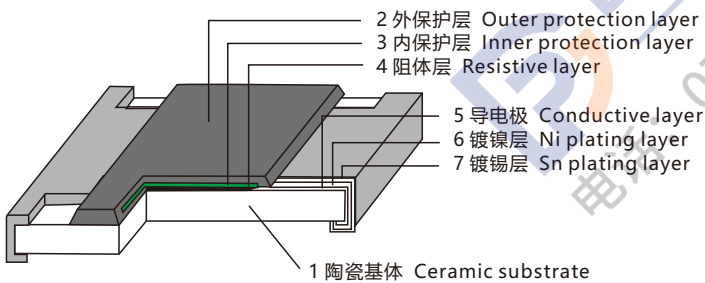

功率衰减曲线 Power Derating Curve

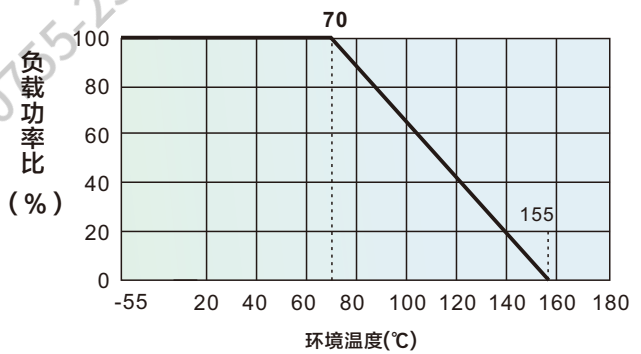

订货方式 (例如0603 1% 1/10W 47Ω)

Ordering Procedure (Example 0603 1% 1/10W 47Ω)

料号 (Part Number) : RC0603FA47R0G

RC	0603	F	A	47R0	G
类型 (Type) RC:高压厚膜贴片电阻(High voltage thick film chip resistors)	尺寸 (Size) 0603 0805 1206 1210 2010 2512	公差 Tolerance D=±0.5% F=±1% G=±2% J=±5%	额定功率 Rated Power 1= 1W 2=3/4W 3=1/2W 4= 1/4W 8= 1/8W A= 1/10W	阻值 Resistance Value ±1%: 47R0=47Ω 1002=10KΩ ±2%, ±5%: 0470=47Ω 0564=560KΩ	包装代码 Packing Code G= reel (卷装) V= bulk (散料) S= Double Standard Quantity (两倍卷盘标准包装量)

特性 Characteristics

类型 Type	RC0603	RC0805	RC1206	RC1210	RC2010	RC2512
额定功率 70°C Rated Power at 70°C	1/10W	1/8W	1/4W	1/2W	3/4W	1W
最大工作电压 Max Working Voltage	350V	400V	500V	500V	500V	500V
最大过负荷电压 Max Overload Voltage	500V	800V	1000V	1000V	1000V	1000V
绝缘耐压 WithStanding Voltage Dielectric	500V	800V	1000V	1000V	1000V	1000V
操作温度范围 Operating Temperature	-55~+155°C	-55~+155°C	-55~+155°C	-55~+155°C	-55~+155°C	-55~+155°C
0.5%阻值范围 Resistance Range of 0.5%	10Ω-1MΩ	10Ω-1MΩ	10Ω-1MΩ	10Ω-1MΩ	10Ω-1MΩ	10Ω-1MΩ
1%阻值范围 Resistance Range of 1%	1Ω-100MΩ	1Ω-100MΩ	1Ω-100MΩ	1Ω-100MΩ	1Ω-100MΩ	1Ω-100MΩ
2%阻值范围 Resistance Range of 2%	1Ω-100MΩ	1Ω-100MΩ	1Ω-100MΩ	1Ω-100MΩ	1Ω-100MΩ	1Ω-100MΩ
5%阻值范围 Resistance Range of 5%	1Ω-100MΩ	1Ω-100MΩ	1Ω-100MΩ	1Ω-100MΩ	1Ω-100MΩ	1Ω-100MΩ

外形尺寸 Dimension

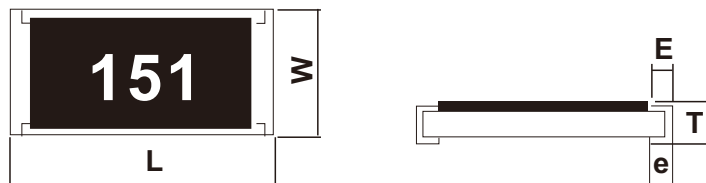

类型 Type		RC0603	RC0805	RC1206	RC1210	RC2010	RC2512
尺寸 Dimension	L(mm)	1.60±0.10	2.00±0.15	3.10±0.15	3.10±0.15	5.00±0.20	6.25±0.20
	W(mm)	0.80±0.10	1.25±0.15	1.60±0.15	2.50±0.15	2.50±0.20	3.10±0.20
	T(mm)	0.45±0.10	0.50±0.10	0.55±0.10	0.55±0.15	0.55±0.15	0.55±0.15
	E(mm)	0.25±0.20	0.35±0.20	0.45±0.25	0.35±0.25	0.65±0.25	0.85±0.25
	e(mm)	0.30±0.20	0.40±0.20	0.40±0.25	0.60±0.25	0.50±0.25	0.95±0.25

性能 Performance Specifications

内容 Item	测试方法 Test Methods	规格 Specification Limits
温度系数 Temperature Coefficient	JIS C5201 4.8	$1\Omega \leq R \leq 10\Omega$: ± 200 PPM/ $^{\circ}\text{C}$ $10\Omega < R \leq 10\text{M}\Omega$: ± 100 PPM/ $^{\circ}\text{C}$ $10\text{M}\Omega < R \leq 100\text{M}\Omega$: ± 200 PPM/ $^{\circ}\text{C}$
焊锡性 Solderability	JIS C5201 4.17	最少95%面积上锡 Min 95% coverage
绝缘电阻 Insulation Resistance	JIS C5201 4.6	$> 10\text{G}\Omega$
绝缘耐压 Dielectric Withstanding Voltage	JIS C5201 4.7	无击穿、飞弧及可见机械性损伤 No evidence of flashover, mechanical damage arcing or insulation breakdown
短时间过负荷 Short-Time Overload	JIS C5201 4.13	$\pm(1.0\% + 0.05\Omega)$ Max(最大)
端子弯曲 Terminal Bending	JIS C5201 4.33	$\pm(1.0\% + 0.05\Omega)$ Max(最大)
抗焊锡热 Resist to Soldering Heat	JIS C5201 4.18	$\pm(1.0\% + 0.05\Omega)$ Max(最大)
负荷寿命 Load Life	JIS C5201 4.25.1	$\pm(2.0\% + 0.05\Omega)$ Max(最大)
耐湿特性 Humidity	JIS C5201 4.24	$\pm(2.0\% + 0.05\Omega)$ Max(最大)
温度循环 Temperature Cycling	JIS C5201 4.19	$\pm(2.0\% + 0.05\Omega)$ Max(最大)
温湿循环 Moisture Resistance	MIL-STD-202 METHOD106	$\pm(2.0\% + 0.05\Omega)$ Max(最大)
高温储存 High Temperature Exposure(Storage)	MIL-STD-202 METHOD 108	$\pm(1.0\% + 0.05\Omega)$ Max(最大)

特性 Features

适合贴片机组装 Suitable for SMT
 符合RoHS和无卤标准 Meet RoHS & HF Requirement
 抗浪涌电压 Anti-Surge Voltage

应用 Application

显示器, 电源, 电脑, 数码相机, 开关
 Monitor, Power, Computer, Digital camera, Switch
 医疗设备, 军事装备, 自动化设备, 电信设备
 Medical equipment, Military equipment, Automation equipment, Telecommunications equipment

构造 Construction

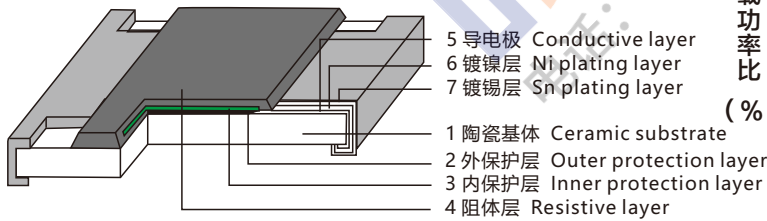

功率衰减曲线 Power Derating Curve

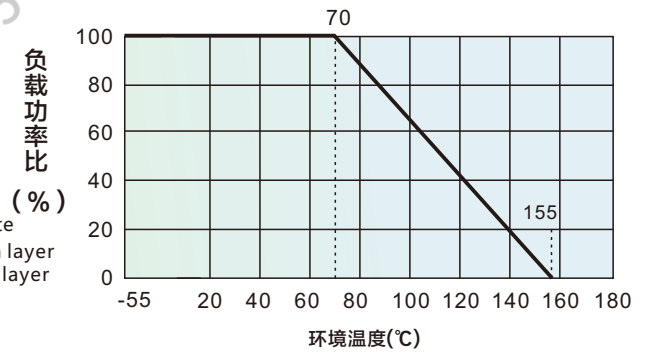

脉冲功率曲线 Curve of Pulse Duration

公差Tolerance:
 ±1.00%、±2.00%如下:

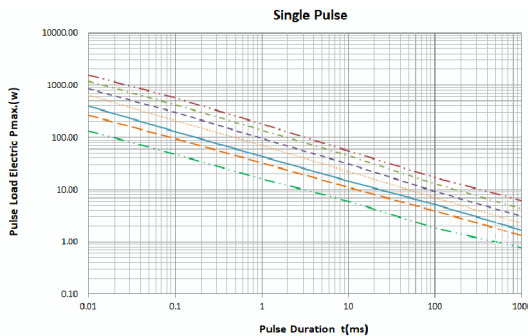

公差Tolerance:
 ±5.00%、±10.00%、±15.00%、±20.00%如下:

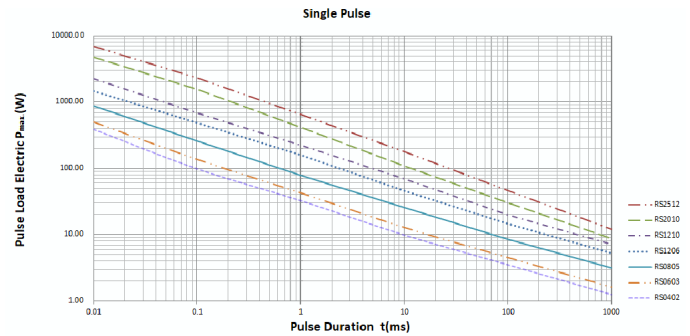

订货方式 (例如0603 1% 1/10W 47Ω)

Ordering Procedure (Example 0603 1% 1/10W 47Ω)

料号 (Part Number) : RS0603FA47R0G

RS	0603	F	A	47R0	G
类型 (Type) RS:抗浪涌厚膜贴片电阻(Anti-surge thick film chip resistors)	尺寸 (Size) 0402 0603 0805 1206 1210 2010 2512	公差 Tolerance F=±1% G=±2% J=±5% K=±10% L=±15% M=±20%	额定功率 Rated Power 1= 1W 2=3/4W 3=1/2W 4= 1/4W 8= 1/8W A= 1/10W F= 1/16W	阻值 Resistance Value ±1%: 49R9=49.9Ω 1002=10KΩ ±2%, ±5%, ±10%, ±15%, ±20%: 06R8=6.8Ω 0564=560KΩ	包装代码 Packing Code G=Reel(卷装) V=Bulk (散料) S=Double Standard Quantity (两倍卷盘标准包装量)

特性 Characteristics

类型 Type	RS0402	RS0603	RS0805	RS1206	RS1210	RS2010	RS2512
额定功率 70°C Rated Power at 70°C	1/10W	1/8W	1/4W	1/2W	3/4W	3/4W	1W
最大工作电压 Max Working Voltage	50V	75V	150V	200V	200V	200V	200V
最大过负荷电压 Max Overload Voltage	100V	150V	300V	400V	500V	500V	500V
绝缘耐压 With Standing Voltage Dielectric	150V	220V	430V	570V	710V	710V	710V
操作温度范围 Operating Temperature	-55~+155°C	-55~+155°C	-55~+155°C	-55~+155°C	-55~+155°C	-55~+155°C	-55~+155°C
1%阻值范围 Resistance Range of 1%	1Ω-22MΩ	1Ω-22MΩ	1Ω-22MΩ	1Ω-22MΩ	1Ω-22MΩ	1Ω-22MΩ	1Ω-22MΩ
2%阻值范围 Resistance Range of 2%	1Ω-22MΩ	1Ω-22MΩ	1Ω-22MΩ	1Ω-22MΩ	1Ω-22MΩ	1Ω-22MΩ	1Ω-22MΩ

特性 Characteristics

类型 Type	RS0402	RS0603	RS0805	RS1206	RS1210	RS2010	RS2512
5%阻值范围 Resistance Range of 5%	1Ω-22MΩ	1Ω-22MΩ	1Ω-22MΩ	1Ω-22MΩ	1Ω-22MΩ	1Ω-22MΩ	1Ω-22MΩ
10%阻值范围 Resistance Range of 10%	1Ω-22MΩ	1Ω-22MΩ	1Ω-22MΩ	1Ω-22MΩ	1Ω-22MΩ	1Ω-22MΩ	1Ω-22MΩ
15%阻值范围 Resistance Range of 15%	1Ω-22MΩ	1Ω-22MΩ	1Ω-22MΩ	1Ω-22MΩ	1Ω-22MΩ	1Ω-22MΩ	1Ω-22MΩ
20%阻值范围 Resistance Range of 20%	1Ω-22MΩ	1Ω-22MΩ	1Ω-22MΩ	1Ω-22MΩ	1Ω-22MΩ	1Ω-22MΩ	1Ω-22MΩ

外形尺寸 Dimension

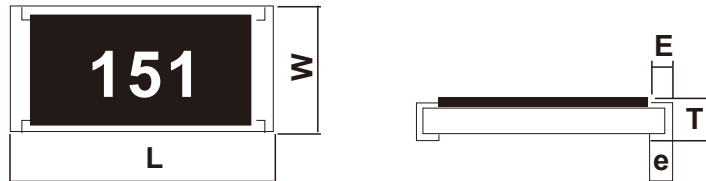

类型 Type	RS0402	RS0603	RS0805	RS1206	RS1210	RS2010	RS2512	
尺寸 Dimension	L(mm)	1.00±0.05	1.60±0.10	2.00±0.15	3.10±0.15	3.10±0.15	5.00±0.20	6.25±0.20
	W(mm)	0.50±0.05	0.80±0.10	1.25±0.15	1.60±0.15	2.50±0.15	2.50±0.20	3.10±0.20
	T(mm)	0.30±0.05	0.45±0.10	0.50±0.10	0.55±0.10	0.55±0.15	0.55±0.15	0.55±0.15
	E(mm)	0.15±0.10	0.25±0.20	0.35±0.20	0.45±0.25	0.35±0.25	0.65±0.25	0.85±0.25
	e(mm)	0.20±0.10	0.30±0.20	0.40±0.20	0.40±0.25	0.60±0.25	0.50±0.25	0.95±0.25

性能 Performance Specifications

内容 Item	测试方法 Test Methods	规格 Specification Limits
温度系数 Temperature Coefficient	JIS C5201 4.8	1Ω ≤ R ≤ 10Ω: ±200 PPM/°C 10Ω < R ≤ 10MΩ: ±100 PPM/°C 10MΩ < R ≤ 100MΩ: ±200PPM/°C
焊锡性 Solderability	JIS C5201 4.17	最少95%面积上锡 Min 95% coverage
绝缘电阻 Insulation Resistance	JIS C5201 4.6	> 10GΩ
绝缘耐压 Dielectric Withstanding Voltage	JIS C5201 4.7	无击穿、飞弧及可见机械性损伤 No evidence of flashover, mechanical damage arcing or insulation breakdown
短时间过负荷 Short-Time Overload	JIS C5201 4.13	±(1.0%+0.05Ω)Max(最大)
端子弯曲 Terminal Bending	JIS C5201 4.33	±(1.0%+0.05Ω)Max(最大)
抗焊锡热 Resist to Soldering Heat	JIS C5201 4.18	±(1.0%+0.05Ω)Max(最大)
负荷寿命 Load Life	JIS C5201 4.25.1	±(2.0%+0.05Ω)Max(最大)
耐湿特性 Humidity	JIS C5201 4.24	±(2.0%+0.05Ω)Max(最大)
温度循环 Temperature Cycling	JIS C5201 4.19	±(2.0%+0.05Ω)Max(最大)
温湿循环 Moisture Resistance	MIL-STD-202 METHOD106	±(2.0%+0.05Ω)Max(最大)
高温储存 High Temperature Exposure(Storage)	MIL-STD-202 METHOD 108	±(1.0%+0.05Ω)Max(最大)
脉冲 Pulse	IEC 60115-1 4.27	±(2.0%+0.05Ω)Max(最大)

特性 Features

适合贴片机组装 Suitable for SMT
符合RoHS和无卤标准 Meet RoHS & HF Requirement
宽电极Wide Terminal

应用 Application

电源供应器 Power supply
开关电源 Switching power supply
电压调节器 Voltage regulator

构造 Construction

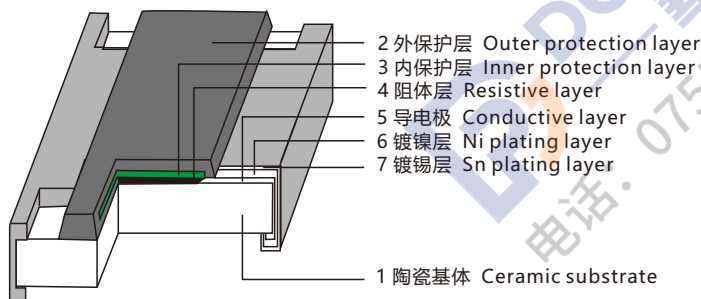

功率衰减曲线 Power Derating Curve

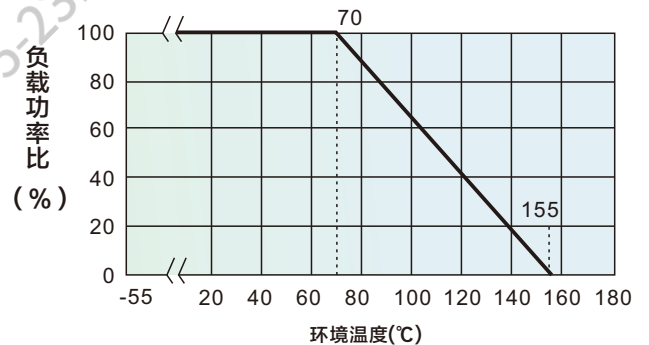

订货方式 (例如1225 1% 2W 20Ω)

Ordering Procedure (Example 1225 1% 2W 20Ω)

料号 (Part Number) : RW1225FB20R0G

RW	1225	F	B	20R0	G
类型 (Type) RW: 宽电极厚膜贴片电阻 (Wide Terminal thick film chip resistors)	尺寸 (Size) 0612 1020 1225	公差 Tolerance F= ±1% J= ±5%	额定功率 Rated Power 1= 1W 2= 3/4W B= 2W	阻值 Resistance Value ±1%: 20R0=20Ω 49R9=49.9Ω 1002=10KΩ ±5%: 06R8=6.8Ω 0200=20Ω 0564=560KΩ	包装代码 Packing Code G= reel (卷装) V= bulk (散料) S= Double Standard Quantity (两倍卷盘标准包装量)

标准包装数量 Standard Packing Quantity

0612: 5,000Pcs Per Reel(每卷5,000Pcs)

1020/1225: 4,000Pcs Per Reel(每卷4,000Pcs)

特性 Characteristics

类型 Type	RW0612	RW1020	RW1225
额定功率 70°C Rated Power at 70°C	3/4W	1W	2W
最大工作电压 Max Working Voltage	200V	200V	200V
最大过负荷电压 Max Overload Voltage	400V	400V	400V
绝缘耐压 Dielectric Withstanding Voltage	570V	710V	710V
操作温度范围 Operating Temperature	-55~+155°C	-55~+155°C	-55~+155°C
零欧姆阻值 Resistance Value of Jumper	<50mΩ	<50mΩ	<50mΩ
零欧姆额定电流 Rated Current of Jumper	2.0A	2.0A	2.0A
零欧姆电阻最大电流 Max Current of Jumper	10.0A	10.0A	10.0A
1%阻值范围 Resistance Range of 1%	1Ω-1MΩ	1Ω-1MΩ	1Ω-1MΩ
5%阻值范围 Resistance Range of 5%	1Ω-1MΩ	1Ω-1MΩ	1Ω-1MΩ

外形尺寸 Dimension

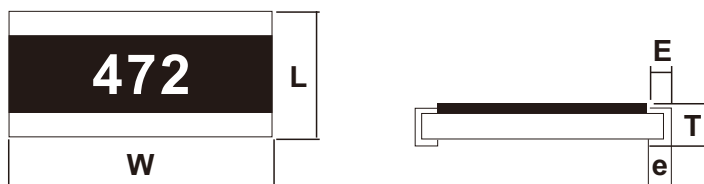

类型 Type		RW0612	RW1020	RW1225
尺寸 Dimension	L(mm)	1.60±0.15	2.50±0.15	3.10±0.15
	W(mm)	3.20±0.20	5.00±0.15	6.30±0.15
	T(mm)	0.60±0.10	0.60±0.10	0.60±0.10
	E(mm)	0.30±0.20	0.40±0.20	0.45±0.20
	e(mm)	0.45±0.15	0.75±0.15	0.75±0.15

性能 Performance Specifications

内容 Item	测试方法 Test Methods	规格 Specification Limits
温度系数 Temperature Coefficient	JIS C5201 4.8	$1\Omega \leq R \leq 10\Omega$: ± 200 PPM/ $^{\circ}\text{C}$ $10\Omega < R \leq 1\text{M}\Omega$: ± 100 PPM/ $^{\circ}\text{C}$
焊锡性 Solderability	JIS C5201 4.17	最少95%面积上锡 Min 95% coverage
绝缘电阻 Insulation Resistance	JIS C5201 4.6	$> 10\text{G}\Omega$
绝缘耐压 Dielectric Withstanding Voltage	JIS C5201 4.7	无击穿、飞弧及可见机械性损伤 No evidence of flashover, mechanical damage arcing or insulation breakdown
短时间过负荷 Short-Time Overload	JIS C5201 4.13	$\pm(1.0\% + 0.0.05\Omega)\text{Max(最大)}$
端子弯曲 Terminal Bending	JIS C5201 4.33	$\pm(1.0\% + 0.0.05\Omega)\text{Max(最大)}$
抗焊锡热 Resist to Soldering Heat	JIS C5201 4.18	$\pm(1.0\% + 0.05\Omega)\text{Max(最大)}$
负荷寿命 Load Life	JIS C5201 4.25.1	$\pm(2.0\% + 0.05\Omega)\text{Max(最大)}$
耐湿特性 Humidity	JIS C5201 4.24	$\pm(2.0\% + 0.05\Omega)\text{Max(最大)}$
温度循环 Temperature Cycling	JIS C5201 4.19	$\pm(2.0\% + 0.05\Omega)\text{Max(最大)}$
温湿循环 Moisture Resistance	MIL-STD-202 METHOD106	$\pm(2.0\% + 0.05\Omega)\text{Max(最大)}$

特性 Features

- 适合贴片机组装 Suitable for SMT
- 符合RoHS和无卤标准 Meet RoHS & HF Requirement
- 宽电极Wide Terminal
- 符合AEC-Q200标准 Comply with AEC-Q200 standard
- 优越的抗硫化特性 Superior resistance against sulfur containing atmosphere

应用 Application

- 汽车电子 Automotive electronics
- 电信设备 Telecommunications equipment
- 电源电压控制 Voltage control in power supplies
- 测试和测量设备 Test & Measurement equipment
- 医疗设备 Medical Equipment
- 户外电子应用 Outdoor Electronic Applications

构造 Construction

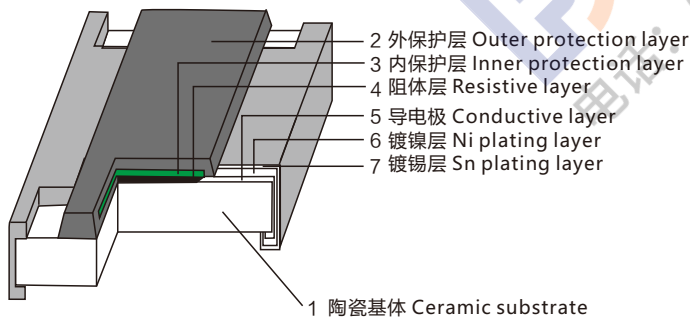

功率衰减曲线 Power Derating Curve

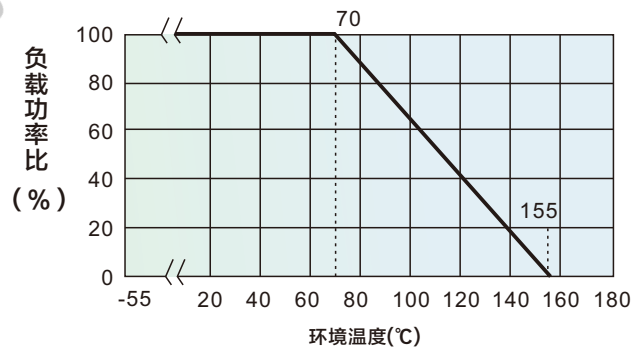

订货方式 (例如1225 1% 2W 20Ω)

Ordering Procedure (Example 1225 1% 2W 20Ω)

料号 (Part Number) : AW1225FB20R0G

AW	1225	F	B	20R0	G
类型 (Type) AW: 抗硫车用宽电极厚膜贴片电阻 (Anti-Sulfuration wide Terminal thick film chip resistors)	尺寸 (Size) 0612 1020 1225	公差 Tolerance F= ±1% J= ±5%	额定功率 Rated Power 1= 1W 2= 3/4W B= 2W	阻值 Resistance Value ±1% : 20R0=20Ω 49R9=49.9Ω 1002=10KΩ ±5% : 06R8=6.8Ω 0200=20Ω 0564=560KΩ	包装代码 Packing Code G= reel (卷装) V= bulk (散料) S= Double Standard Quantity (两倍卷盘标准包装量)

特性 Characteristics

类型 Type	AW0612	AW1020	AW1225
额定功率 70°C Rated Power at 70°C	3/4W	1W	2W
最大工作电压 Max Working Voltage	200V	200V	200V
最大过负荷电压 Max Overload Voltage	400V	400V	400V
绝缘耐压 WithStanding Voltage Dielectric	570V	710V	710V
操作温度范围 Operating Temperature	-55~+155°C	-55~+155°C	-55~+155°C
零欧姆阻值 Resistance Value of Jumper	<50mΩ	<50mΩ	<50mΩ
零欧姆额定电流 Rated Current of Jumper	2.0A	2.0A	2.0A
零欧姆电阻最大电流 Max Current of Jumper	10.0A	10.0A	10.0A
1%阻值范围 Resistance Range of 1%	1Ω-1MΩ	1Ω-1MΩ	1Ω-1MΩ
5%阻值范围 Resistance Range of 5%	1Ω-1MΩ	1Ω-1MΩ	1Ω-1MΩ

外形尺寸 Dimension

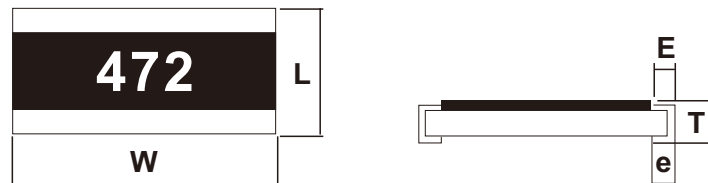

类型 Type		RW0612	RW1020	RW1225
尺寸 Dimension	L(mm)	1.60±0.15	2.50±0.15	3.10±0.15
	W(mm)	3.20±0.20	5.00±0.15	6.30±0.15
	T(mm)	0.60±0.10	0.60±0.10	0.60±0.10
	E(mm)	0.30±0.20	0.40±0.20	0.45±0.20
	e(mm)	0.45±0.15	0.75±0.15	0.75±0.15

标准包装数量 Standard Packing Quantity

0612: 5,000Pcs Per Reel(每卷5,000Pcs)

1020/1218/1225: 4,000Pcs Per Reel(每卷4,000Pcs)

性能 Performance Specifications

内容 Item	测试方法 Test Methods	规格 Specification Limits
温度系数 Temperature Coefficient	JIS C5201 4.8	$1\Omega \leq R \leq 10\Omega$: ± 200 PPM/ $^{\circ}\text{C}$ $10\Omega < R \leq 1\text{M}\Omega$: ± 100 PPM/ $^{\circ}\text{C}$
焊锡性 Solderability	J-STD-002	最少95%面积上锡 Min 95% coverage
绝缘电阻 Insulation Resistance	JIS C5201 4.6	> 10G Ω
绝缘耐压 Dielectric Withstanding Voltage	JIS C5201 4.7	无击穿、飞弧及可见机械性损伤 No evidence of flashover, mechanical damage arcing or insulation breakdown
短时间过负荷 Short-Time Overload	JIS C5201 4.13	$\pm(1.0\% + 0.0.05\Omega)$ Max(最大)
端子弯曲 Terminal Bending	AEC-Q200-005	$\pm(1.0\% + 0.0.05\Omega)$ Max(最大)
抗焊锡热 Resist to Soldering Heat	MIL-STD-202 METHOD 210	$\pm(1.0\% + 0.05\Omega)$ Max(最大)
负荷寿命 Load Life	MIL-STD-202 METHOD 108	$\pm(2.0\% + 0.05\Omega)$ Max(最大)
耐湿特性 Humidity	MIL-STD-202 METHOD 103	$\pm(2.0\% + 0.05\Omega)$ Max(最大)
温度循环 Temperature Cycling	JESD22 METHOD JA-104	$\pm(2.0\% + 0.05\Omega)$ Max(最大)
温湿循环 Moisture Resistance	MIL-STD-202 METHOD106	$\pm(2.0\% + 0.05\Omega)$ Max(最大)
高温储存 High Temperature Exposure(Storage)	MIL-STD-202 METHOD108	$\pm(1.0\% + 0.05\Omega)$ Max(最大)
ESD试验 ESD test	AEC-Q200-002	$\pm(3.0\% + 0.05\Omega)$ Max(最大)
抗硫化试验 Sulfuration test	ASTM-B-809-95	$\pm(3.0\% + 0.05\Omega)$ Max(最大)

内容 Item	测试条件 Test Conditions
温度系数 Temperature Coefficient	JIS C5201 4.8 $TCR = (R - R_0) / (t - t_0) R_0 \times 10^6$ (ppm) R ₀ 电阻在室温下的阻值(resistance at room temperature) R 电阻在125°C或-55°C下的阻值(resistance at 125°C or -55°C) t ₀ 室温(room temperature) t 测试温度 (test temperature 125°C or -55°C)
焊锡性 Solderability	JIS C 5201 4.17 沾助焊剂后浸入锡炉，锡炉温度245±5°C，时间3±0.5秒。 Dip the terminal in a flux and then dip into a soldering bath at 245±5°C for 3±0.5sec.
	J-STD-002 用于引脚型和表面贴装型元件，不需要电气测试. 放大倍数50倍。 测试条件: 表面贴装型: a)方法B, 干热@155°C,4小时,@235°C,3±0.5秒 b)方法B, 蒸煮8小时, @235°C,3±0.5秒 For pin and surface-mount components, no electrical testing required. Magnification 50 times. Test conditions: Surface mount type: a) Method B: dry heat @155°C,4 hours, @235°C,3±0.5 seconds b) Method B: cook for 8 hours at @235°C,3±0.5 seconds
绝缘电阻 Insulation resistance	JIS C 5201 4.6 电阻本体上加绝缘耐压60±5秒后，测量绝缘阻抗 Applied the dielectric withstanding voltage on the center of body for 60±5seconds. Then measure insulation resistance
绝缘耐压 Dielectric withstanding voltage	JIS C 5201 4.7 电阻本体上加绝缘耐压60±5秒。 Applied the dielectric withstanding voltage on the center of body for 60±5seconds.
短时间过负荷 Short-time overload	JIS C 5201 4.13 加载2.5倍的额定电压，时间5秒后测量试验前后的阻值变化率。 Applied 2.5 times of rated voltage for 5 second. Measure the variation of resistance. $\Delta R\% = \frac{R_2 - R_1}{R_1} * 100 \text{----}(\%)$ R1= 试验前阻值(resistance before test) R2= 试验后阻值(resistance after test)
抗焊锡热 Resist to soldering heat	JIS C 5201 4.18 沾助焊剂后浸入锡炉，锡炉温度260±5°C，时间10±0.5秒，测量试验前后的阻值变化率。 Dip the terminal in a flux and then dip into a soldering bath at 260±5°C for 10±0.5sec. Measure the variation of resistance. $\Delta R\% = \frac{R_2 - R_1}{R_1} * 100 \text{----}(\%)$ R1= 试验前阻值(resistance before test) R2= 试验后阻值(resistance after test)
	MIL-STD-202 METHOD 210 锡炉温度260±5°C,时间10±0.5秒，样品不进行预热。注意:单一波峰焊-表面贴装元件按程序，浸入器件本体的1.5mm的深度。 Soldering bath at 260±5°C for 10±0.5sec. No pre-heat of samples. Note: Single Wave Solder-Procedure 2 for SMD and Procedure 1 for Leaded with solder within 1.5mm of device body. $\Delta R\% = \frac{R_2 - R_1}{R_1} * 100 \text{----}(\%)$ R1= 试验前阻值(resistance before test) R2= 试验后阻值(resistance after test)

内容 Item	测试条件 Test Conditions
<p>端子弯曲 Terminal bending</p>	<p>JIS C 5201 4.33 电阻焊接在测试板上进行弯折,弯折保持时间20 ± 1秒, 1206(含) 以下的尺寸弯曲$5 + 0.2/0$ mm; 1206以上的尺寸弯曲$2 + 0.2/0$ mm; 量测试试验前后阻值变化率 Specimen shall be mounted on test board, then bend the board and maintained for 20 ± 1s. the distance of bending is $5 + 0.2/0$ mm for resistors which size no larger than 1206 or $2 + 0.2/0$ mm which size larger than 1206. Measure the variation of resistance.</p> <p style="text-align: center;"> $\Delta R\% = \frac{R_2 - R_1}{R_1} * 100 \text{----}(\%)$ R1=试验前阻值(resistance before test) R2=试验后阻值(resistance after test) </p>
<p>端子弯曲 Board Flex</p>	<p>AEC-Q200-005 焊接在PCB板上, 0201 ~ 1206弯板深度5mm, 1210以上弯板深度2mm; 保持60 ± 1s Reflow solder the samples on PCB, 0201 ~ 1206 bending plate depth 5mm, 1210 above bending plate depth 2mm; Keep 60 ± 1 s</p> <p style="text-align: center;"> $\Delta R\% = \frac{R_2 - R_1}{R_1} * 100 \text{----}(\%)$ R1=试验前阻值(resistance before test) R2=试验后阻值(resistance after test) </p>

内容 Item	测试条件 Test Conditions
温度循环 Temperature cycling	<p>JIS C 5201 4.19 电阻放入温度循环机中, 温度155±2°C至-55±3°C, 共5个循环。 量测试验前后阻值变化率。 Put specimen in a chamber which temperature can be changed to 155±2°C or -55±3°C, repeated 5 times. Measure the variation of resistance.</p> $\Delta R\% = \frac{R_2 - R_1}{R_1} * 100 \text{----}(\%)$ <p>R1 = 试验前阻值(resistance before test) R2 = 试验后阻值(resistance after test)</p>
	<p>JESD22 METHOD JA-104 -55°C~+ 155°C, 循环1000次, 在每一个极限温度持续时间不超过30分钟, 且温度转换时间不超过1分钟, 试验结束24±4小时后进行测试。 1000 Cycles (-55°C to +155°C) Measurement at 24±4 hours after test conclusion. 30min maximum dwell time at each temperature extreme. 1min. maximum transition time.</p> $\Delta R\% = \frac{R_2 - R_1}{R_1} * 100 \text{----}(\%)$ <p>R1 = 试验前阻值(resistance before test) R2 = 试验后阻值(resistance after test)</p>
温湿循环 Moisture resistance	<p>MIL-STD-202 METHOD 106 25°C~65°C, 90~100%RH, 2.5小时; 65°C 90~100%RH, 3小时; 65°C~25°C, 80~100%RH, 2.5小时, 10个循环, 试验结束24±4小时后进行测试。 25°C~65°C, 90~100%RH, 2.5H; 65°C 90~100%RH, 3H; 65°C~25°C 80~100%RH, 2.5H, 10 cycles, Measurement at 24±4 hours after test conclusion.</p> $\Delta R\% = \frac{R_2 - R_1}{R_1} * 100 \text{----}(\%)$ <p>R1 = 试验前阻值(resistance before test) R2 = 试验后阻值(resistance after test)</p>
负荷寿命 Load life	<p>JIS C 5201 4.25.1 电阻放入恒温箱中, 温度70±2°C, ON TIME:1.5H, OFF TIME:0.5H, 通电额定电压1000⁺²⁴/₋₀小时, 量测试验前后阻值变化率。 Put the specimen in a chamber at 70±2°C temperature, ON TIME:1.5H, OFF TIME:0.5H, and applied rated voltage for 1000⁺²⁴/₋₀H. Measure the variation of resistance.</p> $\Delta R\% = \frac{R_2 - R_1}{R_1} * 100 \text{----}(\%)$ <p>R1 = 试验前阻值(resistance before test) R2 = 试验后阻值(resistance after test)</p>
负荷寿命 Operational life	<p>MIL-STD-202 METHOD 108 恒定温度125°C加载额定功率, ON TIME:1.5H, OFF TIME:0.5H, 额定电压1000⁺²⁴/₋₀小时 Load rated power, ON TIME:1.5H, OFF TIME:0.5H, rated voltage 1000⁺²⁴/₋₀ hours</p> $\Delta R\% = \frac{R_2 - R_1}{R_1} * 100 \text{----}(\%)$ <p>R1 = 试验前阻值(resistance before test) R2 = 试验后阻值(resistance after test)</p>
耐湿特性 Humidity	<p>JIS C 5201 4.24 电阻放入恒温恒湿箱, 温度40±2°C, 湿度90~95 %RH; 通电额定电压1.5小时, 断电0.5小时; 重复通断电至试验时间1000 +48/-0 小时. 量测试验前后阻值变化率。 Put the specimen in a chamber at 40±2°C temperature and 90~95% relative humidity, then applied rated voltage for 1.5H and rested for 0.5H repeatedly till total test time is 1000 +48/-0 .. Measure the variation of resistance.</p> $\Delta R\% = \frac{R_2 - R_1}{R_1} * 100 \text{----}(\%)$ <p>R1 = 试验前阻值(resistance before test) R2 = 试验后阻值(resistance after test)</p>

内容 Item	测试条件 Test Conditions
耐湿特性 Biased Humidity	<p>MIL-STD-202 METHOD 103 加载10%额定功率, 85°C/85%RH, 持续通电1000H, 试验结束24±4小时后进行测试 1000 hours 85°C/85%RH. Note: Specified conditions: 10% of operating power. Measurement at 24±4 hours after test conclusion.</p> $\Delta R\% = \frac{R_2 - R_1}{R_1} * 100 \text{----}(\%)$ <p>R1 = 试验前阻值(resistance before test) R2 = 试验后阻值(resistance after test)</p>
高温储存 High Temperature Exposure (Storage)	<p>MIL-STD-202 METHOD 108 155°C下放置1000h, 不加载功率, 试验结束24±4小时后进行测试. 1000 hrs. @ T=155°C. Unpowered. Measurement at 24±4 hours after test conclusion</p> $\Delta R\% = \frac{R_2 - R_1}{R_1} * 100 \text{----}(\%)$ <p>R1 = 试验前阻值(resistance before test) R2 = 试验后阻值(resistance after test)</p>
ESD试验 ESD test	<p>AEC-Q200-002 加载规定静电电压2次/间隔1秒, 0201/0402规格: 0.5KV, 0603规格: 1KV, 其它规格2KV: 0201/0402: 0.5KV, 0603: 1.0KV, Other: 2KV, 2times/1s</p> $\Delta R\% = \frac{R_2 - R_1}{R_1} * 100 \text{----}(\%)$ <p>R1 = 试验前阻值(resistance before test) R2 = 试验后阻值(resistance after test)</p>
抗硫化试验 Sulfurston test	<p>ASTM-B-809-95 汽车电阻: 方法一: 温度60°C, 湿热蒸硫粉试验 (加饱和硝酸钾) 750hrs 方法二: 切削油:硫粉=96.5:3.5, 温度60°C, 100 hrs; 预处理: 前后先经历3次回流焊+100次温冲 Method 1: steam sulfur powder test (with saturated potassium nitrate) at 60°C with humidity and heat (750hrs) Method 2: cutting oil: sulfur powder =96.5:3.5, temperature 60°C, 100 hrs; Pretreatment: before and after three reflow soldering + 100 thermal shock</p> $\Delta R\% = \frac{R_2 - R_1}{R_1} * 100 \text{----}(\%)$ <p>R1 = 试验前阻值(resistance before test) R2 = 试验后阻值(resistance after test)</p> <p>抗硫化电阻: 方法一: 温度105°C, 湿热蒸硫粉试验 (加饱和硝酸钾) 750hrs 方法二: 切削油:硫粉=96.5:3.5, 温度105°C, 100H; 预处理: 前后先经历3次回流焊+100次温冲 Method 1: steam sulfur powder test (with saturated potassium nitrate) at 105°C with humidity and heat (750hrs) Method 2: cutting oil: sulfur powder =96.5:3.5, temperature 105°C, 100H; Pretreatment: before and after three reflow soldering + 100 thermal shock</p> $\Delta R\% = \frac{R_2 - R_1}{R_1} * 100 \text{----}(\%)$ <p>R1 = 试验前阻值(resistance before test) R2 = 试验后阻值(resistance after test)</p>
脉冲 Pulse	<p>IEC 60115-1 4.27 按照脉冲功率曲线加载脉冲功率1次, 测试试验前后阻值变化率. Load pulse power 1 time according to Curve of pulse duration. Measure the variation of resistance.</p> $\Delta R\% = \frac{R_2 - R_1}{R_1} * 100 \text{----}(\%)$ <p>R1 = 试验前阻值(resistance before test) R2 = 试验后阻值(resistance after test)</p>

包装规格 (Tapping Specification)

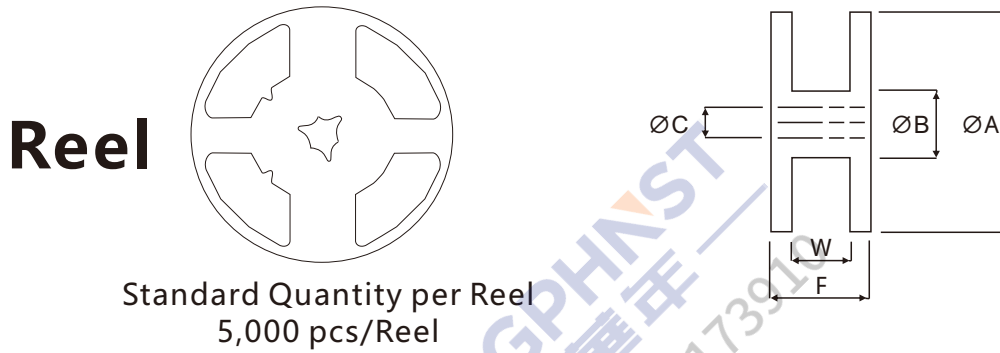

尺寸 Dimensions		A	B	C	F	W
1005	mm	178±2.0	60.0±1.0	13.5±0.5	11.4±0.1	9.00±0.03
0201						
0402						
0603						
0805						
1206						
1210	Inch	7.008±0.079	2.362±0.039	0.531±0.020	0.449±0.039	0.354±0.012
0204						
0306						
0508						
0612						
0816						
1812	mm	178±2.0	60.0±1.0	13.5±0.5	15.4±1.0	13.0±0.3
2010						
2512						
1020	Inch	7.008±0.079	2.362±0.039	0.531±0.020	0.606±0.039	0.512±0.012
1225						

备注 (Remark) :

- (1) 01005 每卷20,000pcs (01005为1005规格尺寸)
01005 Quantity per Reel 20,000pcs/Reel (01005 is 1005 size)
- (2) 0201/0402/CA024A 每卷10,000pcs
0201/0402 Quantity per Reel 10,000pcs/Reel
- (3) 1812/2010/2512 每卷4,000pcs
1812/2010/2512 Quantity per Reel 4,000pcs/Reel
- (4) 0603/0805/1206/1210/CA034A 每卷5,000pcs
0603/0805/1206/1210 Quantity per Reel 5,000pcs/Reel
- (5) 0402可依客户要求 每卷20,000pcs
0402 Quantity per Reel 20,000pcs/Reelas customer requirement

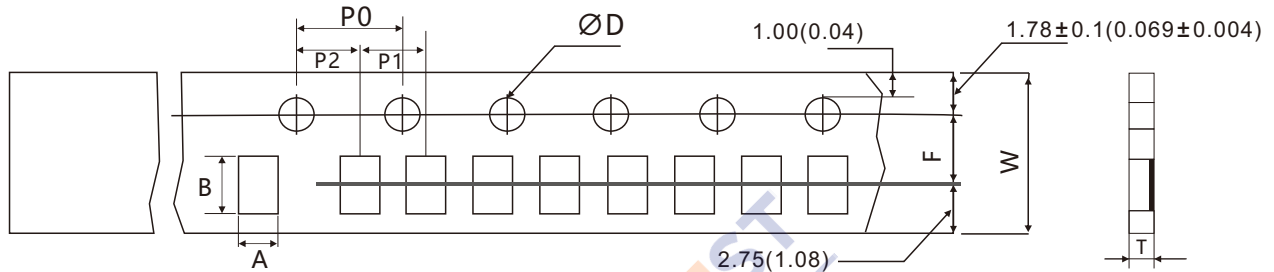

单位毫米 Unit:mm

Dimension	A	B	D	F	P0	P1	P2	W	T
01005	0.24±0.05	0.45±0.05	1.5± ^{0.1} / _{0.0}	3.50±0.05	4.00±0.10	2.00±0.05	2.00±0.05	8.00±0.20	0.40±0.07
0201	0.38±0.05	0.68±0.05	1.5± ^{0.1} / _{0.0}	3.50±0.05	4.00±0.10	2.00±0.10	2.00±0.05	8.00±0.20	0.42±0.07
0402 0204	0.65±0.10	1.15±0.10	1.5± ^{0.1} / _{0.0}	3.50±0.05	4.00±0.10	2.00±0.10	2.00±0.05	8.00±0.20	0.42±0.07
0603 0306	1.10±0.10	1.90±0.10	1.5± ^{0.1} / _{0.0}	3.50±0.05	4.00±0.10	4.00±0.10	2.00±0.05	8.00±0.20	0.60±0.07
0805 0508	1.65±0.20	2.40±0.20	1.5± ^{0.1} / _{0.0}	3.50±0.05	4.00±0.10	4.00±0.10	2.00±0.05	8.00±0.20	0.75±0.07
1206 0612	2.00±0.20	3.60±0.20	1.5± ^{0.1} / _{0.0}	3.50±0.05	4.00±0.10	4.00±0.10	2.00±0.05	8.00±0.20	0.75±0.07
RM1206	2.0±0.15	3.6±0.20	1.5± ^{0.1} / _{0.0}	3.50±0.05	4.00±0.10	4.00±0.10	2.00±0.05	8.00±0.20	0.84±0.10
1210	2.80±0.20	3.50±0.20	1.5± ^{0.1} / _{0.0}	3.50±0.05	4.00±0.10	4.00±0.10	2.00±0.05	8.00±0.20	0.75±0.07
1812	3.30±0.20	4.60±0.20	1.5± ^{0.1} / _{0.0}	5.50±0.05	4.00±0.10	4.00±0.10	2.00±0.05	12.0±0.10	1.0±0.07
2010 1020	2.90±0.10	5.30±0.10	1.5± ^{0.1} / _{0.0}	5.50±0.05	4.00±0.10	4.00±0.10	2.00±0.05	12.0±0.10	1.0±0.07
2512 1225	3.40±0.10	6.60±0.10	1.5± ^{0.1} / _{0.0}	5.50±0.05	4.00±0.10	4.00±0.10	2.00±0.05	12.0±0.10	1.0±0.07
RM2512	3.60±0.2 /-0.18	6.90±0.20	1.5± ^{0.1} / _{0.0}	5.50±0.05	4.00±0.10	4.00±0.10	2.00±0.05	12.0±0.20	1.0±0.15

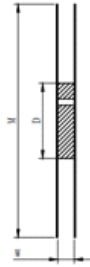
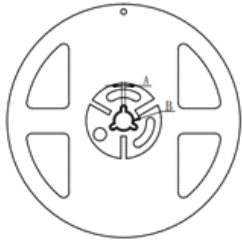

Reel Type	W	M	A	B	D
RZ2512 for 16mm tape	17.0±1.0	330±2.0	2.0±0.5	13.5±0.5	60.0±1.0
RZ3920 for 24mm tape	25.0±1.0	330±2.0	2.0±0.5	13.5±0.5	60.0±1.0
RZ5930 for 32mm tape	33.0±1.0	330±2.0	2.0±0.5	13.5±0.5	60.0±1.0

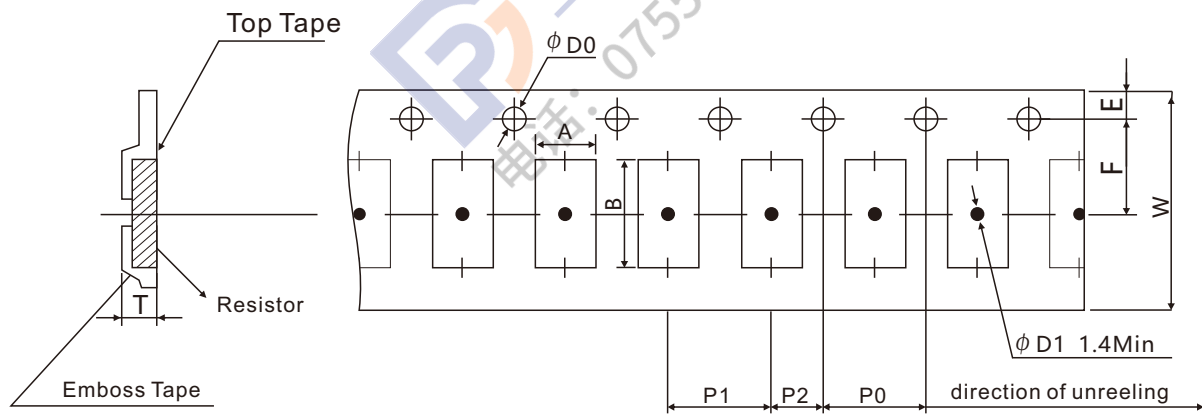

Type	A	B	W	E	F	P0	P1	P2	ϕ D0	T	Quantity (PCS)
RZ2512	3.5±0.1	6.8±0.1	16±0.2	1.75±0.1	5.5±0.1	4.0±0.1	8.0±0.1	2.0±0.1	1.5±0.1	1.8±0.2	4000
RZ3920	5.7±0.1	11.2±0.1	24±0.2	1.75±0.1	7.5±0.1	12±0.1	12±0.1	6.0±0.1	1.5±0.1	2.5±0.2	2000
RZ5930	8.2±0.1	16.1±0.1	32±0.2	1.75±0.1	11.5±0.1	12±0.1	12±0.1	6.0±0.1	1.5±0.1	2.5±0.2	2000

特性 Features

- 1.表面贴装组件，适合应用于表面自动贴装应用。
Surface Mounted Device(SMD), Suitable for Auto-placement Surface Mounting Application
- 2.电极表面为电镀锡，适合波峰焊和回流焊。
Matte Tin Plating Termination Layer for Reflow & Wave Soldering
- 3.产品基材为氧化铝陶瓷基板，具有抗高热量及机械应力的能力
Aluminum Oxide Ceramic Substrate as Body, High Thermal and Mechanical Resist

应用 Application

- 1.快速切换Fast Switching
- 2.适合各种电子电路板For General Purpose on Electronics Circuit Board

标识 Marking

标识为负电极Marking as Cathode Terminal

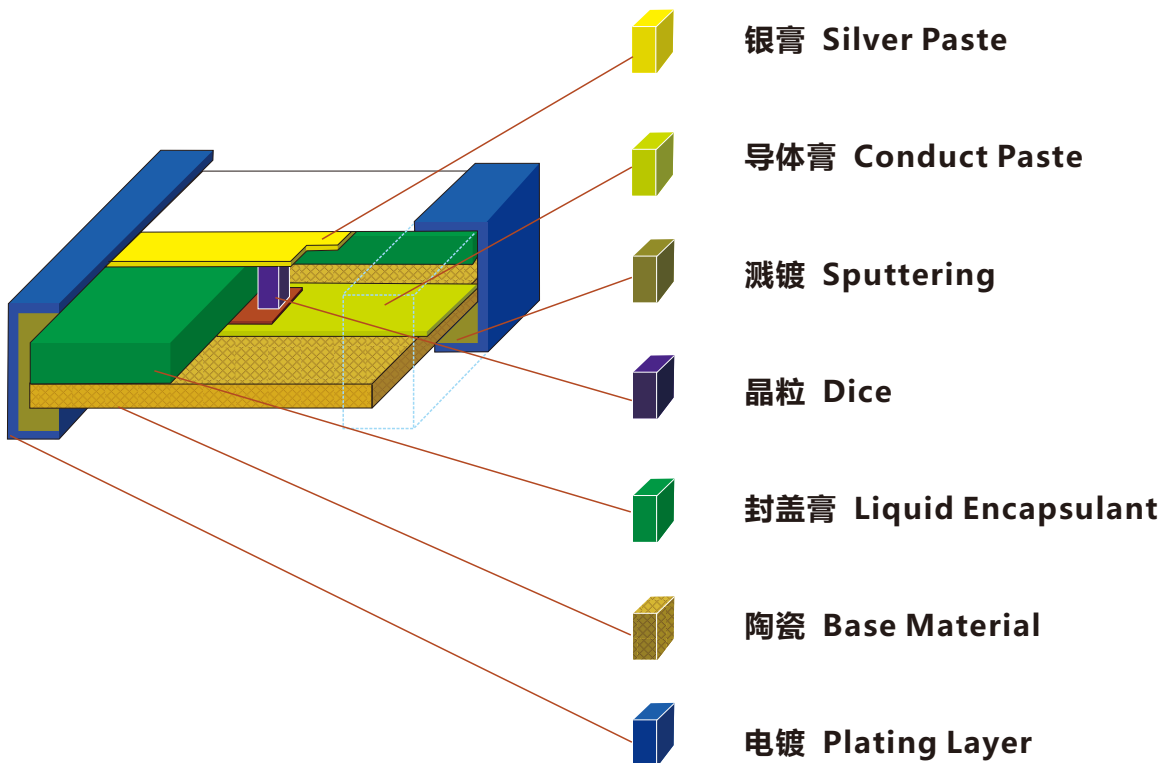
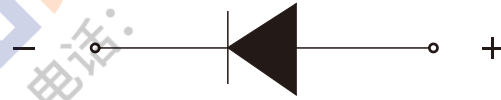

产品尺寸 Product Size



单位Unit:mm

系列Series	CD4148WP(1206)	CD4148WSP(0805)	CD4148WTP(0603)
长L	3.20±0.20	2.00±0.20	1.55±0.10
宽W	1.50±0.20	1.25±0.20	0.80±0.10
高T	0.75±0.10	0.75±0.10	0.65±0.10
背导线长C	0.55±0.20	0.45±0.20	0.35±0.10

特性曲线 Characteristic Curve

正向特性Figure 1.Forward characteristic

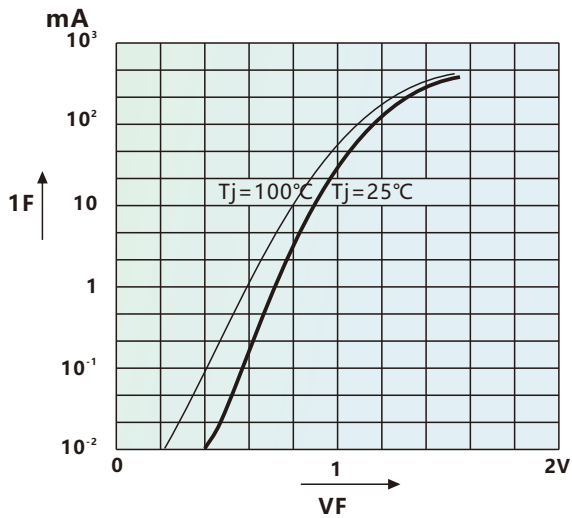

功率衰减Figure 2.Power De-rating

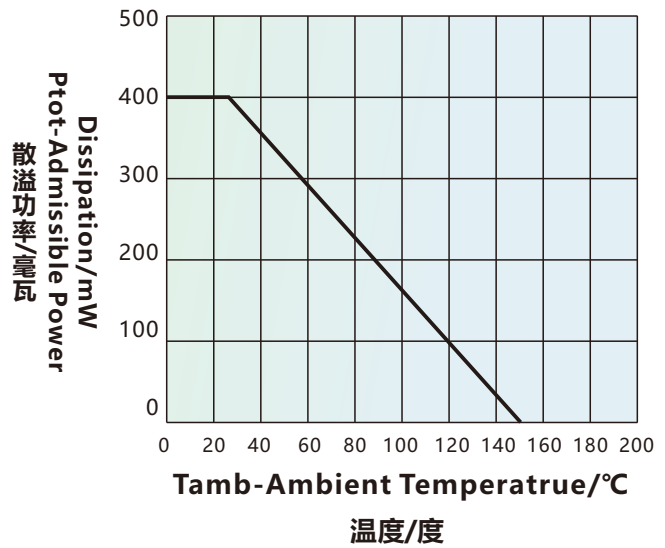

电气特性, 温度=25°C Electrical Characteristic, Tamb=25°C

系列 Series		CD4148WP	CD4148WSP	CD4148WTP	CD4148WN	CD4148WSN	CD4148WTN
尺寸代码 (英寸/毫米) Size Code(Inch/mm)		1206 (3216)	0805 (2012)	0603 (1608)	1206 (3216)	0805 (2012)	0603 (1608)
操作温度 Operating Temperature		-55 ~ +150°C					
散溢温度 Powr Dissipation	Ptot	400mW	200mW	200mW	500mW	200mW	200mW
可重复反向峰值电压 Repetitive Peak Revers Voltage	VRRM	75V	75V	75V	100V	100V	90V
重复恢复电流 Repetitive Peak Forward Current	IFRM	300mA	300mA	225mA	300mA	300mA	225mA
非重复正向电流 Non-repetitive Surge Forward Current,at t < 1s	IFSM	500mAMax	500mAMax	400mAMax	500mAMax	500mAMax	400mAMax
平均整流电流 Average Rectified Current,at f > =50Hz	IF(AV)	150mAMax	150mAMax	100mAMax	150mAMax	150mAMax	100mAMax
顺向电压 Forward Voltage,at 10mA	VF	1.0V Max	1.0V Max	1.0V Max	1.0V Max	1.0V Max	1.0V Max
漏电流 Leakage Current,at 20V	IR	25nA Max	25nA Max	25nA Max	25nA Max	25nA Max	25nA Max
漏电流 Leakage Current,at 75V		5uA Max	5uA Max	5uA Max			
漏电流 Leakage Current,at 80V					0.5uA Max	0.5uA Max	0.1uA Max
电容Capacitance,at VF=VR=0V	Ctot	4pF Max	4pF Max	4pF Max	4pF Max	4pF Max	3pF Max
反向恢复时间Reverse Recovery Time,at IF= 10mA&IR= 1mA	Trr	4ns Max	4ns Max	4ns Max	4ns Max	4ns Max	4ns Max

特性测试 Test Characteristic

测试项目 Test Item	测试条件 Test Condition	规格 Requirement
可焊性 Solderability	245±5°C, 2±0.5秒锡炉浸锡 Sn bath at 245±5°C for 2±0.5s	焊锡面积 > 95% > 95% area tin covered
焊接耐热 Resistance To Soldering Heat	没有物理破损, 电性在规格内 Sn bath at 260±5°C for 10±2s 260±5°C, 10±1秒	V _{F1} V _R & I _R 电性在规格内, 外观没有破损 V _{F1} V _R & I _R within spec; no mechanical damage
高温高湿 Humidity Steady State	85±5°C 85%RH 条件下保持168小时. At 85±5°C 85%RH for 168hrs	V _{F1} V _R & I _R 电性在规格内 V _{F1} V _R & I _R Within Spec
连续顺向负荷寿命 Continue Forward Operating Life	IF=1.1*IO(165mA), 保持1000小时. 电性在规格内 At 25°C IF=1.1IF for 1000hrs	V _{F1} V _R & I _R 电性在规格内 V _{F1} V _R & I _R Within Spec
冷热冲击 Thermal Shock	-55±3°C/5分钟→150±3°C/5分钟; 10循环. 电性在规格内 -55±5°C/5min to 150±5°C/5min for 10cycles	V _{F1} V _R & I _R 电性在规格内 V _{F1} V _R & I _R Within Spec
弯折 Bending Strength	弯曲2mm. 外观没有破损, 电性在规格 Bending up to 2mm for 1 cycle	V _{F1} V _R & I _R 电性在规格内, 外观没有破损 V _{F1} V _R & I _R Within Spec; no mechanical damage

包装 Packing

组件的纸带及卷盘的规格如"IEC 60286-3自动封装处理

Components tape and reel specifications are referring to "IEC 60286-3 Packaging of components for automatic handling

卷盘尺寸 Reel Dimensions

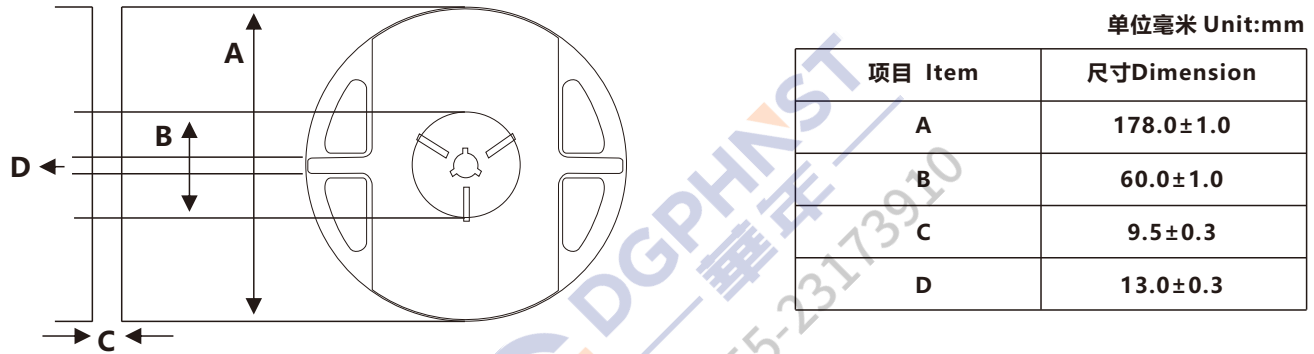

纸带尺寸 Tape Dimensions

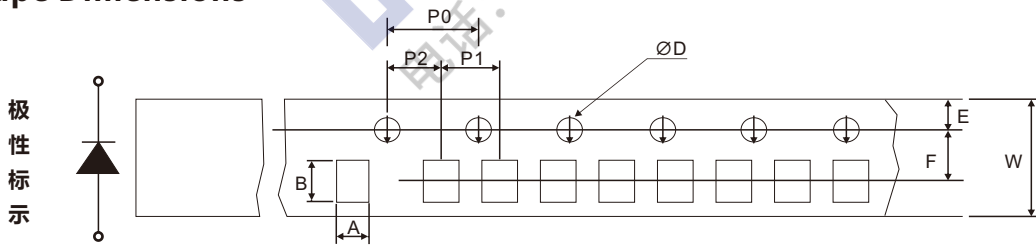

单位毫米 Unit:mm

尺寸 Dimension	1206	0805	0603
A	2.00±0.20	1.65±0.20	1.10±0.10
B	3.60±0.20	2.40±0.20	1.90±0.10
W	8.00±0.20	8.00±0.20	8.00±0.20
D	1.50±0.10	1.50±0.10	1.50±0.10
E	1.75±0.10	1.75±0.10	1.75±0.10
F	3.50±0.10	3.50±0.10	3.50±0.10
P0	4.00±0.10	4.00±0.10	4.00±0.10
P1	4.00±0.10	4.00±0.10	4.00±0.10
P2	2.00±0.05	2.00±0.05	2.00±0.05

上胶带剥离 Top Tape Peeling

上胶带剥离角度在165°~180°之间，从载体上剥离角度如下图所示

The top tape peeling-off angle from carrier tape is within 165°C~180°C during application

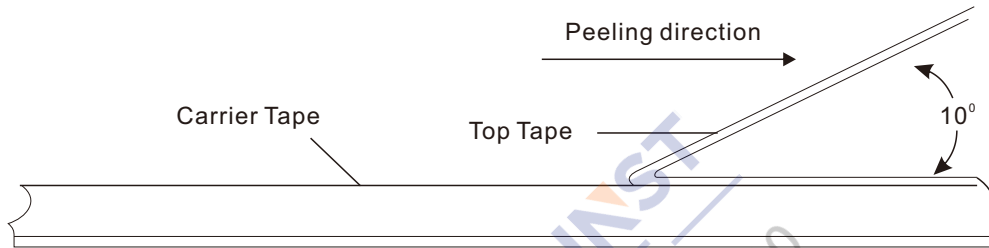

订货方式 Ordering Procedure

订货方式(例如 芯片开关二极管4148 1206 75V Lead Free)

Ordering Procedure (Example Chip Switching Diode 4148 1206 75V)

料号 (Part Number):CD4148WP

CD	4148	W	P
产品系列 Product Series CD:贴片二极管 Chip Diode	产品类别 Product Type 4148:75V 4448:75V(IF=100mA) BAV21: 高压200V (High voltage 200V)	尺寸 Size WQ:0402 WT:0603 WS:0805 W :1206	特别码 Special Code P:无铅Lead-free N:反向电压100V VRRM 100V

卷装数量 Reel Quantity

每卷5,000PCS/5,000PCS Per Reel

储存条件 Storage Condition

由于高温和潮湿或化学环境，产品终端的可焊性会降低。环境温度需在40°C以下，环境相对湿度需小于75%，远离化学物

Product termination solderability can degrade due to high temperature and humidity or chemical environment.

Storage condition must be in an ambient temperature of < 40°C and ambient humidity of < 75%RH, and free from chemical.

免责声明 Disclaimers

以下情况应避免使用这些产品：故障可能造成人身伤亡，严重的财产或环境损害，如医疗，军事，航空，太空或生命支持设备损坏等

These products are not designed for use in applications where any failure or malfunction may result in personal injury, death or severe property or environmental damage such as medical, military, aircraft, space or life support equipments.

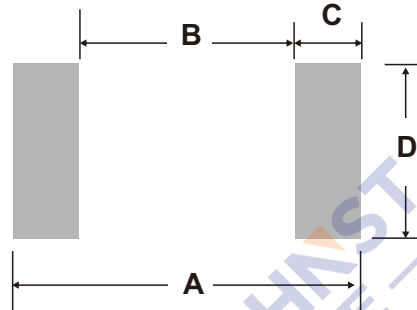
推荐焊盘尺寸 Recommended Soldering PAD

回流焊接/波峰焊接 Reflow/Wave Soldering				
产品尺寸 Product Size	尺寸/毫米 Dimension/mm			
	A	B	C	D
1206	3.8-4.6	2.2	0.8-1.2	1.5-1.7
0805	2.6-3.4	1.2	0.7-1.1	1.2-1.4
0603	1.8-2.6	0.8	0.5-0.9	0.8-1.0

焊接条件与提示 Soldering Condition & Caution

推荐焊接条件 Recommended Soldering Condition (Refer to IPC/JEDEC J-STD-020D 4-1&5.2)			
推荐曲线条件 Recommended Profile Condition	锡铅焊接 Sn-Pb Soldering	无铅焊接 Lead free Soldering	波峰焊接 Wave Soldering
升温速度 (从预热阶段开始) Ramp-up Rate (From Pre-heat Stage)	< 3°C/s	< 3°C/s	Δ T < 150°C
预热温度与时间 Pre-heat Temperature & Time	100-150°C 60-120s	150-200°C 60-120s	100-150°C 60-120s
焊接温度与时间 Soldering Temperature & Time	183°C 60-150s	217°C 60-150s	260±5°C 5±2s
最高温度 Peak Temperature	230±5°C < 260°C	240±5°C < 260°C	260±5°C
最高温度为5°C的时间 Time Within 5°C of Peak Temperature	10-20s	20-30s	—
降温速度 Ramp-down Rate	< 6°C/s	< 6°C/s	< 6°C/s
从25°C到最高温度时间 Time 25°C to Peak Temperature	< 6min	< 8min	—
手工烙铁焊接条件: 350°C 3S, 避免烙铁头直接接触材料本体 Manual Soldering: Approx. 350°C for 3s, avoid solder iron tip direct touch component's body			

推荐焊接温度曲线 Reommended Soldering Profile

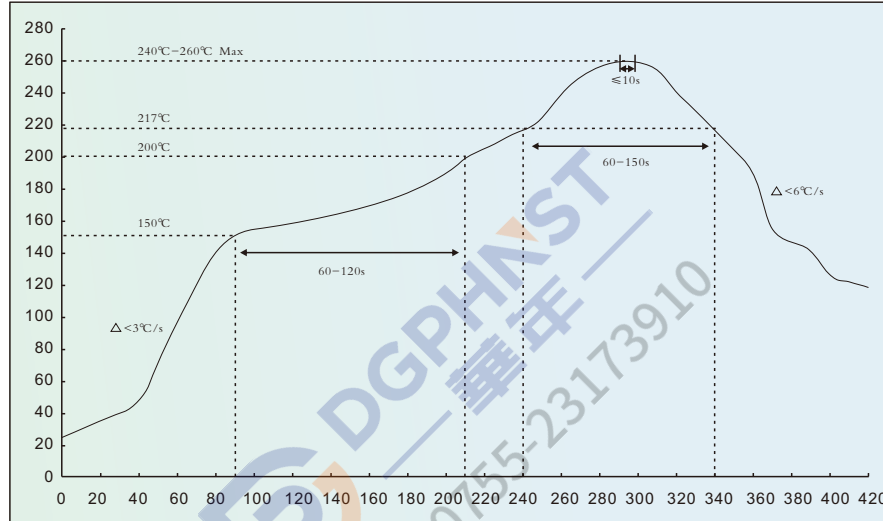

图一：无铅回流焊接温度曲线（锡银铜）
Fig1:Reflow Soldering Profile for Lead-free Solder(SnAgCu)

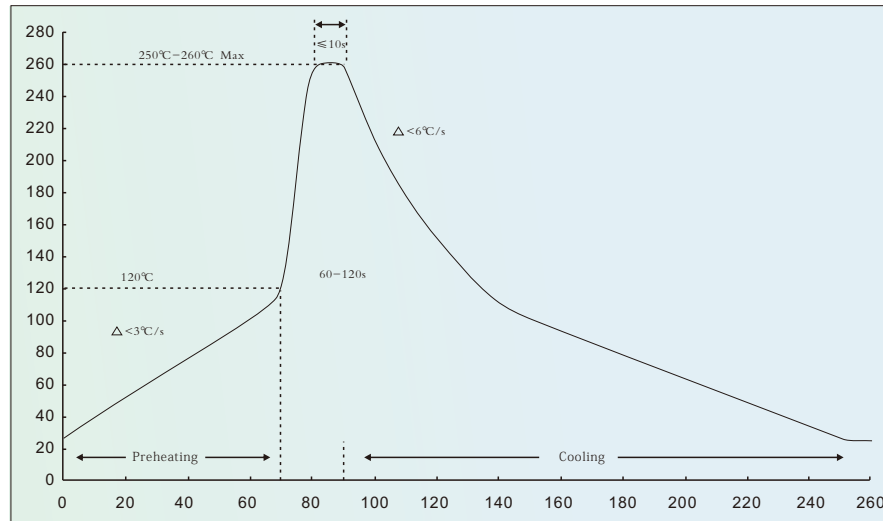

图二：波峰焊接温度曲线
Fig2:wave Soldering Profile

1.推荐的配置文件是指IPC/JEDEC J-STD-020D & IEC-60068-2-58

The recommended profiles are referring to IPC/JEDEC J-STD-020D & IEC-60068-2-58

2.贴片二极管能承受最高焊接温度为260摄氏度的最长时间是10秒，最大焊接周期的三倍；参考文献：IEC-60068-2-58

Chip diodes are able to stand maximum soldering temperature up to 260°C max for 10s, and the soldering cycles with max 3 times, referring to IEC-60068-2-58

特性 Features

- 1.SMD模式, 适合各种尺寸
SMD Chip Pattern, Available In Various Dimensions
- 2.电极表面为电镀锡, 适合波峰焊和回流焊
Matte Tin Plating Termination Layer for Reflow & Wave Soldering
- 3.产品基材为氧化铝陶瓷基板, 具有抗高热量及机械应力的能力
Aluminum Oxide Ceramic Substrate as Body, High Thermal and Mechanical Resist

应用 Application

适用于各种电子电路板
For General Purpose on Eleceronics Circuit Board

标识 Marking

标记为肖特基电压代码 & 阴极终端
Marking as Schottky Voltage Code & Cathode Terminal



产品结构 Product Structure

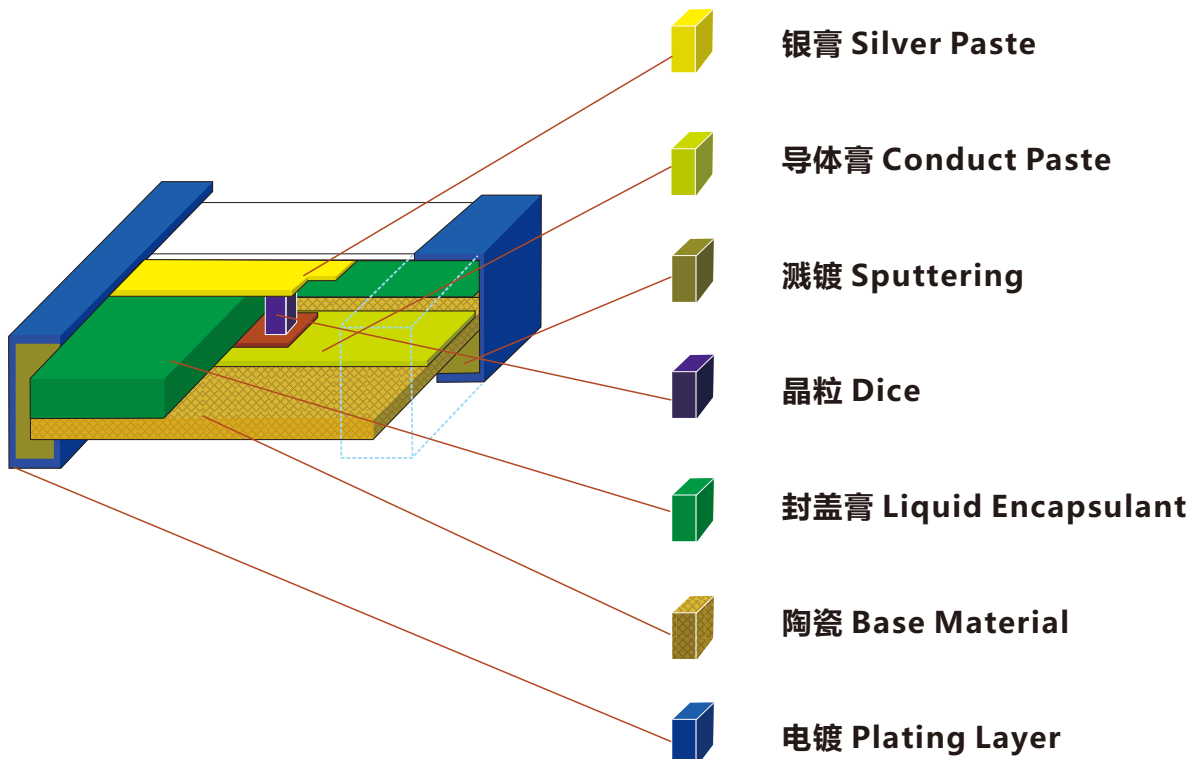

产品尺寸 Product Size

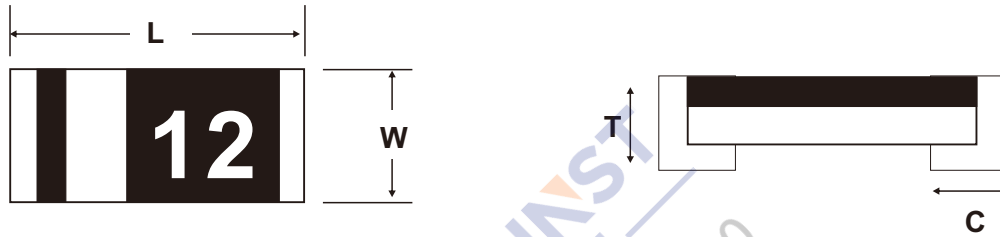

单位Unit:mm

系列 Series	CDZ55	CDZ55-S	CDZ55-T
长L	3.2±0.20	2.00±0.20	1.55±0.10
宽W	1.50±0.20	1.25±0.20	0.80±0.10
高T	0.75±0.10	0.75±0.10	0.65±0.10
背导长C	0.55±0.20	0.45±0.20	0.35±0.10

特性曲线 Characteristic Curve

正向电流和电压 Figure 1. Forward Current vs Forward Voltage

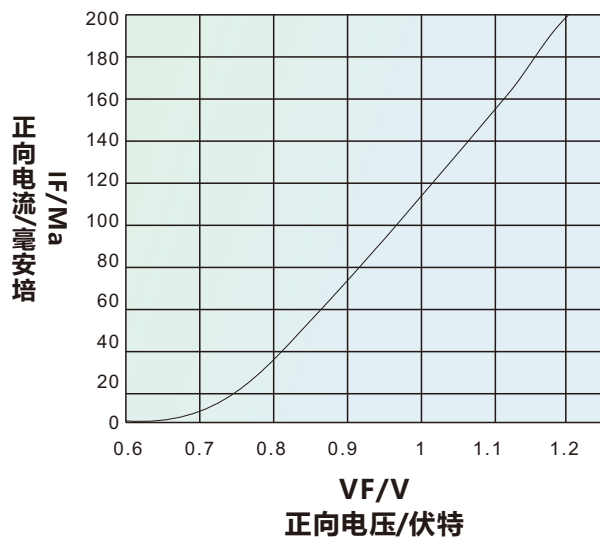

功率衰减 Figure 2. Power De-rating

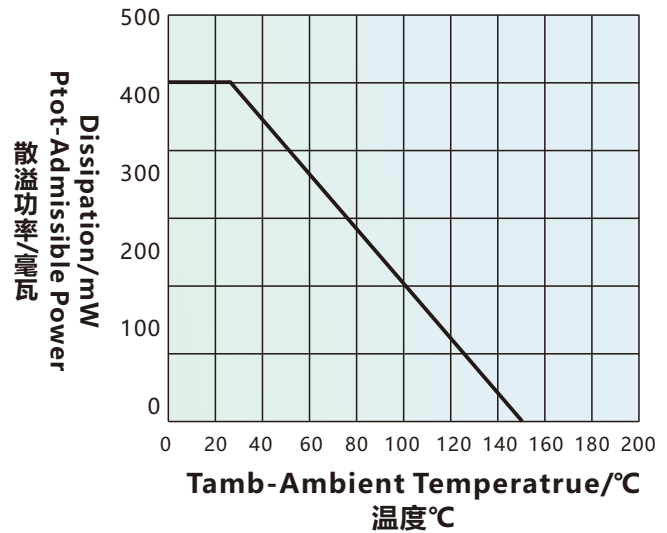

电气特性, 温度=25°C Electrical Characteristic, Tamb=25°C

系列 Series		CDZ55B	CDZ55C	CDZ55B-S	CDZ55C-S	CDZ55B-T	CDZ55C-M	CDZ55C-SM	CDZ55C-TM	
尺寸代码 (英寸/毫米) Size Code(Inch/mm)		1206 (3216)	1206 (3216)	0805 (2012)	0805 (2012)	0603 (1608)	0603 (1608)	0805 (2012)	0603 (1608)	
操作温度 Operating Temperature		-55 ~ +150°C								
散溢功率 Power Dissipation	Ptot	500mW				200mW		500mW	200mW	
顺向电压, 在200毫安 Forward Voltage, at 200mA	VF	1.5V MAX								
齐纳电压公差 Zener Voltage Tolerance		2%	5%	2%	5%	2%	5%	5%	5%	
齐纳电压范围 Zener Voltage Range	VZ	2.4~75V (2.4V only 5%)					5.1~5.6V			
最大齐纳阻抗 Max Zener Impedance	ZZT, ZZK	Refer Next Page Electrical Date					5 Refer Next Page Electrical Date			
最大反向漏电流 Max Reverse Leakage Current	IR						< 100uA@4.2V			

特性测试 Test Characteristic

测试项目 Test Item	测试条件 Test Condition	规格 Requirement
可焊性 Solderability	245±5°C, 2±0.5秒锡炉浸锡 Sn bath at 245±5°C for 2±0.5s	焊锡面积 > 95% > 95% area tin covered
焊接耐热 Resistance To Soldering Heat	没有物理破损, 电性在规格内 Sn bath at 260±5°C for 10±2s 260±5°C, 10±1秒	V _{F1} , V _R & I _R 电性在规格内, 外观 没有破损 V _{F1} , V _R & I _R within spec; no mechanical damage
高温高湿 Humidity Steady State	85±3°C 85%RH 条件下保持168小时. At 85±5°C 85%RH for 168hrs	V _{F1} , V _R & I _R 电性在规格内 V _{F1} , V _R & I _R Within Spec
连续顺向负荷寿命 Continue Forward Operating Life	IF=1.1*IO(165mA), 保持1000小时. 电性在规格内 At 25°C IF=1.1IF for 1000hrs	V _{F1} , V _R & I _R 电性在规格内 V _{F1} , V _R & I _R Within Spec
冷热冲击 Thermal Shock	-55±3°C/5分钟→150±3°C/5分钟; 10循环. 电性在规格内 -55±5°C/5min to 150±5°C/5min for 10cycles	V _{F1} , V _R & I _R 电性在规格内 V _{F1} , V _R & I _R Within Spec
弯折 Bending Strength	弯曲2mm. 外观没有破损, 电性在规格 Bending up to 2mm for 1cycle	V _{F1} , V _R & I _R 电性在规格内, 外观没有 破损 V _{F1} , V _R & I _R Within Spec; no mechanical damage

电性数据Electrical Data

CDZ55B&CDZ55B-S&CDZ55B-T 齐纳电压公差2%

CDZ55B&CDZ55B-S&CDZ55B-T 2% Zener Voltage Tolerance

料号 Part Number		标识 Marking	正常齐纳电压 Nominal Zener Voltage		最大齐纳阻抗 Max Zener Impedance				最大反向漏电流 Max Reverse Leakage Current	
			VZ @ IZT		ZZT @ IZT		ZZK @ IZK		IR @ VR	
CDZ55B	CDZ55B-S		Min V	Max V	Ω	mA	Ω	mA	uA	V
CDZ55B2V7	CDZ55B2V7S	2V7	2.65	2.75	85	5	600	1	10	1
CDZ55B3V0	CDZ55B3V0S	3	2.94	3.06	85	5	600	1	4	1
CDZ55B3V3	CDZ55B3V3S	3V3	3.23	3.37	85	5	600	1	2	1
CDZ55B3V6	CDZ55B3V6S	3V6	3.53	3.67	85	5	600	1	2	1
CDZ55B3V9	CDZ55B3V9S	3V9	3.82	3.98	85	5	600	1	2	1
CDZ55B4V3	CDZ55B4V3S	4V3	4.21	4.39	80	5	600	1	1	1
CDZ55B4V7	CDZ55B4V7S	4V7	4.61	4.79	70	5	600	1	0.5	1
CDZ55B5V1	CDZ55B5V1S	5V1	5.00	5.20	50	5	550	1	0.1	1
CDZ55B5V6	CDZ55B5V6S	5V6	5.49	5.71	30	5	450	1	0.1	1
CDZ55B6V2	CDZ55B6V2S	6V2	6.08	6.32	10	5	200	1	0.1	2
CDZ55B6V8	CDZ55B6V8S	6V8	6.66	6.94	8	5	150	1	0.1	3
CDZ55B7V5	CDZ55B7V5S	7V5	7.35	7.65	7	5	50	1	0.1	5
CDZ55B8V2	CDZ55B8V2S	8V2	8.04	8.36	7	5	50	1	0.1	6.2
CDZ55B9V1	CDZ55B9V1S	9V1	8.92	9.28	10	5	50	1	0.1	6.8
CDZ55B10	CDZ55B10S	10	9.80	10.20	15	5	70	1	0.1	7.5
CDZ55B11	CDZ55B11S	11	10.78	11.22	20	5	70	1	0.1	8.2
CDZ55B12	CDZ55B12S	12	11.79	12.24	20	5	90	1	0.1	9.1
CDZ55B13	CDZ55B13S	13	12.74	13.26	26	5	110	1	0.1	10
CDZ55B15	CDZ55B15S	15	14.70	15.30	30	5	110	1	0.1	11
CDZ55B16	CDZ55B16S	16	15.68	16.32	40	5	170	1	0.1	12
CDZ55B18	CDZ55B18S	18	17.64	18.36	50	5	170	1	0.1	13
CDZ55B20	CDZ55B20S	20	19.60	20.40	55	5	220	1	0.1	15
CDZ55B22	CDZ55B22S	22	21.56	22.44	55	5	220	1	0.1	16
CDZ55B24	CDZ55B24S	24	23.52	24.48	80	5	220	1	0.1	18
CDZ55B27	CDZ55B27S	27	26.46	27.54	80	5	220	1	0.1	20
CDZ55B30	CDZ55B30S	30	29.40	30.60	80	5	220	1	0.1	22
CDZ55B33	CDZ55B33S	33	32.34	33.66	80	5	220	1	0.1	24
CDZ55B36	CDZ55B36S	36	35.28	36.72	80	5	220	1	0.1	27

*39V-75V可用39V-75V Available Upon Request

CDZ55B & CDZ55B-S & CDZ55C-T 齐纳电压公差5%
 CDZ55C & CDZ55C-S & CDZ55C-T 5% Zener Voltage Tolerance

料号 Part Number		标识 Marking	正常齐纳电压 Nominal Zener Voltage		最大齐纳阻抗 Max Zener Impedance			最大反向漏电流 Max Reverse Leakage Current		
			VZ @ IZT		ZZT @ IZT		ZZK @ IZK		IR @ VR	
CDZ55C	CDZ55C-S		Min V	Max V	Ω	mA	Ω	mA	uA	V
CDZ55C2V4	CDZ55C2V4S	2V4	2.28	2.52	85	5	600	1	100	1
CDZ55C2V7	CDZ55C2V7S	2V7	2.57	2.84	85	5	600	1	10	1
CDZ55C3V0	CDZ55C3V0S	3V0	2.85	3.15	85	5	600	1	4	1
CDZ55C3V3	CDZ55C3V3S	3V3	3.14	3.47	85	5	600	1	2	1
CDZ55C3V6	CDZ55C3V6S	3V6	3.42	3.78	85	5	600	1	2	1
CDZ55C3V9	CDZ55C3V9S	3V9	3.71	4.10	85	5	600	1	2	1
CDZ55C4V3	CDZ55C4V3S	4V3	4.09	4.52	80	5	600	1	1	1
CDZ55C4V7	CDZ55C4V7S	4V7	4.47	4.94	70	5	600	1	0.5	1
CDZ55C5V1	CDZ55C5V1S	5V1	4.85	5.36	50	5	550	1	0.1	1
CDZ55C5V6	CDZ55C5V6S	5V6	5.32	5.88	30	5	450	1	0.1	1
CDZ55C6V2	CDZ55C6V2S	6V2	5.89	6.51	10	5	200	1	0.1	2
CDZ55C6V8	CDZ55C6V8S	6V8	6.46	7.14	8	5	150	1	0.1	3
CDZ55C7V5	CDZ55C7V5S	7V5	7.13	7.88	7	5	50	1	0.1	5
CDZ55C8V2	CDZ55C8V2S	8V2	7.79	8.61	7	5	50	1	0.1	6.2
CDZ55C9V1	CDZ55C9V1S	9V1	8.65	9.56	10	5	50	1	0.1	6.8
CDZ55C10	CDZ55C10S	10	9.50	10.50	15	5	70	1	0.1	7.5
CDZ55C11	CDZ55C11S	11	10.45	11.55	20	5	70	1	0.1	8.2
CDZ55C12	CDZ55C12S	12	11.40	12.60	20	5	90	1	0.1	9.1
CDZ55C13	CDZ55C13S	13	12.35	13.65	26	5	110	1	0.1	10
CDZ55C15	CDZ55C15S	15	14.25	15.75	30	5	110	1	0.1	11
CDZ55C16	CDZ55C16S	16	15.20	16.80	40	5	170	1	0.1	12
CDZ55C18	CDZ55C18S	18	17.10	18.90	50	5	170	1	0.1	13
CDZ55C20	CDZ55C20S	20	19.00	21.00	55	5	220	1	0.1	15
CDZ55C22	CDZ55C22S	22	20.90	23.10	55	5	220	1	0.1	16
CDZ55C24	CDZ55C24S	24	22.80	25.20	80	5	220	1	0.1	18
CDZ55C27	CDZ55C27S	27	25.65	28.35	80	5	220	1	0.1	20
CDZ55C30	CDZ55C30S	30	28.50	31.50	80	5	220	1	0.1	22
CDZ55C33	CDZ55C33S	33	31.35	34.65	80	5	220	1	0.1	24
CDZ55C36	CDZ55C36S	36	34.20	37.80	80	5	220	1	0.1	27

*39V-75V可用39V-75V Available Upon Request

包装 Packing

组件的纸带及卷盘的规格如"IEC 60286-3自动封装处理

Components tape and reel specifications are referring to "IEC 60286-3 Packaging of components for automatic handling

卷盘尺寸 Reel Dimensions

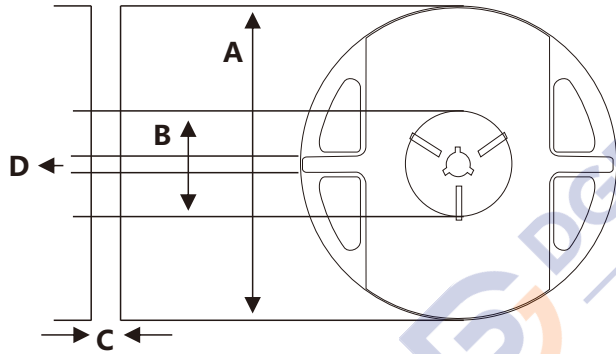

单位毫米 Unit:mm

项目 Item	尺寸 Dimension
A	178.0±1.0
B	60.0±1.0
C	9.5±0.3
D	13.0±0.3

纸带尺寸 Tape Dimensions

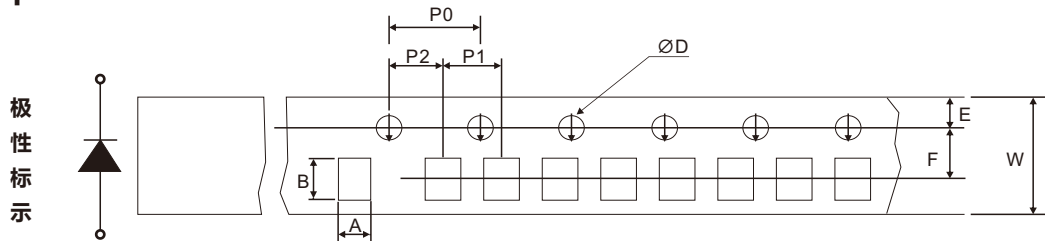

单位毫米 Unit:mm

尺寸 Dimension	1206	0805	0603
A	2.00±0.20	1.65±0.20	1.10±0.10
B	3.60±0.20	2.40±0.20	1.90±0.10
W	8.00±0.20	8.00±0.20	8.00±0.20
D	1.50±0.10	1.50±0.10	1.50±0.10
E	1.75±0.10	1.75±0.10	1.75±0.10
F	3.50±0.10	3.50±0.10	3.50±0.10
P0	4.00±0.10	4.00±0.10	4.00±0.10
P1	4.00±0.10	4.00±0.10	4.00±0.10
P2	2.00±0.05	2.00±0.05	2.00±0.05

上胶带剥离 Top Tape Peeling

上胶带剥离角度在165°~180°之间，从载体上剥离角度如下图所示

The top tape peeling-off angle from carrier tape is within 165°-180° during application

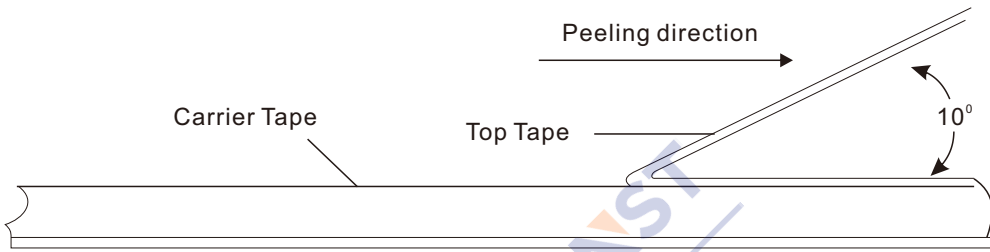

订货方式 Ordering Procedure

订货方式(例如 芯片稳压二极管0805 5% 12V 0.1-0.5W 5mA)

Ordering Procedure (Example Chip Zener Diode 0805 5% 12V 0.1-0.5W 5mA)

料号 (Part Number):CDZ55C12S

CD	Z55	C	12	S	
产品系列 Product Series CD:贴片二极管 Chip Diode	产品类型 Product Type Z55:Zener 0.1-0.5W 5mA Z52:Zener 0.1-0.5W 20mA Z47:Zener 1W	公差 Tolerance B=±2% C=±5% L=±3% M=+5%	电压 Voltage 2V2=2.2V 3V0=3V 12=12V 30=30V	尺寸 Size A:2010(SMA 等同equivalent) S:0805 T:0603 Q:0402	特殊代码 Special Code :Lead-free M:Low IR

卷装数量 Reel Quantity

每卷5,000PCS/5,000PCS Per Reel

储存条件 Storage Condition

由于高温和潮湿或化学环境，产品终端的可焊性会降低.环境温度需在40°C以下，环境相对湿度需小于75%，远离化学物

Product termination solderability can degrade due to high temperature and humidity or chemical environment.

Storage condition must be in an ambient temperature of < 40°C and ambient humidity of < 75%RH,and free from chemical.

免责声明 Disclaimers

以下情况应避免使用这些产品：故障可能造成人身伤亡，严重的财产或环境损害，如医疗，军事，航空，太空或生命支持设备损坏等

These products are not designed for use in applications where any failure or malfunction may result in personal injury,death or severe property or environmental damage such as medical,military,aircraft,space or life support equipments.

推荐焊盘尺寸 Recommended Soldering PAD

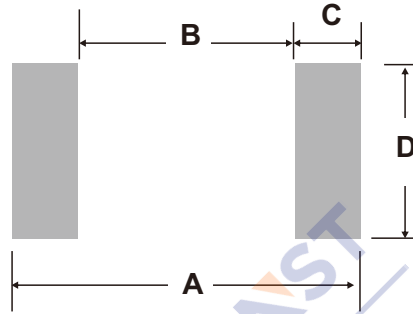

回流焊接/波峰焊接 Reflow/Wave Soldering				
产品尺寸 Product Size	尺寸/毫米 Dimension/mm			
	A	B	C	D
1206	3.8-4.6	2.2	0.8-1.2	1.5-1.7
0805	2.6-3.4	1.2	0.7-1.1	1.2-1.4
0603	1.8-2.6	0.8	0.5-0.9	0.8-1.0

焊接条件与提示 Soldering Condition & Caution

推荐焊接条件 Recommended Soldering Condition (Refer to IPC/JEDEC J-STD-020D 4-1&5.2)			
推荐曲线条件 Recommended Profile Condition	锡铅焊接 Sn-Pb Soldering	无铅焊接 Lead free Soldering	波峰焊接 Wave Soldering
升温速度 (从预热阶段开始) Ramp-up Rate(From Pre-heat Stage)	< 3°C/s	< 3°C/s	Δ T < 150°C
预热温度与时间 Pre-heat Temperature & Time	100-150°C 60-120s	150-200°C 60-120s	100-150°C 60-120s
焊接温度与时间 Soldering Temperature & Time	183°C 60-150s	217°C 60-150s	260±5°C 5±2s
最高温度 Peak Temperature	230±5°C < 260°C	240±5°C < 260°C	260±5°C
最高温度为5°C的时间 Time Within 5°C of Peak Temperature	10-20s	20-30s	—
降温速度 Ramp-down Rate	< 6°C/s	< 6°C/s	< 6°C/s
从25°C到最高温度时间 Time 25°C to Peak Temperature	< 6min	< 8min	—

手工烙铁焊接条件: 350°C 3S, 避免烙铁头直接接触材料本体
Manual Soldering: Approx. 350°C for 3s, avoid solder iron tip direct touch component's body

推荐焊接温度曲线 Reommeded Soldering Profile

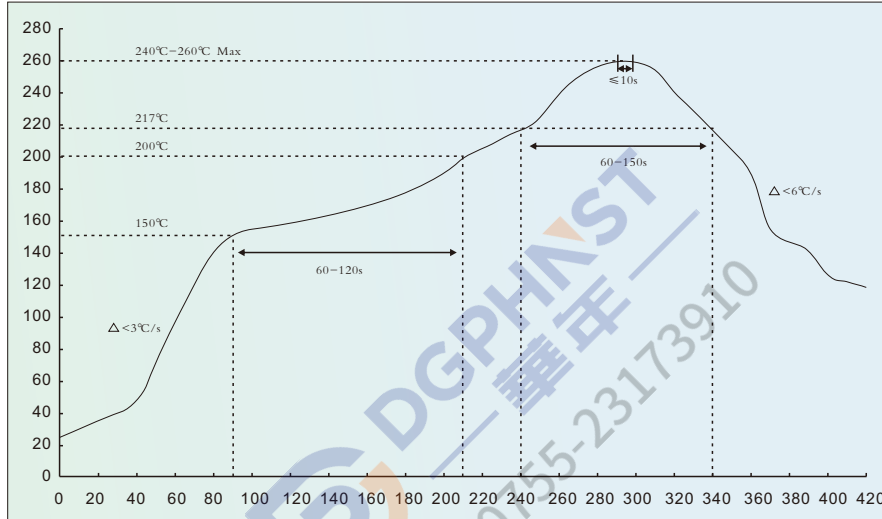

图一：无铅回流焊接温度曲线（锡银铜）
Fig1:Reflow Soldering Profile for Lead-free Solder(SnAgCu)

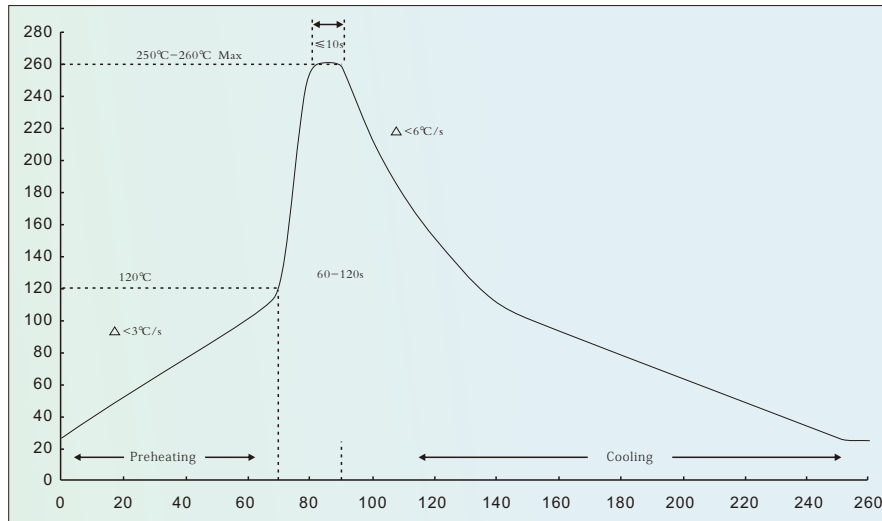

图二：波峰焊接温度曲线
Fig2:wave Soldering Profile

1.推荐的配置文件是指IPC/JEDEC J-STD-020D & IEC-60068-2-58

The recommended profiles are referring to IPC/JEDEC J-STD-020D & IEC-60068-2-58

2.贴片二极管能承受最高焊接温度为260摄氏度的最长时间是10秒，最大焊接周期的三倍；参考文献：IEC-60068-2-58

Chip diodes are able to stand maximum soldering temperature up to 260°C max for 10s, and the soldering cycles with max 3 times, referring to IEC-60068-2-58

特性 Features

- 1.SMD模式, 适合各种尺寸
SMD Chip Pattern, Available In Various Dimensions
- 2.电极表面为电镀锡, 适合波峰焊和回流焊
Matte Tin Plating Termination Layer for Reflow & Wave Soldering
- 3.产品基材为氧化铝陶瓷基板, 具有抗高热量及机械应力的能力
Aluminum Oxide Ceramic Substrate as Body, High Thermal and Mechanical Resist

应用 Application

适用于各种电子电路板
For General Purpose on Eleceronics Circuit Board

标识 Marking

标记为肖特基电压 & 电流代码 & 阴极终端
Marking as Schottky Voltage & Current Code & Cathode Terminal



电气特性, 温度=25°C Electrical Characteristics, Tamb=25°C

系列 Series		CDB140SL	CDB0530SL	CDB0230TL	CDB0230TM
尺寸代码 (英寸/毫米) Size Code(Inch/mm)		0805(2012)	0805(2012)	0603(1608)	0603(1608)
反向电压 (重复峰值) Reverse voltage (repetitive peak)	VRM	40V	30V	30V	30V
反向电压 (直流) Reverse voltage(DC)	VR	40V	20V	30V	30V
平均整流正向电流 Average rectified forward current	Io	1A	0.5A	0.2A	0.2A
正向峰值突波电流 Forward current surge peak	IFSM	5A	5A	1A	1A
界面温度 Junction Temperature	Tj	150°C	150°C	150°C	150°C
操作温度 & 储存温度范围 Operating & Storage Temperature range	Tstg	-55°C ~ +150°C			

产品结构 Product Structure

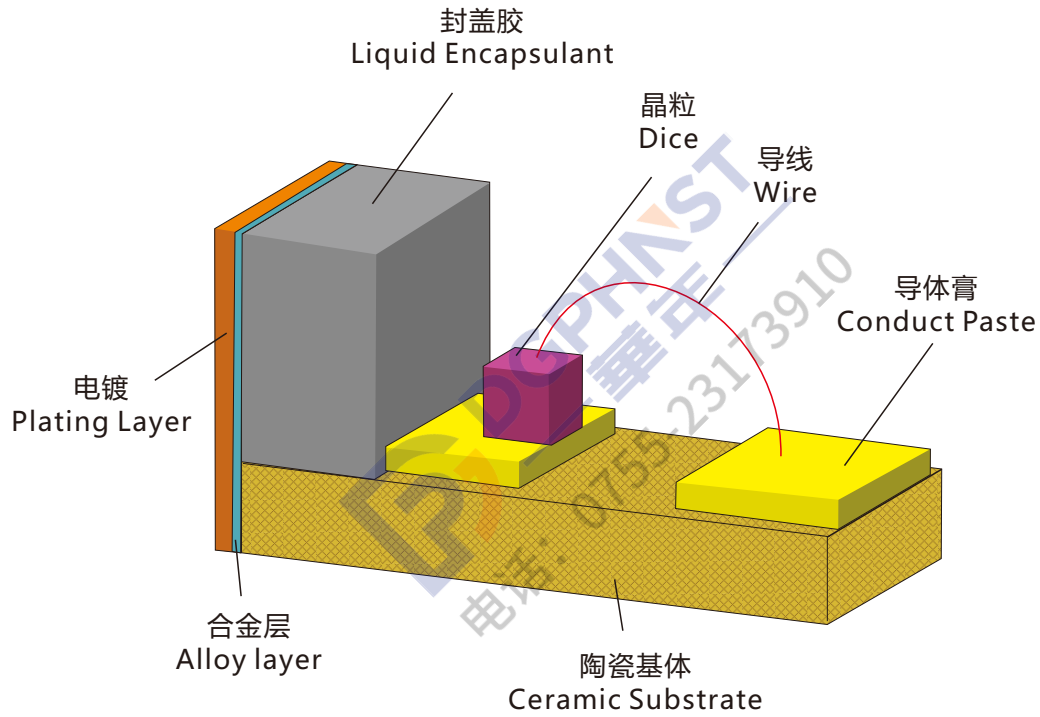

产品尺寸 Product Size

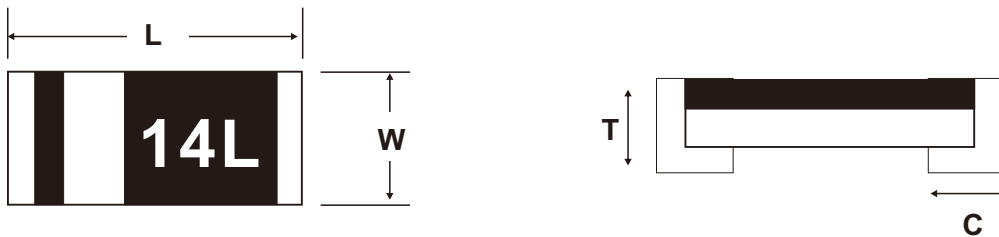

单位Unit:mm

系列Series	CDB140SL	CDB0530SL	CDB0230TL	CDB0230TM
长L	2.00±0.20	2.00±0.20	1.55±0.10	1.55±0.10
宽W	1.25±0.20	1.25±0.20	0.80±0.10	0.80±0.10
高T	0.75±0.10	0.75±0.10	0.65±0.10	0.65±0.10
背导长C	0.45±0.20	0.45±0.20	0.35±0.10	0.35±0.10

特性测试 Test Characteristic

测试项目 Test Item	测试条件 Test Condition	规格 Requirement
可焊性 Solderability	245±5°C, 2±0.5秒锡炉浸锡 Sn bath at 245±5°C for 2±0.5s	焊锡面积 > 95% > 95% area tin covered
焊接耐热 Resistance To Soldering Heat	没有物理破损, 电性在规格内 Sn bath at 260±5°C for 10±2s 260±5°C, 10±1秒	V _{F1} V _R & I _R 电性在规格内, 外观没有破损 V _{F1} V _R & I _R within spec; no mechanical damage
高温高湿 Humidity Steady State	85±3°C 85%RH 条件下保持168小时. At 85±5°C 85%RH for 168hrs	V _{F1} V _R & I _R 电性在规格内 V _{F1} V _R & I _R Within Spec
连续正向负荷寿命 Continue Forward Operating Life	IF=1.1*IO(165mA), 保持1000小时. 电性在规格内 At 25°C IF=1.1IF for 1000hrs	V _{F1} V _R & I _R 电性在规格内 V _{F1} V _R & I _R Within Spec
冷热冲击 Thermal Shock	-55±3°C/5分钟→150±3°C/5分钟; 10循环.电性在规格内 -55±5°C/5min to 150±5°C/5min for 10cycles	V _{F1} V _R & I _R 电性在规格内 V _{F1} V _R & I _R Within Spec
弯折 Bending Strength	弯曲2mm.外观没有破损, 电性在规格 Bending up to 2mm for icycle	V _{F1} V _R & I _R 电性在规格内, 外观没有破损 V _{F1} V _R & I _R Within Spec; no mechanical damage

电性数据Electrical Data

料号 Part Number	封装尺寸 Package Size	正向电压 Forward Voltage		反向电流 Resistive Current		标识 Marking
		VF	IF	IR	VR	
CDB140SL	0805	0.55V	0.7A	50uA	40V	14L
CDB0530SL	0805	0.36V	0.1A	100uA	20V	O3L
		0.47V	0.5A			
CDB0230TL	0603	0.5V	0.2A	30uA	10V	YL
CDB0230TM	0603	0.6V	0.2A	1uA	10V	YM

包装 Packing

组件的纸带及卷盘的规格如"IEC 60286-3自动封装处理

Components tape and reel specifications are referring to "IEC 60286-3 Packaging of components for automatic handling

卷盘尺寸 Reel Dimensions

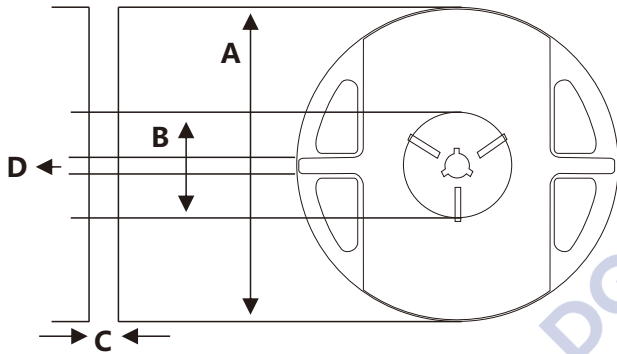

单位毫米 Unit:mm

项目 Item	尺寸 Dimension
A	178.0±1.0
B	60.0±1.0
C	9.5±0.3
D	13.0±0.3

纸带尺寸 Tape Dimensions

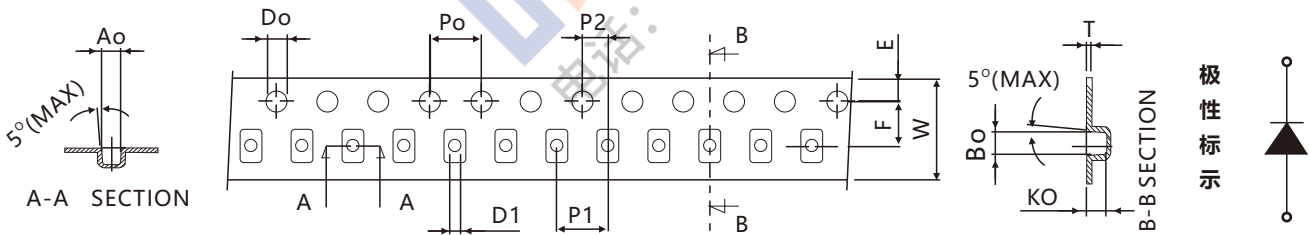

单位毫米 Unit:mm

尺寸 Dimension	0805	0603
Ao	1.65±0.10	1.10±0.05
Bo	2.35±0.10	1.90±0.05
Ko	1.50±0.10	1.05±0.05
Po	4.00±0.10	4.00±0.10
P1	4.00±0.10	4.00±0.10
P2	2.00±0.10	2.00±0.05
T	0.25±0.10	0.20±0.05
E	1.75±0.10	1.75±0.10
F	3.50±0.10	3.50±0.05
Do	1.55±0.05	1.55±0.05
D1	1.00±0.10	0.50±0.05
W	8.00±0.30	8.00±0.30
10Po	40.0±0.20	40.0±0.20

上胶带剥离 Top Tape Peeling

上胶带剥离角度165°-180°之间，从载体上剥离角度如下图所示

The top tape peeling-off angle from carrier tape is within 165°-180° during application

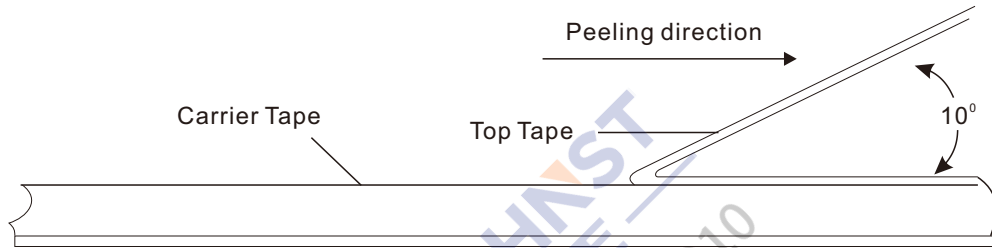

订货方式(例如 芯片肖特基二极管0805 1A 40V Low VF)

Ordering Procedure (Example Chip Schottky Diode 0805 1A 40V Low VF)

料号 (Part Number):CDB140SL

CD	B140	S	L
<p>产品系列 Product Series</p>	<p>产品类别 Product Type</p>	<p>封装尺寸 Package Size</p>	<p>特殊代码 Special Code</p>
<p>CD:贴片二极管 CD:Chip Diode</p>	<p>B肖特基二极管 B: Schottky Barrier Diode 120:1A,20V 130:1A,30V 140:1A,40V 160:1A,60V 0504:0.5A,40V 0230:0.2A,30V</p>	<p>C:SMC B:SMB A:2010 :1206 S:0805 T:0603</p>	<p>:Lead-free L:Low VF M:Low IR</p>

卷装数量 Reel Quantity

每卷5,000PCS/5,000PCS Per Reel

焊接条件 Soldering Condition

焊接条件与提示 Soldering Condition & Caution			
推荐焊接条件 Recommendee Soldering Condition (Refer to IPC/JEDEC J-STD-020D 4-1 & 5.2)			
推荐曲线条件 Recommended Profile Condition	锡铅焊接 Sn-Pb Soldering	无铅焊接 Lead free Soldering	波峰焊接 Wave Soldering
升温速度 (从预热阶段开始) Ramp-up Rate(From Pre-heat Stage)	< 3°C/s	< 3°C/s	$\Delta T < 150^{\circ}\text{C}$
预热温度与时间 Per-heat Temperature & Time	100-150°C 60-120s	150-200°C 60-120s	100-150°C 60-120s
焊接温度与时间 Soldering Temperature & Time	183°C 60-150s	217°C 60-150s	260±5°C 5±2s
最高温度 Peak Temperature	230±5°C < 260°C	240±5°C < 260°C	260±5°C
最高温度为5°C的时间 Time Within 5°C of Peak Temperatrue	10-20s	2030s	—
降温速度 Ramp-down Rate	< 6°C/s	< 6°C/s	< 6°C/s
从25°C到最高温度时间 Time 25°C to Peak Temperatrue	< 6min	< 8min	—
手工烙铁焊接条件: 350°C 3S, 避免烙铁头直接接触材料本体 Manual Soldering: Approx. 350°C for 3s, avoid solder iron tip direct touch component's body			

推荐焊盘尺寸 Recommended Soldering PAD

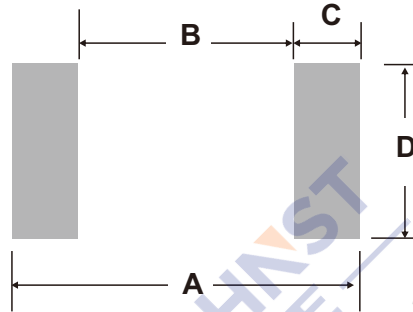

回流焊接/波峰焊接 Reflow/Wave Soldering				
产品尺寸 Product Size	尺寸/毫米 Dimension/mm			
	A	B	C	D
0805	2.6-3.4	1.2	0.7-1.1	1.2-1.4
0603	1.8-2.6	0.8	0.5-0.9	0.8-1.0

储存条件 Storage Condition

由于高温和潮湿或化学环境，产品终端的可焊性会降低。环境温度需在40°C以下，环境相对湿度需小于75%，远离化学物。
Product termination solderability can degrade due to high temperature and humidity or chemical environment. Storage condition must be in an ambient temperature of <40°C and ambient humidity of <75%RH, and free from chemical.

免责声明 Disclaimers

以下情况应避免使用这些产品：故障可能造成人身伤亡，严重的财产或环境损害，如医疗，军事，航空，太空或生命支持设备损坏等。
These products are not designed for use in applications where any failure or malfunction may result in personal injury, death or severe property or environmental damage such as medical, military, aircraft, space or life support equipments.

推荐焊接温度曲线 Reommeded Soldering Profile

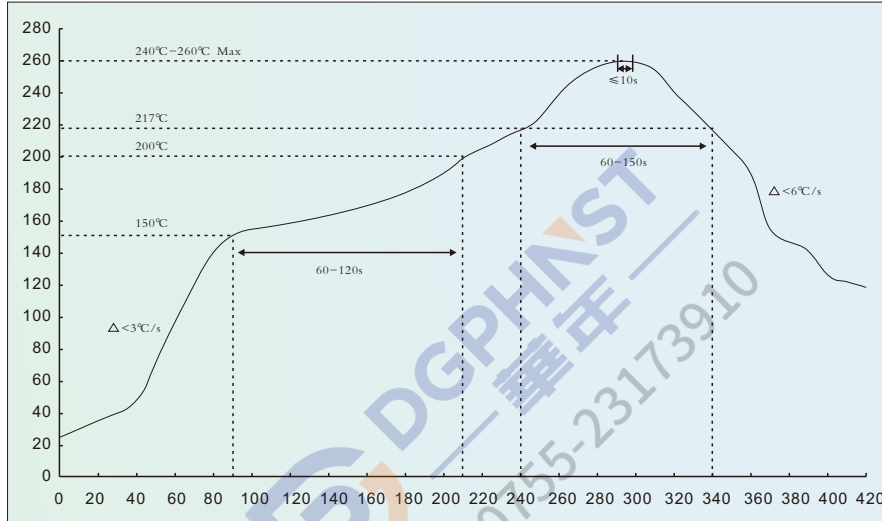

图一：无铅回流焊接温度曲线（锡银铜）
Fig1:Reflow Soldering Profile for Lead-free Solder(SnAgCu)

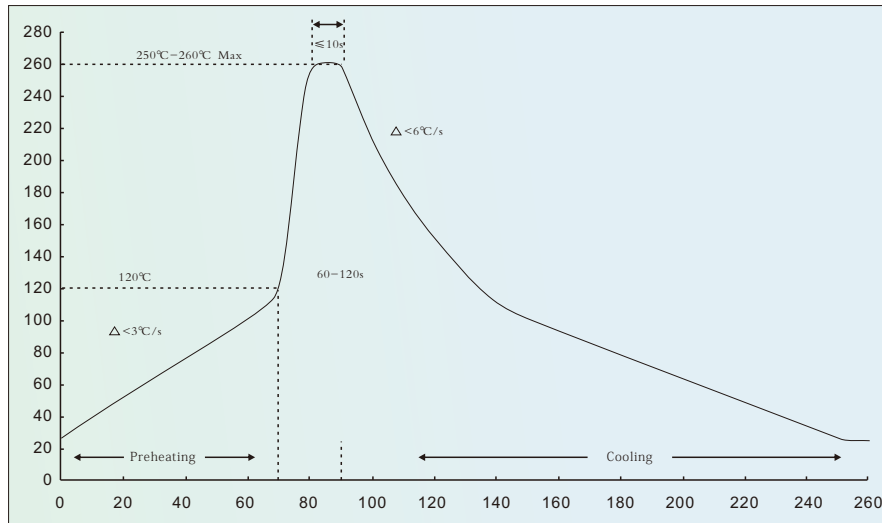

图二：波峰焊接温度曲线
Fig2:wave Soldering Profile

1.推荐的配置文件是指IPC/JEDEC J-STD-020D & IEC-60068-2-58

The recommended profiles are referring to IPC/JEDEC J-STD-020D & IEC-60068-2-58

2.贴片二极管能承受最高焊接温度为260摄氏度的最长时间是10秒，最大焊接周期的三倍；参考文献：IEC-60068-2-58

Chip diodes are able to stand maximum soldering temperature up to 260°C max for 10s, and the soldering cycles with max 3 times, referring to IEC-60068-2-58

Item 项目	Test Procedure 测试方法
Solderability 焊锡性 MIL-STD-202G METHOD208H	245±5°C, 2±0.5s solder bath dipping.Termination tinned area covered > 95% 245±5°C, 2±0.5秒锡炉浸锡, 焊锡面积 > 95%
Steam Aging Solderability 蒸汽老化可焊性 JESD22-B102-C	98±3°C, 100%RH, 4Hrs then for solderability test.Termination tinned area covered > 95% 98±3°C, 100%RH,4小时后做焊锡性测试, 焊锡面积 > 95%
Resistance to soldering heat 抗焊锡热 MIL-STD-750D METHOD2031.2	260±5°C,10±1s solder bath dipping.No mechanical damaged.Electrcal properties within spec 260±5°C,10±1秒, 脱脂棉擦拭, 外观保护层 & 字码没有破损
Hi-Pressure Steady State 高压稳定状态 JESD22-A 102-B	121°C, 16PSIG(101KPa) 100%RH for 24Hrs.Electrical properties within spec. 121°C, 16PSIG(101KPa) 100%RH for 24小时, 电性在规格内.
Thermal Shock State 冷热冲击 MIL-STD-750D METHOD1056.7	-55±3°C/5min -150±3°C/5min for 10 cycles.Electrical properties within spec. -55±3°C/5分钟 -150±3°C/5分钟; 10循环, 电性在规格内.
Temperature Cycle 温度循环 MIL-STD-750D METHOD1051.5	-55±3°C/30min -25±3°C/10min-150±3°C/30min-25±3°C/10min for 20 cycles.Electrical properties within spec. -55±3°C/30分 -25±3°C/10分-150±3°C/30分-25±3°C/10分; 20cycles(~ 2天), 电性在规格内.
Humidity Steady State 湿度稳定状态 MIL-STD-202G METHOD103B	85±3°C, 85%RH for 168Hrs.Electrical properties within spec. 85±3°C, 85%RH 条件下保持168小时, 电性在规格内.
Continue Forward Operating life 连续操作寿命 MIL-STD-750D METHOD1026.5	1F=1.1*IO.load for 1000Hrs.Electrical properties within spec. 1F=1.1*IO,保持1000小时, 电性在规格内.
Inermittent Forward Operating life 间歇操作寿命 MIL-STD-750D METHOD1036.3	1F=1.5*IO.ON 5 min&OFF 5 min,load for 1000cyc.Electrical properties within spec. 1F=1.5*IO,开启5分钟, 关闭5分钟, 循环1000次, 电性在规格内.
Hi-Temperature Reverse Bias 高温反向偏压 MIL-STD-750D METHOD1038.4	T=Ti(MAX),VR=80% RATED VR,load for 1000Hrs.Electrical properties within spec. T=Ti(MAX),VR=80%VR 条件下, 保持1000小时, 电性在规格内.
Hi-Temperature Storage Life 高温储存寿命测试 MIL-STD-750D METHOD1031.5	Ta=TstgMAX,T=168/1000hrs Electrical properties within spec. Ta=TstgMAX,T=168/1000小时, 电性在规格内.



丽智电子（南通）有限公司 LIZ Electronics (Nantong) Co., Ltd.

江苏省南通市通州区康富路789号
No.789,Kangfu Rd.,Nantong,Jiangsu,China
Tel:+86-513-68856666

丽智电子（昆山）有限公司 LIZ Electronics(Kunshan)Co.,Ltd.

江苏省昆山市汉浦路989号
No.989,Hanpu Rd.,Kunshan,Jiangsu,China
Tel:+86-512-82690531

E-mail:Sales.ks@lizgroup.com
Website:www.lizgroup.com

LIZ Electronics.ALL Rights are Reserved
Information Presented Subject To Change Without Notice
July 2022