

AVX Tantalum and Niobium Oxide Capacitors

DGPHYST
E-MAIL: 0755-23117391@163.COM



Version 13.6

AVX
A KYOCERA GROUP COMPANY

SECTION 1:	SURFACE MOUNT COMMERCIAL TANTALUM	
	Introduction	2-3
	Tantalum and Niobium Road Map	4-5
General	TAJ Series – Standard Tantalum	6-10
	TAJ Automotive Series – Standard Tantalum – Automotive Product Range	11-13
	F93 Series – Resin-Molded Chip, Standard Tantalum J-Lead	14-15
	F93-AJ6 – Resin-Molded Chip – Automotive Product Range	16-17
	TAC Series – Standard TACmicrochip®	18-20
	F95 Series – Standard Conformal Coated Chip	21-22
Low Profile	TAJ Series – Low Profile	23-27
	F92 Series – Resin-Molded Chip, Low Profile J-Lead	28-29
	TAC Series – Low Profile TACmicrochip®	30-31
HiCV	TLJ Series – Tantalum Solid Electrolytic Chip Caps High CV Consumer Series	32-35
	TLC Series – Tantalum Solid Electrolytic Chip Caps Consumer Series	36-38
	TLN Series – Tantalum Solid Electrolytic Chip Caps Undertab Series	39-40
	TLN PulseCap™ Series – High Capacitance Tantalum Solid Electrolytic Chip Caps Undertab Series	41-42
	F98 Series – Resin-Molded Chip, High CV Frameless®	43
	F72/F75 Series – Low Profile and HiCV Conformal Coated Chip	44-45
Low ESR	TPS Series – Low ESR	46-56
	TPS Automotive Series – Low ESR – Automotive Product Range	57-61
	F91 Series – Low ESR, Resin-Molded Chip J-Lead	62
	TPM Series – Multianode, Tantalum Ultra Low ESR	63-65
	TPC Series – Low ESR TACmicrochip®	66-68
Polymer	TCJ Series – Tantalum Solid Electrolytic Chip Caps w/Conductive Polymer Electrode	69-74
	TCM Series – Tantalum Solid Electrolytic Chip Caps/Conductive Polymer Multianode	75-76
	TCN Series – Tantalum Solid Electrolytic Chip Caps Undertab Series w/Conductive Polymer Electrode	77-78
	F38 Series – Conductive Polymer, Miniature, Frameless®	79
Performance	TRJ Series – Professional Tantalum	80-85
	F97 Series – Resin-Molded Chip, Improved Reliability J-Lead	86-87
	TRM Series – Professional Multianode	88-90
	THJ Series – High Temperature (up to 175°C)	91-93
	THJ Series with Extension to 200°C	94-95
	TAW Series – Fused Tantalum	96-97
	AUDIO F95 Series – Conformal Coated Chip Optimized for Audio Applications	98-99
SECTION 2:	NIOBIUM OXIDE - OxiCap®	
	NOJ Series – Standard OxiCap®	100-103
	NOJ Series – Low Profile	104-106
	NLJ Series – High CV Consumer Series	107-108
	NOS Series – Low ESR OxiCap®	109-112
	NOM Series – Low ESR Multianodes	113-114
SECTION 3:	LEADED TANTALUM	
	Introduction	115
	Dipped Radial Capacitors	115
	Dipped Radial – TAP/TEP Series Wire Form Outline	116
	TAP Series	117-119
	TEP Series	120-122
	TAP/TEP Series Tape & Reel	123-124
SECTION 4:	TECHNICAL SUMMARY AND APPLICATION GUIDELINES	
	Introduction	125-126
	Section 1: Electrical Characteristics and Explanation of Terms	127-131
	Section 2: A.C. Operation, Ripple Voltage and Ripple Current	132-134
	Section 3: Reliability and Calculation of Failure Rate	135-137
	Section 4: Application Guidelines for Tantalum and OxiCap® Capacitors	138
	Section 5: Terminations	139
	Section 6: Mechanical and Thermal Properties of Capacitors	140-141
	Section 7: Epoxy Flammability	141
	Section 8: Qualification Approval Status	141
	Product Safety and Environmental Information Data	142-145
	Tantalum & Niobium Oxide Capacitors (excluding F-Series) – Tape & Reel Packaging	146-149
	F-Series Capacitors – Tape & Reel Packaging	150
	Tantalum & Niobium Oxide Capacitors – Marking	151
	TAP/TEP TECHNICAL SUMMARY AND APPLICATION GUIDELINES	
	Section 1: Electrical Characteristics and Explanation of Terms	152-155
	Section 2: A.C. Operation, Ripple Voltage and Ripple Current	156
	Section 3: Reliability and Calculation of Failure Rate	157-159
	Section 4: Application Guidelines for Tantalum Capacitors	160
	Questions and Answers	161-164
SOFTWARE TOOLS		165
PRODUCT LISTING		166
RANGE OF SAMPLE KITS		167

Section 1: Introduction



AVX Tantalum

APPLICATIONS

		
Low ESR	Automotive Range	Low ESR
Low Profile Case	High Reliability	World's Smallest Tantalum
Low Failure Rate	Temperature Stability	0402 Available
High Volumetric Efficiency	ISO/TS 16949 Plant Approved	High Volumetric Efficiency
Temperature Stability	Up to 175°C (200°C)	Low Profile Versions
Stable over Time	AEC-Q200 Approval	

QUALITY STATEMENTS

AVX's focus is CUSTOMER satisfaction - customer satisfaction in the broadest sense: product quality, technical support, product availability - all at a competitive price.

In pursuance of the established goals of AVX corporation, it is the stated objective of AVX Tantalum to supply our customers with a world class service in the manufacture and supply of electronic components, while maintaining a positive return on investment.

This world class service shall be defined as consistently supplying product and services of the highest quality and reliability encompassing all aspects of the customer supply chain.

In addition, any new or changed products, processes or services will be qualified to established standards of quality and reliability.

The objectives and guidelines listed above shall be achieved by the following codes of practice:

1. Continual objective evaluation of customer needs and expectations for the future and the leverage of all AVX resources to meet this challenge.

2. Continually fostering and promoting a culture of continuous improvement through ongoing training and empowered participation of employees at all levels of the company.

3. Continuous Process Improvement using sound engineering principles to enhance existing equipment, material and processes. This includes the application of the science of S.P.C. focused on improving the Process Capability Index, Cpk.

The Tantalum division has plants approved to ISO 9001:2008 and ISO/TS 16949:2009 (Automotive Quality System Requirements) with the intention that all facilities world-wide will adopt this as the quality standard.

Dedicated series of tantalum and niobium oxide capacitors meets requirements of AEC-Q200.

The Tantalum division has plants approved to ISO 14001:2004 with the intention that all facilities world-wide will adopt this as the quality standard.



Introduction



AVX Tantalum

AVX Paignton UK is the Divisional Headquarters for the Tantalum division which has manufacturing locations in Biddeford in Maine, USA, Lanskroun in the Czech Republic and San Salvador, in El Salvador. AVX is also pleased to add manufacturing facilities in Adogawa in Japan and Tianjin in China through the recent acquisition of the Tantalum Division of Nichicon Corporation.

This division manufactures tantalum and niobium oxide capacitors. Tantalum is an element extracted from ores found alongside tin and niobium deposits; the major sources of supply are Brazil, Africa and Australasia.

Since December 1st, 2011, AVX has exclusively sourced the tantalum powder and wire used to manufacture its tantalum

capacitors from smelters whose compliance with the Electronic Industry Code of Conduct (EICC) and the Global e-Sustainability Initiative (GeSI) Conflict-Free Smelter program has been verified.

Niobium oxide is a ceramic material that can be processed to the same powder form as traditional tantalum capacitors and manufactured in an identical process.

AVX is No.1 Tantalum capacitor manufacturer with widest range of capacitors from smallest to large case sizes, from consumer to automotive, medical and aerospace level applications. AVX has a leading market position in all world regions. Call us first - **AVX your global partner.**

TECHNOLOGY TRENDS

The amount of capacitance possible with a tantalum capacitor is directly related to the type of tantalum powder used to manufacture the anode.

The following graph shows how the (capacitance) x (voltage) per gram (CV/g) has steadily increased over time, thus allowing the production of larger and larger capacitances with the same physical volume. CV/g is the measure used to define the volumetric efficiency of a powder, a higher CV/g means a higher capacitance from the same volume.

These powder improvements have been achieved through close development with the material suppliers.

AVX Tantalum is committed to driving the available technology forward as is clearly demonstrated by extended ratings continually being developed, and technologies such as TACmicrochip®, OxiCap® and unique Tantalum polymer technology.

If you have any specific requirements, please contact your local AVX sales office for details on how AVX Tantalum can assist you in addressing your future requirements.

WORKING WITH THE CUSTOMER - ONE STOP SHOPPING

In line with our desire to be the number one supplier in the world for passive and interconnection components, AVX is applying continuous improvement policy and development of new innovative technologies.

It is not good enough to market the best products; the customer must have access to a service system which suits his needs and benefits business.

The AVX 'one stop shopping' concept is already beneficial in meeting the needs of major OEMs while worldwide partnerships with only the premier division of distributors aids the smaller user.

Helping to market and support our customers across the breadth and depth of our electronic component line card are

a dedicated team of sales engineers, applications engineers and product marketing managers.

Total quality starts and finishes with our commitment to customer service. Where cost and quality are perceived as given quantities AVX's first in class service invariably places us in the top rank of any preferred supplier list.

Facilities are equipped with instant worldwide DP and telecommunication links connected to every sales and production site worldwide. That ensures our customers' delivery requirements are consistently met wherever in the world they may be.

Tantalum Powder CV/g

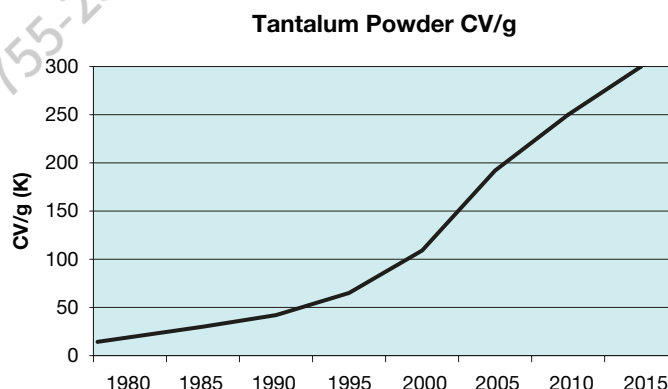

*Niobium Oxide Capacitors are manufactured and sold under patent license from Cabot Corporation, Boyertown, Pennsylvania U.S.A.

Tantalum and Niobium Road Map



	Tantalum SMD Chip									
	Standard	Low ESR	Multianodes	Polymer	PulseCap	High CV	CWR 09, 19, 29*		Fused	Modules
							Standard	Low ESR		
Commercial	TAJ	TPS Low ESR	TPM Ultra Low ESR	TCJ	TLN PulseCap	TLJ			TAW	
	TAJ Low Profile			TCM Multianode		TLN Undertab				
	F93			F91		TCN Undertab				
	F92 Low Profile	F38				F72/F75 Conformal				
	F95 Conformal									
Professional	TAJ Automotive	TPS Automotive	TRM	TCB						
	F93-AJ6	TRJ Low ESR								
	TRJ									
	F97									
High-Temp	THJ 175/200°C									
CECC	TAJ CECC* 30801-011 30801-005									
COTS+*	TBJ	TBJ Low ESR	TBM Ultra Low ESR	TCB			TAZ	TAZ		TCP Ultra Low ESR
DSCC*	DSCC 95158	DSCC 95158								DSCC 09009
	DSCC 07016	DSCC 07016								
MIL-PRF*	CWR11						CWR09	CWR29		
							CWR19 High CV			
Space Level*	TAJ ESCC ESCC 3012/001	TBJ SRC9000	TBM SRC9000				TAZ SRC9000	TAZ SRC9000		TCP SRC9000
		TES ESCC 3012-004	TES ESCC 3012-004				CWR 'T' Level	CWR 'T' Level		
Medical*	TMJ	TMJ					TAZ HRC5000	TAZ HRC5000		TCP HRC5000

*See High Reliability Tantalum Catalog

NOTE: For specific requirements please contact manufacturer

Under development

SMD Tantalum Capacitors Series Guide per Construction						
Construction Type / Purpose	General	Low profile	HiCV	Low ESR	Polymer	Performance
J-lead Tantalum	TAJ	TAJ-LP	TLJ	TPS	TCJ	TRJ
				TPM		TRM
	F93	F92		F91	TCM	THJ
						THJ+
						F97
					TAW	
					TMJ	
J-lead NbO	NOJ	NOJ-LP	NLJ	NOS NOM		
TACmicrochip®	TAC	TAC-LP	TLC	TPC		TMC
Undertab, Frameless			TLN		TCN	
			TLN PulseCap			
			F98			
Conformal	F95		F72/F75			AUDIO F95



Tantalum and Niobium Road Map



	TACmicrochip®			Leaded			Hermetic Sealed*		Niobium OxiCap®		
	High CV	Standard	Low ESR	Resin Dipped	Wet*	Wet** Modules	Polymer	MnO ₂	Standard	Low ESR	Multianode
Commercial	TLC	TAC	TPC	TAP/TEP Radial					NOJ NLJ	NOS	NOM
Professional							TCH	THH	NOJ	NOS	NOM
High-Temp					TWA-Y 200°C TWC-Y 200°C			THH 230°C			
CECC				TAP CECC 30201-032	TWA-E TWC-E						
COTS+*		TBC			TWA-S TWC-S	TWM	TCH	THH		NBS	NBM
DSCC*					DSCC 93026						
MIL-PRF*		CWR15			M39006						
Space Level*		TBC SRC9000			SRW 9000	TWM	TCH 3012-005				
Medical*		TBC HRC5000 TBC HRC6000 TMC									

*See High Reliability Tantalum Catalog

NOTE: For specific requirements please contact manufacturer

Under development

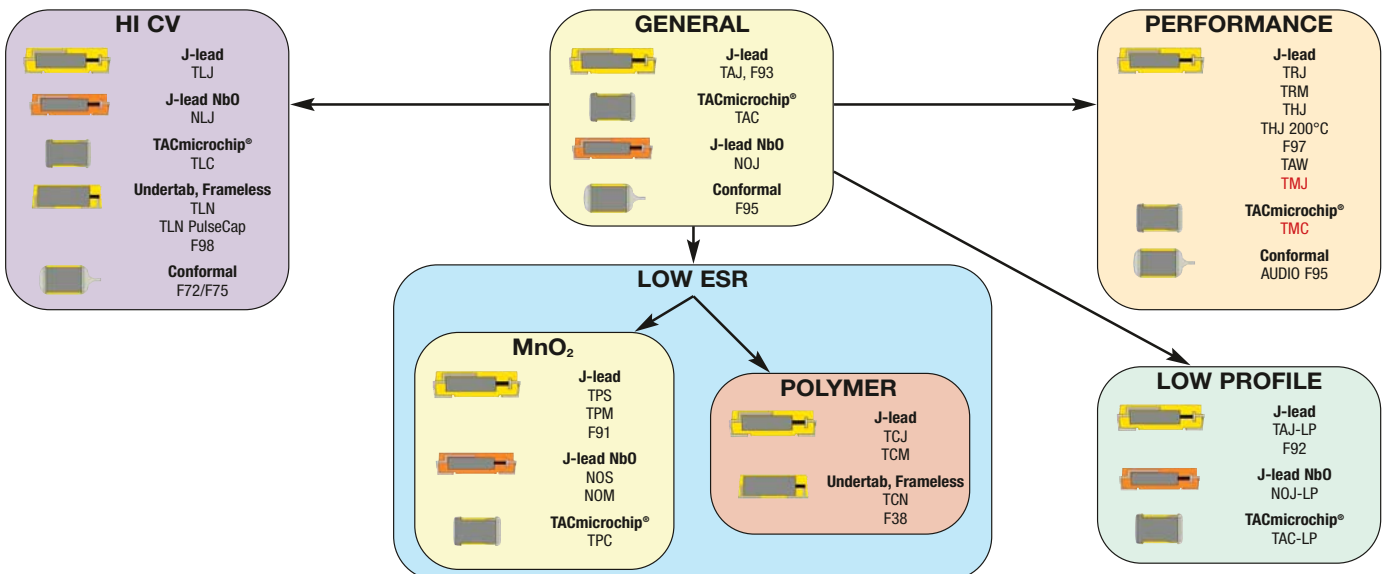

TAJ Series

Standard Tantalum



- General purpose SMT chip tantalum series
- 7 case sizes available
- Low profile options available
- CV range: 0.10-2200µF / 2.5-50V



SnPb termination option is not RoHS compliant.

CASE DIMENSIONS: millimeters (inches)

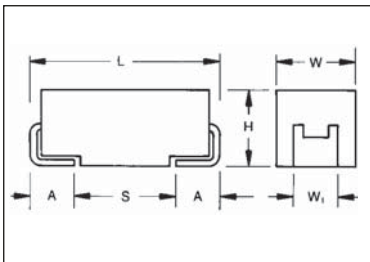

For part marking see page 151

Code	EIA Code	EIA Metric	L±0.20 (0.008)	W+0.20 (0.008) -0.10 (0.004)	H+0.20 (0.008) -0.10 (0.004)	W ₁ ±0.20 (0.008)	A+0.30 (0.012) -0.20 (0.008)	S Min.
A	1206	3216-18	3.20 (0.126)	1.60 (0.063)	1.60 (0.063)	1.20 (0.047)	0.80 (0.031)	1.10 (0.043)
B	1210	3528-21	3.50 (0.138)	2.80 (0.110)	1.90 (0.075)	2.20 (0.087)	0.80 (0.031)	1.40 (0.055)
C	2312	6032-28	6.00 (0.236)	3.20 (0.126)	2.60 (0.102)	2.20 (0.087)	1.30 (0.051)	2.90 (0.114)
D	2917	7343-31	7.30 (0.287)	4.30 (0.169)	2.90 (0.114)	2.40 (0.094)	1.30 (0.051)	4.40 (0.173)
E	2917	7343-43	7.30 (0.287)	4.30 (0.169)	4.10 (0.162)	2.40 (0.094)	1.30 (0.051)	4.40 (0.173)
U	2924	7361-43	7.30 (0.287)	6.10 (0.240)	4.10 (0.162)	3.10 (0.120)	1.30 (0.051)	4.40 (0.173)
V	2924	7361-38	7.30 (0.287)	6.10 (0.240)	3.55 (0.140)	3.10 (0.120)	1.30 (0.051)	4.40 (0.173)

W₁ dimension applies to the termination width for A dimensional area only.

HOW TO ORDER

TAJ	C	106	M	035	R	NJ	-
Type	Case Size See table above	Capacitance Code pF code: 1st two digits represent significant figures 3rd digit represents multiplier (number of zeros to follow)	Tolerance K=±10% M=±20%	Rated DC Voltage 002=2.5Vdc 004=4Vdc 006=6.3Vdc 010=10Vdc 016=16Vdc 020=20Vdc 025=25Vdc 035=35Vdc 050=50Vdc	Packaging R = Pure Tin 7" Reel S = Pure Tin 13" Reel A = Gold Plating 7" Reel B = Gold Plating 13" Reel H = Tin Lead 7" Reel (Contact Manufacturer) K = Tin Lead 13" Reel (Contact Manufacturer) H, K = Non RoHS	Specification Suffix NJ = Standard Suffix	Additional characters may be added for special requirements V = Dry pack Option (selected codes only)

TECHNICAL SPECIFICATIONS

Technical Data:	All technical data relate to an ambient temperature of +25°C										
Capacitance Range:	0.10 µF to 2200 µF										
Capacitance Tolerance:	±10%; ±20%										
Rated Voltage (V _R)	≤ +85°C:	2.5	4	6.3	10	16	20	25	35	50	
Category Voltage (V _C)	≤ +125°C:	1.7	2.7	4	7	10	13	17	23	33	
Surge Voltage (V _S)	≤ +85°C:	3.3	5.2	8	13	20	26	32	46	65	
Surge Voltage (V _S)	≤ +125°C:	2.2	3.4	5	8	13	16	20	28	40	
Temperature Range:	-55°C to +125°C										
Reliability:	1% per 1000 hours at 85°C, V _R with 0.1Ω/V series impedance, 60% confidence level										
Qualification:	CECC 30801 - 005 issue 2 EIA 535BAAC										
Termination Finished:	Sn Plating (standard), Gold and SnPb Plating upon request For AEC-Q200 availability, please contact AVX										



Standard Tantalum

CAPACITANCE AND RATED VOLTAGE, VR (VOLTAGE CODE) RANGE (LETTER DENOTES CASE SIZE)

Capacitance		Rated voltage DC (V _R) to 85°C								
µF	Code	2.5V (e)	4V (G)	6.3V (J)	10V (A)	16V (C)	20V (D)	25V (E)	35V (V)	50V (T)
0.10	104								A	A
0.15	154								A	A/B
0.22	224								A	A/B
0.33	334							A	A	A/B
0.47	474						A	A	A/B	A/B/C
0.68	684						A	A	A/B	A/B/C
1.0	105					A	A	A	A/B	A ^(M) /B/C
1.5	155				A	A	A	A/B	A/B/C	B/C/D
2.2	225			A	A	A/B	A/B	A/B	A/B/C	B/C/D
3.3	335			A	A	A/B	A/B	A/B/C	A/B/C	C/D
4.7	475		A	A	A/B	A/B	A/B/C	A/B/C	B/C/D	C/D
6.8	685		A	A/B	A/B	A/B/C	A/B/C	B/C	C/D	C/D
10	106		A	A/B	A/B/C	A/B/C	A ^(M) /B/C	B/C/D	C/D/E	D/E/V
15	156		A/B	A/B	A/B/C	A ^(M) /B/C	B/C/D	C/D	C/D	D/E/V
22	226		A	A/B/C	A/B/C	B/C/D	B/C/D	C/D	D/E	V
33	336	A	A/B	A/B/C	A/B/C/D	B/C/D	C/D	C/D	D/E	D/E/V
47	476	A	A/B	A/B/C/D	B/C/D	C/D	C/D/E	D/E	D/E	E/V
68	686	A	A/B/C	B/C/D	B/C/D	C/D	C ^(M) /D/E	E/V	E/V	V
100	107	A/B	A/B/C	B/C/D	B ^(M) /C/D/E	C/D/E	D/E/V	E ^(M) /V		
150	157	B	B/C	B ^(M) /C/D	C/D/E	D/E/V	E/V	V ^(M)		
220	227	B/D	B ^(M) /C/D	C/D/E	C/D/E	E/V				
330	337	D	C/D/E	C/D/E	D/E/V	E ^(M)				
470	477	C/D	C/D/E	D/E/V	E/U/V					
680	687	C/D/E	D/E	E/V						
1000	108	D ^(M) /E	D/E/V	E ^(M) /V ^(M)						
1500	158	D/E/V ^(M)	E/V ^(M)							
2200	228	V ^(M)								

Not recommended for new designs, higher voltage or smaller case size substitution are offered.

Released codes ^(M tolerance only)

Engineering samples - please contact manufacturer

*Codes under development - subject to change

Note: Voltage ratings are minimum values. AVX reserves the right to supply higher ratings in the same case size, to the same reliability standards.

TAJ Series

Standard Tantalum



RATINGS & PART NUMBER REFERENCE

AVX Part No.	Case Size	Cap (µF)	Rated Voltage (V)	DCL (µA) Max.	DF % Max.	ESR Max. (Ω) @100kHz	MSL
2.5 Volt @ 85°C (1.7 Volt @ 125°C)							
TAJA336*002#NJ	A	33	2.5	0.8	8	1.7	1
TAJA476*002#NJ	A	47	2.5	0.9	6	3	1
TAJA686*002#NJ	A	68	2.5	1.4	8	1.5	1
TAJA107*002#NJ	A	100	2.5	2.5	30	1.4	1
TAJB107*002#NJ	B	100	2.5	2.5	8	1.4	1
TAJB157*002#NJ	B	150	2.5	3	10	1.6	1
TAJB227*002#NJ	B	220	2.5	4.4	16	1.6	1
TAJD227*002#NJ	D	220	2.5	5.5	8	0.3	1
TAJD337*002#NJ	D	330	2.5	8.2	8	0.3	1
TAJC477*002#NJ	C	470	2.5	9.4	12	0.2	1
TAJD477*002#NJ	D	470	2.5	11.6	8	0.2	1
TAJC687*002#NJ	C	680	2.5	17.0	18	0.2	1
TAJD687*002#NJ	D	680	2.5	17	16	0.2	1
TAJE687*002#NJ	E	680	2.5	17	10	0.2	1 ¹⁾
TAJD108M002#NJ	D	1000	2.5	25	20	0.2	1
TAJE108*002#NJ	E	1000	2.5	20	14	0.4	1 ¹⁾
TAJD158*002#NJ	D	1500	2.5	37.5	60	0.2	1
TAJE158*002#NJ	E	1500	2.5	37	20	0.2	1 ¹⁾
TAJV158M002#NJ	V	1500	2.5	30	20	0.2	1 ¹⁾
TAJV228M002#NJ	V	2200	2.5	55	50	0.2	1 ¹⁾
4 Volt @ 85°C (2.7 Volt @ 125°C)							
TAJA336*004#NJ	A	33	4	1.3	6	3	1
TAJA476*004#NJ	A	47	4	1.9	8	2.6	1
TAJA686*004#NJ	A	68	4	2.7	10	1.5	1
TAJB686*004#NJ	B	68	4	2.7	6	1.8	1
TAJA107*004#NJ	A	100	4	4	30	1.4	1
TAJB107*004#NJ	B	100	4	4	8	0.9	1
TAJB157*004#NJ	B	150	4	6	10	1.5	1
TAJC157*004#NJ	C	150	4	6	6	0.3	1
TAJB227M004#NJ	B	220	4	8.8	12	1.1	1
TAJC227*004#NJ	C	220	4	8.8	8	1.2	1
TAJD227*004#NJ	D	220	4	8.8	8	0.9	1
TAJC337*004#NJ	C	330	4	13.2	8	0.3	1
TAJD337*004#NJ	D	330	4	13.2	8	0.9	1
TAJC477*004#NJ	C	470	4	18.8	14	0.3	1
TAJD477*004#NJ	D	470	4	18.8	12	0.9	1
TAJE477*004#NJ	E	470	4	18.8	10	0.5	1 ¹⁾
TAJD687*004#NJ	D	680	4	27.2	14	0.5	1
TAJE687*004#NJ	E	680	4	27.2	14	0.9	1 ¹⁾
TAJD108*004#NJ	D	1000	4	40	60	0.2	1
TAJE108*004#NJ	E	1000	4	40	14	0.4	1 ¹⁾
TAJV108*004#NJ	V	1000	4	40	16	0.2	1 ¹⁾
TAJE158*004#NJ	E	1500	4	60	30	0.2	1 ¹⁾
TAJV158M004#NJ	V	1500	4	60	30	0.2	1 ¹⁾
6.3 Volt @ 85°C (4 Volt @ 125°C)							
TAJA106*006#NJ	A	10	6.3	0.6	6	4	1
TAJA156*006#NJ	A	15	6.3	0.9	6	3.5	1
TAJA226*006#NJ	A	22	6.3	1.4	6	3	1
TAJA336*006#NJ	A	33	6.3	2.1	8	2.2	1
TAJA476*006#NJ	A	47	6.3	2.8	10	1.6	1
TAJB476*006#NJ	B	47	6.3	3	6	2	1
TAJC476*006#NJ	C	47	6.3	3	6	1.6	1
TAJB686*006#NJ	B	68	6.3	4	8	0.9	1
TAJC686*006#NJ	C	68	6.3	4.3	6	1.5	1
TAJB107*006#NJ	B	100	6.3	6.3	10	1.7	1
TAJC107*006#NJ	C	100	6.3	6.3	6	0.9	1
TAJB157M006#NJ	B	150	6.3	9.5	10	1.2	1
TAJC157*006#NJ	C	150	6.3	9.5	6	1.3	1

AVX Part No.	Case Size	Cap (µF)	Rated Voltage (V)	DCL (µA) Max.	DF % Max.	ESR Max. (Ω) @100kHz	MSL
TAJD157*006#NJ	D	150	6.3	9.5	6	0.9	1
TAJC227*006#NJ	C	220	6.3	13.9	8	1.2	1
TAJD227*006#NJ	D	220	6.3	13.9	8	0.4	1
TAJE227*006#NJ	E	220	6.3	13.9	8	0.4	1 ¹⁾
TAJC337*006#NJ	C	330	6.3	19.8	12	0.5	1
TAJD337*006#NJ	D	330	6.3	20.8	8	0.4	1
TAJE337*006#NJ	E	330	6.3	20.8	8	0.4	1 ¹⁾
TAJD477*006#NJ	D	470	6.3	28	12	0.4	1
TAJE477*006#NJ	E	470	6.3	28	10	0.4	1 ¹⁾
TAJV477*006#NJ	V	470	6.3	28	10	0.4	1 ¹⁾
TAJE687*006#NJ	E	680	6.3	42.8	10	0.5	1 ¹⁾
TAJV687*006#NJ	V	680	6.3	42.8	10	0.5	1 ¹⁾
TAJE108M006#NJ	E	1000	6.3	60	20	0.2	1 ¹⁾
TAJV108M006#NJ	V	1000	6.3	60	16	0.2	1 ¹⁾
10 Volt @ 85°C (7 Volt @ 125°C)							
TAJA475*010#NJ	A	4.7	10	0.5	6	5	1
TAJA685*010#NJ	A	6.8	10	0.7	6	4	1
TAJA106*010#NJ	A	10	10	1	6	3	1
TAJA156*010#NJ	A	15	10	1.5	6	3.2	1
TAJB156*010#NJ	B	15	10	1.5	6	2.8	1
TAJA226*010#NJ	A	22	10	2.2	8	3	1
TAJB226*010#NJ	B	22	10	2.2	6	2.4	1
TAJA336*010#NJ	A	33	10	3.3	8	1.7	1
TAJB336*010#NJ	B	33	10	3.3	6	1.8	1
TAJC336*010#NJ	C	33	10	3.3	6	1.6	1
TAJB476*010#NJ	B	47	10	4.7	8	1	1
TAJC476*010#NJ	C	47	10	4.7	6	1.2	1
TAJB686*010#NJ	B	68	10	6.8	6	1.4	1
TAJC686*010#NJ	C	68	10	6.8	6	1.3	1
TAJB107M010#NJ	B	100	10	10	8	1.4	1
TAJC107*010#NJ	C	100	10	10	8	1.2	1
TAJD107*010#NJ	D	100	10	10	6	0.9	1
TAJC157*010#NJ	C	150	10	15	8	0.9	1
TAJD157*010#NJ	D	150	10	15	8	0.9	1
TAJE157*010#NJ	E	150	10	15	8	0.9	1 ¹⁾
TAJC227*010#NJ	C	220	10	22	16	0.5	1
TAJD227*010#NJ	D	220	10	22	8	0.5	1
TAJE227*010#NJ	E	220	10	22	8	0.5	1 ¹⁾
TAJD337*010#NJ	D	330	10	33	8	0.9	1
TAJE337*010#NJ	E	330	10	33	8	0.9	1 ¹⁾
TAJV337*010#NJ	V	330	10	33	10	0.9	1 ¹⁾
TAJE477*010#NJ	E	470	10	47	10	0.5	1 ¹⁾
TAJU477*010RNJ	U	470	10	47	12	0.5	1 ¹⁾
TAJV477*010#NJ	V	470	10	47	10	0.5	1 ¹⁾
16 Volt @ 85°C (10 Volt @ 125°C)							
TAJA225*016#NJ	A	2.2	16	0.5	6	6.5	1
TAJA335*016#NJ	A	3.3	16	0.5	6	5	1
TAJB335*016#NJ	B	3.3	16	0.5	6	4.5	1
TAJA475*016#NJ	A	4.7	16	0.8	6	4	1
TAJB475*016#NJ	B	4.7	16	0.8	6	3.5	1
TAJA685*016#NJ	A	6.8	16	1.1	6	3.5	1
TAJB685*016#NJ	B	6.8	16	1.1	6	2.5	1
TAJA106*016#NJ	A	10	16	1.6	6	3	1
TAJB106*016#NJ	B	10	16	1.6	6	2.8	1
TAJC106*016#NJ	C	10	16	1.6	6	2	1
TAJA156M016#NJ	A	15	16	2.4	6	2	1
TAJB156*016#NJ	B	15	16	2.4	6	2.5	1
TAJC156*016#NJ	C	15	16	2.4	6	1.8	1
TAJB226*016#NJ	B	22	16	3.5	6	2.3	1
TAJC226*016#NJ	C	22	16	3.5	6	1	1

¹⁾ Dry pack option (see How to order) recommended for reduction of stress during soldering. Dry pack parts should be treated as MSL 3.

Moisture Sensitivity Level (MSL) is defined according to J-STD-020.

For AEC-Q200 availability, please contact AVX.

All technical data relates to an ambient temperature of +25°C. Capacitance and DF are measured at 120Hz, 0.5V RMS with a maximum DC bias of 2.2 volts.

DCL is measured at rated voltage after 5 minutes.

For typical weight and composition see page 144.

NOTE: AVX reserves the right to supply a higher voltage rating or tighter tolerance part in the same case size, to the same reliability standards.



Standard Tantalum

RATINGS & PART NUMBER REFERENCE

AVX Part No.	Case Size	Cap (µF)	Rated Voltage (V)	DCL (µA) Max.	DF % Max.	ESR Max. (Ω) @100kHz	MSL
TAJD226*016#NJ	D	22	16	3.5	6	1.1	1
TAJB336*016#NJ	B	33	16	5.3	8	2.1	1
TAJC336*016#NJ	C	33	16	5.3	6	1.5	1
TAJD336*016#NJ	D	33	16	5.3	6	0.9	1
TAJC476*016#NJ	C	47	16	7.5	6	0.5	1
TAJD476*016#NJ	D	47	16	7.5	6	0.9	1
TAJC686*016#NJ	C	68	16	10.9	6	1.3	1
TAJD686*016#NJ	D	68	16	10.9	6	0.9	1
TAJC107*016#NJ	C	100	16	16	8	1	1
TAJD107*016#NJ	D	100	16	16	6	0.6	1
TAJE107*016#NJ	E	100	16	16	6	0.9	1 ¹⁾
TAJD157*016#NJ	D	150	16	24	6	0.9	1
TAJE157*016#NJ	E	150	16	23	8	0.3	1 ¹⁾
TAJV157*016#NJ	V	150	16	24	8	0.5	1 ¹⁾
TAJE227*016#NJ	E	220	16	35.2	10	0.5	1 ¹⁾
TAJV227*016#NJ	V	220	16	35.2	8	0.9	1 ¹⁾
TAJE337M016#NJ	E	330	16	52.8	30	0.4	1 ¹⁾
20 Volt @ 85°C (13 Volt @ 125°C)							
TAJA105*020#NJ	A	1	20	0.5	4	9	1
TAJA155*020#NJ	A	1.5	20	0.5	6	6.5	1
TAJA225*020#NJ	A	2.2	20	0.5	6	5.3	1
TAJB225*020#NJ	B	2.2	20	0.5	6	3.5	1
TAJA335*020#NJ	A	3.3	20	0.7	6	4.5	1
TAJB335*020#NJ	B	3.3	20	0.7	6	3	1
TAJA475*020#NJ	A	4.7	20	0.9	6	4	1
TAJB475*020#NJ	B	4.7	20	0.9	6	3	1
TAJA685*020#NJ	A	6.8	20	1.4	6	2.4	1
TAJB685*020#NJ	B	6.8	20	1.4	6	2.5	1
TAJC685*020#NJ	C	6.8	20	1.4	6	2	1
TAJB106*020#NJ	B	10	20	2	6	2.1	1
TAJC106*020#NJ	C	10	20	2	6	1.2	1
TAJB156*020#NJ	B	15	20	3	6	2	1
TAJC156*020#NJ	C	15	20	3	6	1.7	1
TAJB226*020#NJ	B	22	20	4.4	6	1.8	1
TAJC226*020#NJ	C	22	20	4.4	6	1.6	1
TAJD226*020#NJ	D	22	20	4.4	6	0.9	1
TAJC336*020#NJ	C	33	20	6.6	6	1.5	1
TAJD336*020#NJ	D	33	20	6.6	6	0.9	1
TAJC476*020#NJ	C	47	20	9.4	6	0.5	1
TAJD476*020#NJ	D	47	20	9.4	6	0.9	1
TAJE476*020#NJ	E	47	20	9.4	6	0.9	1 ¹⁾
TAJC686M020#NJ	C	68	20	13.6	8	0.5	1
TAJD686*020#NJ	D	68	20	13.6	6	0.4	1
TAJE686*020#NJ	E	68	20	13.6	6	0.9	1 ¹⁾
TAJD107*020#NJ	D	100	20	20	6	0.5	1
TAJE107*020#NJ	E	100	20	20	6	0.4	1 ¹⁾
TAJV107*020#NJ	V	100	20	20	8	0.9	1 ¹⁾
TAJE157*020#NJ	E	150	20	30	8	0.3	1 ¹⁾
TAJV157*020#NJ	V	150	20	30	8	0.3	1 ¹⁾
25 Volt @ 85°C (17 Volt @ 125°C)							
TAJA474*025#NJ	A	0.47	25	0.5	4	14	1
TAJA684*025#NJ	A	0.68	25	0.5	4	10	1
TAJA105*025#NJ	A	1	25	0.5	4	8	1
TAJA155*025#NJ	A	1.5	25	0.5	6	7.5	1
TAJB155*025#NJ	B	1.5	25	0.5	6	5	1
TAJA225*025#NJ	A	2.2	25	0.6	6	7	1
TAJB225*025#NJ	B	2.2	25	0.6	6	4.5	1
TAJA335*025#NJ	A	3.3	25	0.8	6	3.7	1

AVX Part No.	Case Size	Cap (µF)	Rated Voltage (V)	DCL (µA) Max.	DF % Max.	ESR Max. (Ω) @100kHz	MSL
TAJB335*025#NJ	B	3.3	25	0.8	6	3.5	1
TAJA475*025#NJ	A	4.7	25	1.2	6	3.1	1
TAJB475*025#NJ	B	4.7	25	1.2	6	1.5	1
TAJB685*025#NJ	B	6.8	25	1.7	6	2.8	1
TAJC685*025#NJ	C	6.8	25	1.7	6	2	1
TAJB106*025#NJ	B	10	25	2.5	6	2.5	1
TAJC106*025#NJ	C	10	25	2.5	6	1.8	1
TAJD106*025#NJ	D	10	25	2.5	6	1.2	1
TAJC156*025#NJ	C	15	25	3.8	6	1.6	1
TAJD156*025#NJ	D	15	25	3.8	6	1	1
TAJC226*025#NJ	C	22	25	5.5	6	1.4	1
TAJD226*025#NJ	D	22	25	5.5	6	0.9	1
TAJD336*025#NJ	D	33	25	8.3	6	0.9	1
TAJE336*025#NJ	E	33	25	8.3	6	0.9	1 ¹⁾
TAJD476*025#NJ	D	47	25	11.8	6	0.9	1
TAJE476*025#NJ	E	47	25	11.8	6	0.9	1 ¹⁾
TAJE686*025#NJ	E	68	25	17	6	0.9	1 ¹⁾
TAJV686*025#NJ	V	68	25	17	6	0.9	1 ¹⁾
TAJE107M025#NJ	E	100	25	25	10	0.3	1 ¹⁾
TAJV107*025#NJ	V	100	25	25	8	0.4	1 ¹⁾
TAJV157M025#NJ	V	150	25	37.5	10	0.4	1 ¹⁾
35 Volt @ 85°C (23 Volt @ 125°C)							
TAJA104*035#NJ	A	0.1	35	0.5	4	24	1
TAJA154*035#NJ	A	0.15	35	0.5	4	21	1
TAJA224*035#NJ	A	0.22	35	0.5	4	18	1
TAJA334*035#NJ	A	0.33	35	0.5	4	15	1
TAJA474*035#NJ	A	0.47	35	0.5	4	12	1
TAJB474*035#NJ	B	0.47	35	0.5	4	10	1
TAJA684*035#NJ	A	0.68	35	0.5	4	8	1
TAJB684*035#NJ	B	0.68	35	0.5	4	8	1
TAJA105*035#NJ	A	1	35	0.5	4	7.5	1
TAJB105*035#NJ	B	1	35	0.5	4	6.5	1
TAJA155*035#NJ	A	1.5	35	0.5	6	7.5	1
TAJB155*035#NJ	B	1.5	35	0.5	6	5.2	1
TAJC155*035#NJ	C	1.5	35	0.5	6	4.5	1
TAJA225*035#NJ	A	2.2	35	0.8	6	4.5	1
TAJB225*035#NJ	B	2.2	35	0.8	6	4.2	1
TAJC225*035#NJ	C	2.2	35	0.8	6	3.5	1
TAJB335*035#NJ	B	3.3	35	1.2	6	3.5	1
TAJC335*035#NJ	C	3.3	35	1.2	6	2.5	1
TAJB475*035#NJ	B	4.7	35	1.6	6	3.1	1
TAJC475*035#NJ	C	4.7	35	1.6	6	2.2	1
TAJD475*035#NJ	D	4.7	35	1.6	6	1.5	1
TAJC685*035#NJ	C	6.8	35	2.4	6	1.8	1
TAJD685*035#NJ	D	6.8	35	2.4	6	1.3	1
TAJC106*035#NJ	C	10	35	3.5	6	1.6	1
TAJD106*035#NJ	D	10	35	3.5	6	1	1
TAJE106*035#NJ	E	10	35	3.5	6	0.9	1 ¹⁾
TAJC156*035#NJ	C	15	35	5.3	6	1.4	1
TAJD156*035#NJ	D	15	35	5.3	6	0.9	1
TAJD226*035#NJ	D	22	35	7.7	6	0.9	1
TAJE226*035#NJ	E	22	35	7.7	6	0.5	1 ¹⁾
TAJD336*035#NJ	D	33	35	11.6	6	0.9	1
TAJE336*035#NJ	E	33	35	11.6	6	0.9	1 ¹⁾
TAJV336*035#NJ	V	33	35	11.6	6	0.5	1 ¹⁾
TAJE476*035#NJ	E	47	35	16.5	6	0.9	1 ¹⁾
TAJV476*035#NJ	V	47	35	16.5	6	0.4	1 ¹⁾
TAJV686*035#NJ	V	68	35	23.8	6	0.5	1 ¹⁾

¹⁾ Dry pack option (see How to order) recommended for reduction of stress during soldering. Dry pack parts should be treated as MSL 3.

Moisture Sensitivity Level (MSL) is defined according to J-STD-020.

For AEC-Q200 availability, please contact AVX.

All technical data relates to an ambient temperature of +25°C. Capacitance and DF are measured at 120Hz, 0.5V RMS with a maximum DC bias of 2.2 volts. DCL is measured at rated voltage after 5 minutes.

For typical weight and composition see page 144.

NOTE: AVX reserves the right to supply a higher voltage rating or tighter tolerance part in the same case size, to the same reliability standards.

RATINGS & PART NUMBER REFERENCE

AVX Part No.	Case Size	Cap (µF)	Rated Voltage (V)	DCL (µA) Max.	DF % Max.	ESR Max. (Ω) @100kHz	MSL
50 Volt @ 85°C (33 Volt @ 125°C)							
TAJA104*050#NJ	A	0.1	50	0.5	4	22	1
TAJA154*050#NJ	A	0.15	50	0.5	4	15	1
TAJB154*050#NJ	B	0.15	50	0.5	4	17	1
TAJA224*050#NJ	A	0.22	50	0.5	4	18	1
TAJB224*050#NJ	B	0.22	50	0.5	4	14	1
TAJA334*050#NJ	A	0.33	50	0.5	4	17	1
TAJB334*050#NJ	B	0.33	50	0.5	4	12	1
TAJA474*050#NJ	A	0.47	50	0.5	4	9.5	1
TAJB474*050#NJ	B	0.47	50	0.7	4	9.5	1
TAJC474*050#NJ	C	0.47	50	0.5	4	8	1
TAJA684*050#NJ	A	0.68	50	0.5	4	7.9	1
TAJB684*050#NJ	B	0.68	50	0.5	4	8	1
TAJC684*050#NJ	C	0.68	50	0.5	4	7	1
TAJA105*050#NJ	A	1	50	0.5	4	6.6	1
TAJB105*050#NJ	B	1	50	0.5	6	7	1
TAJC105*050#NJ	C	1	50	0.5	4	5.5	1
TAJB155*050#NJ	B	1.5	50	0.8	8	5.4	1
TAJC155*050#NJ	C	1.5	50	0.8	6	4.5	1
TAJD155*050#NJ	D	1.5	50	0.8	6	4	1
TAJB225*050#NJ	B	2.2	50	1.1	8	4.5	1
TAJC225*050#NJ	C	2.2	50	1.1	8	2.5	1
TAJD225*050#NJ	D	2.2	50	1.1	6	2.5	1
TAJC335*050#NJ	C	3.3	50	1.6	6	2.5	1
TAJD335*050#NJ	D	3.3	50	1.7	6	2	1
TAJC475*050#NJ	C	4.7	50	0.5	4	1.4	1
TAJD475*050#NJ	D	4.7	50	2.4	6	1.4	1
TAJC685*050#NJ	C	6.8	50	3.4	6	1	1
TAJD685*050#NJ	D	6.8	50	3.4	6	1	1
TAJD106*050#NJ	D	10	50	5	6	0.8	1
TAJE106*050#NJ	E	10	50	5	6	1	1 ¹⁾
TAJV106*050#NJ	V	10	50	5	6	0.65	1 ¹⁾
TAJD156*050#NJ	D	15	50	7.5	6	0.6	1
TAJE156*050#NJ	E	15	50	7.5	6	0.6	1 ¹⁾
TAJV156*050#NJ	V	15	50	7.5	6	0.6	1 ¹⁾
TAJV226*050#NJ	V	22	50	11	8	0.6	1 ¹⁾

¹⁾ Dry pack option (see How to order) recommended for reduction of stress during soldering. Dry pack parts should be treated as MSL 3.

For AEC-Q200 availability, please contact AVX.

Moisture Sensitivity Level (MSL) is defined according to J-STD-020.

All technical data relates to an ambient temperature of +25°C. Capacitance and DF are measured at 120Hz, 0.5V RMS with a maximum DC bias of 2.2 volts. DCL is measured at rated voltage after 5 minutes.

For typical weight and composition see page 144.

NOTE: AVX reserves the right to supply a higher voltage rating or tighter tolerance part in the same case size, to the same reliability standards.

TAJ Automotive Range



Standard Tantalum - Automotive Product Range

TAJ AUTOMOTIVE RANGE CAPACITANCE AND RATED VOLTAGE, V_R (VOLTAGE CODE) RANGE (LETTER DENOTES CASE SIZE)

Capacitance		Rated voltage DC (V_R) to 85°C						
μF	Code	6.3V (J)	10V (A)	16V (C)	20V (D)	25V (E)	35V (V)	50V (T)
0.10	104							
0.15	154							A
0.22	224							
0.33	334						A	A
0.47	474					A	A	A/B
0.68	684					A	A	B
1.0	105			A	A	A	A/B	B/C
1.5	155				A	A	A/B	C
2.2	225		A	A	A/B	A/B	B/C	C/D
3.3	335	A		A/B	A/B	B	B/C	C/D
4.7	475		A/B	A/B	A/B	B/C	B/C/D	C/D
6.8	685		A/B	A/B	B/C	B/C	C/D	D
10	106	A/B	A/B	A/B/C	B/C	C/D	C/D	D/E
15	156	A	A/B/C	B/C	B/C	C/D	D	E
22	226	A/B/C	A/B/C	B/C/D	C/D	C/D	D/E	
33	336	A/B	B/C	C/D	C/D	D	E	
47	476	B/C	B/C/D	C/D	D	D/E		
68	686	B/C	C/D	C/D	D/E			
100	107	C/D	C/D	D/E	E			
150	157	C/D	D/E	E				
220	227	D	D/E					
330	337	D/E	E					
470	477	D/E						
680	687	E						

Not recommended for new designs, higher voltage or smaller case size substitution are offered.

Released codes

Engineering samples - please contact manufacturer

Note: Voltage ratings are minimum values. AVX reserves the right to supply higher ratings in the same case size, to the same reliability standards.

HOW TO ORDER

TAJ	C	106	M	035	T	NJ	V
Type	Case Size	Capacitance Code	Tolerance	Rated DC Voltage	Packaging	Specification Suffix	Dry Pack Option
	See table above	pF code: 1st two digits represent significant figures, 3rd digit represents multiplier (number of zeros to follow)	K = $\pm 10\%$ M = $\pm 20\%$	006 = 6.3Vdc 010 = 10Vdc 016 = 16Vdc 020 = 20Vdc	025 = 25Vdc 035 = 35Vdc 050 = 50Vdc	T = Automotive Lead Free 7" Reel U = Automotive Lead Free 13" Reel	(D,E case sizes mandatory)

TECHNICAL SPECIFICATIONS

Technical Data:

All technical data relate to an ambient temperature of +25°C

Capacitance Range:	0.22 μF to 680 μF								
Capacitance Tolerance:	$\pm 10\%$; $\pm 20\%$								
Rated Voltage (V_R)	$\leq +85^\circ\text{C}$:	6.3	10	16	20	25	35	50	
Category Voltage (V_C)	$\leq +125^\circ\text{C}$:	4	7	10	13	17	23	33	
Surge Voltage (V_S)	$\leq +85^\circ\text{C}$:	8	13	20	26	32	46	65	
Surge Voltage (V_S)	$\leq +125^\circ\text{C}$:	5	8	13	16	20	28	40	
Temperature Range:	-55°C to +125°C								
Environmental Classification:	55/125/56 (IEC 68-2)								
Reliability:	1% per 1000 hours at 85°C, V_R with 0.1 Ω/V series impedance, 60% confidence level								
Termination Finished:	Sn Plating (standard), Gold and SnPb Plating upon request								
	Meets requirements of AEC-Q200								



TAJ Automotive Range



Standard Tantalum - Automotive Product Range

RATINGS & PART NUMBER REFERENCE

AVX Part No.*	Case Size	Cap (µF)	Rated Voltage (V)	DCL (µA) Max.	DF % Max.	ESR Max. (Ω) @100kHz	MSL
6.3 Volt @ 85°C (4 Volt @ 125°C)							
TAJA335*006TNJ	A	3.3	6.3	0.5	6	7	1
TAJA106*006TNJ	A	10	6.3	0.6	6	4	1
TAJB106*006TNJ	B	10	6.3	0.6	6	3	1
TAJA156*006TNJ	A	15	6.3	0.9	6	3.5	1
TAJA226*006TNJ	A	22	6.3	1.4	6	3	1
TAJB226*006TNJ	B	22	6.3	1.4	6	2.5	1
TAJC226*006TNJ	C	22	6.3	1.4	6	2	1
TAJA336*006TNJ	A	33	6.3	2.1	8	2.2	1
TAJB336*006TNJ	B	33	6.3	2.1	6	2.2	1
TAJB476*006TNJ	B	47	6.3	3	6	2	1
TAJC476*006TNJ	C	47	6.3	3	6	1.6	1
TAJB686*006TNJ	B	68	6.3	4	8	0.9	1
TAJC686*006TNJ	C	68	6.3	4.3	6	1.5	1
TAJC107*006TNJ	C	100	6.3	6.3	6	0.9	1
TAJD107*006TNJV	D	100	6.3	6.3	6	0.9	3
TAJC157*006TNJ	C	150	6.3	9.5	6	1.3	1
TAJD157*006TNJV	D	150	6.3	9.5	6	0.9	3
TAJD227*006TNJV	D	220	6.3	13.9	8	0.4	3
TAJD337*006TNJV	D	330	6.3	20.8	8	0.4	3
TAJE337*006TNJV	E	330	6.3	20.8	8	0.4	3
TAJD477*006TNJV	D	470	6.3	28	12	0.4	3
TAJE477*006TNJV	E	470	6.3	28	10	0.4	3
TAJE687*006TNJV	E	680	6.3	42.8	10	0.5	3
10 Volt @ 85°C (7 Volt @ 125°C)							
TAJA225*010TNJ	A	2.2	10	0.5	6	7	1
TAJA475*010TNJ	A	4.7	10	0.5	6	5	1
TAJB475*010TNJ	B	4.7	10	0.5	6	4	1
TAJA685*010TNJ	A	6.8	10	0.7	6	4	1
TAJB685*010TNJ	B	6.8	10	0.7	6	3	1
TAJA106*010TNJ	A	10	10	1	6	3	1
TAJB106*010TNJ	B	10	10	1	6	2.1	1
TAJA156*010TNJ	A	15	10	1.5	6	3.2	1
TAJB156*010TNJ	B	15	10	1.5	6	2.8	1
TAJC156*010TNJ	C	15	10	1.5	6	2	1
TAJA226*010TNJ	A	22	10	2.2	8	3	1
TAJB226*010TNJ	B	22	10	2.2	6	2.4	1
TAJC226*010TNJ	C	22	10	2.2	6	1.8	1
TAJB336*010TNJ	B	33	10	3.3	6	1.8	1
TAJC336*010TNJ	C	33	10	3.3	6	1.6	1
TAJB476*010TNJ	B	47	10	4.7	8	1	1
TAJC476*010TNJ	C	47	10	4.7	6	1.2	1
TAJD476*010TNJV	D	47	10	4.7	6	0.4	3
TAJC686*010TNJ	C	68	10	6.8	6	1.3	1
TAJD686*010TNJV	D	68	10	6.8	6	0.9	3
TAJC107*010TNJ	C	100	10	10	8	1.2	1
TAJD107*010TNJV	D	100	10	10	6	0.9	3
TAJD157*010TNJV	D	150	10	15	8	0.9	3
TAJE157*010TNJV	E	150	10	15	8	0.9	3
TAJD227*010TNJV	D	220	10	22	8	0.5	3
TAJE227*010TNJV	E	220	10	22	8	0.5	3
TAJE337*010TNJV	E	330	10	33	8	0.9	3
16 Volt @ 85°C (10 Volt @ 125°C)							
TAJA105*016TNJ	A	1	16	0.5	4	11	1
TAJA225*016TNJ	A	2.2	16	0.5	6	6.5	1
TAJA335*016TNJ	A	3.3	16	0.5	6	5	1
TAJB335*016TNJ	B	3.3	16	0.5	6	4.5	1
TAJA475*016TNJ	A	4.7	16	0.8	6	4	1
TAJB475*016TNJ	B	4.7	16	0.8	6	3.5	1

AVX Part No.*	Case Size	Cap (µF)	Rated Voltage (V)	DCL (µA) Max.	DF % Max.	ESR Max. (Ω) @100kHz	MSL
TAJA685*016TNJ	A	6.8	16	1.1	6	3.5	1
TAJB685*016TNJ	B	6.8	16	1.1	6	2.5	1
TAJA106*016TNJ	A	10	16	1.6	6	3	1
TAJB106*016TNJ	B	10	16	1.6	6	2.8	1
TAJC106*016TNJ	C	10	16	1.6	6	2	1
TAJB156*016TNJ	B	15	16	2.4	6	2.5	1
TAJC156*016TNJ	C	15	16	2.4	6	1.8	1
TAJB226*016TNJ	B	22	16	3.5	6	2.3	1
TAJC226*016TNJ	C	22	16	3.5	6	1	1
TAJD226*016TNJV	D	22	16	3.5	6	1.1	3
TAJC336*016TNJ	C	33	16	5.3	6	1.5	1
TAJD336*016TNJV	D	33	16	5.3	6	0.9	3
TAJC476*016TNJ	C	47	16	7.5	6	0.5	1
TAJD476*016TNJV	D	47	16	7.5	6	0.9	3
TAJC686*016TNJ	C	68	16	10.9	6	1.3	1
TAJD686*016TNJV	D	68	16	10.9	6	0.9	3
TAJD107*016TNJV	D	100	16	16	6	0.6	3
TAJE107*016TNJV	E	100	16	16	6	0.9	3
TAJE157*016TNJV	E	150	16	23	8	0.3	3
20 Volt @ 85°C (13 Volt @ 125°C)							
TAJA105*020TNJ	A	1	20	0.5	4	9	1
TAJA155*020TNJ	A	1.5	20	0.5	6	6.5	1
TAJA225*020TNJ	A	2.2	20	0.5	6	5.3	1
TAJB225*020TNJ	B	2.2	20	0.5	6	3.5	1
TAJA335*020TNJ	A	3.3	20	0.7	6	4.5	1
TAJB335*020TNJ	B	3.3	20	0.7	6	3	1
TAJA475*020TNJ	A	4.7	20	0.9	6	4	1
TAJB475*020TNJ	B	4.7	20	0.9	6	3	1
TAJB685*020TNJ	B	6.8	20	1.4	6	2.5	1
TAJC685*020TNJ	C	6.8	20	1.4	6	2	1
TAJB106*020TNJ	B	10	20	2	6	2.1	1
TAJC106*020TNJ	C	10	20	2	6	1.2	1
TAJB156*020TNJ	B	15	20	3	6	2	1
TAJC156*020TNJ	C	15	20	3	6	1.7	1
TAJC226*020TNJ	C	22	20	4.4	6	1.6	1
TAJD226*020TNJV	D	22	20	4.4	6	0.9	3
TAJC336*020TNJ	C	33	20	6.6	6	1.5	1
TAJD336*020TNJV	D	33	20	6.6	6	0.9	3
TAJD476*020TNJV	D	47	20	9.4	6	0.9	3
TAJD686*020TNJV	D	68	20	13.6	6	0.4	3
TAJE686*020TNJV	E	68	20	13.6	6	0.9	3
TAJE107*020TNJV	E	100	20	20	6	0.4	3
25 Volt @ 85°C (17 Volt @ 125°C)							
TAJA474*025TNJ	A	0.47	25	0.5	4	14	1
TAJA684*025TNJ	A	0.68	25	0.5	4	10	1
TAJA105*025TNJ	A	1	25	0.5	4	8	1
TAJA155*025TNJ	A	1.5	25	0.5	6	7.5	1
TAJA225*025TNJ	A	2.2	25	0.6	6	7	1
TAJB225*025TNJ	B	2.2	25	0.6	6	4.5	1
TAJB335*025TNJ	B	3.3	25	0.8	6	3.5	1
TAJB475*025TNJ	B	4.7	25	1.2	6	1.5	1
TAJC475*025TNJ	C	4.7	25	1.2	6	2.4	1
TAJB685*025TNJ	B	6.8	25	1.7	6	2.8	1
TAJC685*025TNJ	C	6.8	25	1.7	6	2	1
TAJC106*025TNJ	C	10	25	2.5	6	1.8	1
TAJD106*025TNJV	D	10	25	2.5	6	1.2	3
TAJC156*025TNJ	C	15	25	3.8	6	1.6	1
TAJD156*025TNJV	D	15	25	3.8	6	1	3
TAJC226*025TNJ	C	22	25	5.5	6	1.4	1

Moisture Sensitivity Level (MSL) is defined according to J-STD-020

*Please use "U" instead of "T" in the suffix letter for 13" reel packaging

Please use specific PN for automotive version – see "HOW TO ORDER".

All technical data relates to an ambient temperature of +25°C. Capacitance and DF are measured at 120Hz, 0.5V RMS with a maximum DC bias of 2.2 volts.

DCL is measured at rated voltage after 5 minutes.

For typical weight and composition see page 144.

NOTE: AVX reserves the right to supply a higher voltage rating or tighter tolerance part in the same case size, to the same reliability standards.

TAJ Automotive Range



Standard Tantalum - Automotive Product Range

RATINGS & PART NUMBER REFERENCE

AVX Part No.*	Case Size	Cap (µF)	Rated Voltage (V)	DCL (µA) Max.	DF % Max.	ESR Max. (Ω) @100kHz	MSL
TAJD226*025TNJV	D	22	25	5.5	6	0.9	3
TAJD336*025TNJV	D	33	25	8.3	6	0.9	3
TAJD476*025TNJV	D	47	25	11.8	6	0.9	3
TAJE476*025TNJV	E	47	25	11.8	6	0.9	3
35 Volt @ 85°C (23 Volt @ 125°C)							
TAJA334*035TNJ	A	0.33	35	0.5	4	15	1
TAJA474*035TNJ	A	0.47	35	0.5	4	12	1
TAJA684*035TNJ	A	0.68	35	0.5	4	8	1
TAJA105*035TNJ	A	1	35	0.5	4	7.5	1
TAJB105*035TNJ	B	1	35	0.5	4	6.5	1
TAJA155*035TNJ	A	1.5	35	0.5	6	7.5	1
TAJB155*035TNJ	B	1.5	35	0.5	6	5.2	1
TAJB225*035TNJ	B	2.2	35	0.8	6	4.2	1
TAJC225*035TNJ	C	2.2	35	0.8	6	3.5	1
TAJB335*035TNJ	B	3.3	35	1.2	6	3.5	1
TAJC335*035TNJ	C	3.3	35	1.2	6	2.5	1
TAJB475*035TNJ	B	4.7	35	1.6	6	3.1	1
TAJC475*035TNJ	C	4.7	35	1.6	6	2.2	1
TAJD475*035TNJV	D	4.7	35	1.6	6	1.5	3
TAJC685*035TNJ	C	6.8	35	2.4	6	1.8	1
TAJD685*035TNJV	D	6.8	35	2.4	6	1.3	3
TAJC106*035TNJ	C	10	35	3.5	6	1.6	1
TAJD106*035TNJV	D	10	35	3.5	6	1	3
TAJD156*035TNJV	D	15	35	5.3	6	0.9	3
TAJD226*035TNJV	D	22	35	7.7	6	0.9	3
TAJE226*035TNJV	E	22	35	7.7	6	0.5	3
TAJE336*035TNJV	E	33	35	11.6	6	0.9	3
50 Volt @ 85°C (33 Volt @ 125°C)							
TAJA224*050TNJ	A	0.22	50	0.5	4	18	1
TAJA334*050TNJ	A	0.33	50	0.5	4	17	1
TAJA474*050TNJ	A	0.47	50	0.5	4	9.5	1
TAJB474*050TNJ	B	0.47	50	0.7	4	9.5	1
TAJB684*050TNJ	B	0.68	50	0.5	4	8	1
TAJB105*050TNJ	B	1	50	0.5	6	7	1
TAJC105*050TNJ	C	1	50	0.5	4	5.5	1
TAJC155*050TNJ	C	1.5	50	0.8	6	4.5	1
TAJC225*050TNJ	C	2.2	50	1.1	8	2.5	1
TAJD225*050TNJV	D	2.2	50	1.1	6	2.5	3
TAJC335*050TNJ	C	3.3	50	1.6	6	2.5	1
TAJD335*050TNJV	D	3.3	50	1.7	6	2	3
TAJC475*050TNJ	C	4.7	50	0.5	4	1.4	1
TAJD475*050TNJV	D	4.7	50	2.4	6	1.4	3
TAJD685*050TNJV	D	6.8	50	3.4	6	1	3
TAJD106*050TNJV	D	10	50	5	6	0.8	3
TAJE106*050TNJV	E	10	50	5	6	1	3
TAJE156*050TNJV	E	15	50	7.5	6	0.6	3

Moisture Sensitivity Level (MSL) is defined according to J-STD-020

*Please use "U" instead of "T" in the suffix letter for 13" reel packaging

Please use specific PN for automotive version – see "HOW TO ORDER".

All technical data relates to an ambient temperature of +25°C. Capacitance and DF are measured at 120Hz, 0.5V RMS with a maximum DC bias of 2.2 volts.

DCL is measured at rated voltage after 5 minutes.

For typical weight and composition see page 144.

NOTE: AVX reserves the right to supply a higher voltage rating or tighter tolerance part in the same case size, to the same reliability standards.

F93 Series



Resin-Molded Chip, Standard Tantalum J-Lead



For SMD

- Compliant to the RoHS directive (2002/95/EC).

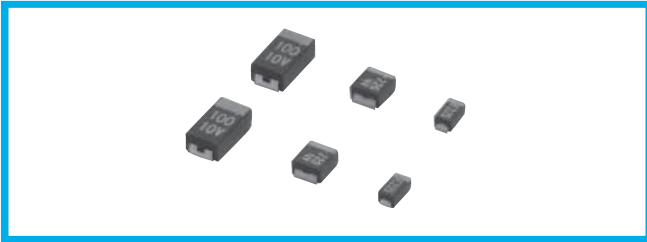

Type numbering system (Example: 10V 10μF)

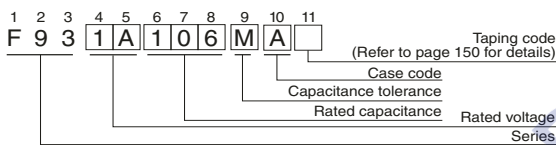

Drawing

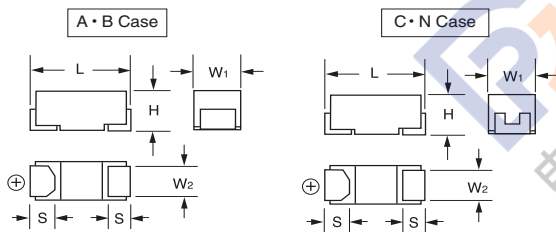

Dimensions

Case code	L	W ₁	W ₂	H	S
A	3.2 ± 0.2	1.6 ± 0.2	1.2 ± 0.1	1.6 ± 0.2	0.8 ± 0.2
B	3.5 ± 0.2	2.8 ± 0.2	2.2 ± 0.1	1.9 ± 0.2	0.8 ± 0.2
C	6.0 ± 0.2	3.2 ± 0.2	2.2 ± 0.1	2.5 ± 0.2	1.3 ± 0.2
N	7.3 ± 0.2	4.3 ± 0.2	2.4 ± 0.1	2.8 ± 0.2	1.3 ± 0.2

Marking

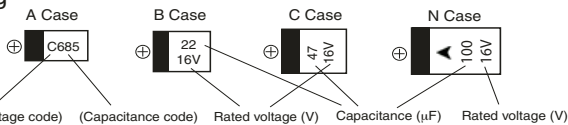

4V	G	20V	D
6.3V	J	25V	E
10V	A	35V	V
16V	C		

Standard Ratings

Cap. (μF)	Code	4	6.3	10	16	20	25	35
0.68	684	OG	OJ	1A	1C	1D	1E	1V
1	105				A		A	A
1.5	155						A	A
2.2	225				A	A	A	A · B
3.3	335				A	A	A	B
4.7	475				A	A · B	A · B	B · C
6.8	685			A	A	A · B	A · B	C
10	106		A	A	A · B	A · B	B · C	C
15	156		A	A	A · B	A · B	C	N
22	226	A	A	A · B	A · B · C	B · C	C · N	N
33	336	A	A	A · B	B · C	C · N	N	
47	476	A	A · B	A · B · C	(B) · C · N	C · N	N	
68	686	A	A · B	B · C	N	(N)		
100	107	A · B	A · B · C	B · C · N	C · N			
150	157	B	B · C	C · N	N			
220	227	(A) · B · C	B · C · N	N	N			
330	337	C	N	N				
470	477	N	N					
680	687	N						

() The series in parentheses are being developed.

Please contact to your local AVX sales office when these series are being designed in your application.

Specifications

Item	Performance Characteristics
Category	
Temperature Range	-55 to +125°C (Rated temperature : +85°C)
Capacitance Tolerance	±20%, ±10% (at 120Hz)
Dissipation Factor (120Hz)	Refer to next page
ESR (100kHz)	Refer to next page
Leakage Current	<ul style="list-style-type: none"> After 1 minute's application of rated voltage, leakage current at 20°C is not more than 0.01CV or 0.5μA, whichever is greater. After 1 minute's application of rated voltage, leakage current at 85°C is not more than 0.1CV or 5μA, whichever is greater. After 1 minute's application of derated voltage, leakage current at 125°C is not more than 0.125CV or 6.3μA, whichever is greater.
Capacitance Change by Temperature	+15% Max. (at +125°C) +10% Max. (at +85°C) -10% Max. (at -55°C)
Damp Heat (Steady State)	At 40°C 90 to 95% R.H. 500 hours (No voltage applied) Capacitance Change...Refer to next page (* 1) Dissipation Factor.....Initial specified value or less Leakage Current.....Initial specified value or less
Temperature Cycles	-55°C / +125°C 30 minutes each 5 cycles Capacitance Change...Refer to next page (* 1) Dissipation Factor.....Initial specified value or less Leakage Current.....Initial specified value or less
Resistance to Soldering Heat	10 seconds reflow at 260°C Capacitance Change...Refer to next page (* 1) Dissipation Factor.....Initial specified value or less Leakage Current.....Initial specified value or less
Surge	After application of surge voltage in series with a 33Ω resistor at the rate of 30 seconds ON, 30 seconds OFF, for 1000 successive test cycles at 85°C, capacitors shall meet the characteristic requirements table below. Capacitance Change...Refer to next page (* 1) Dissipation Factor.....Initial specified value or less Leakage Current.....Initial specified value or less
Endurance	After 2000 hours' application of rated voltage in series with a 3Ω resistor at 85°C, or derated voltage in series with a 3Ω resistor at 125°C, capacitors shall meet the characteristic requirements table below. Capacitance Change...Refer to next page (* 1) Dissipation Factor.....Initial specified value or less Leakage Current.....Initial specified value or less
Shear Test	After applying the pressure load of 5N for 10±1 seconds horizontally to the center of capacitor side body which has no electrode and has been soldered beforehand on a substrate, there shall be found neither exfoliation nor its sign at the terminal electrode. 5N (0.51kg · f) For 10±1 seconds
Terminal Strength	Keeping a capacitor surface-mounted on a substrate upside down and supporting the substrate at both of the opposite bottom points 45mm apart from the center of capacitor, the pressure strength is applied with a specified jig at the center of substrate so that the substrate may bend by 1mm as illustrated. Then, there shall be found no remarkable abnormality on the capacitor terminals. R230 20 45 45
Failure Rate	1% per 1000 hours at 85°C, V _R with 0.1Ω/V series impedance, 60% confidence level.

We can supply the type of compliance to AEC-Q200. Please contact to your local AVX sales office when these series are being designed in your application.

F93 Series



Resin-Molded Chip, Standard Tantalum J-Lead

Standard Ratings

Rated Volt	Rated Capacitance (μF)	Case code	Part Number	Leakage Current (μA)	Dissipation Factor (%@120Hz)	ESR (Ω@100kHz)	*1 ΔC/C (%)
4V	22	A	F930G226MAA	0.9	6	2.5	*
	33	A	F930G336MAA	1.3	8	2.5	*
	47	A	F930G476MAA	1.9	18	2.5	*
	68	A	F930G686MAA	2.7	24	2.5	*
	100	A	F930G107MAA	4.0	30	2.0	*
	100	B	F930G107MBA	4.0	14	0.9	*
	150	B	F930G157MBA	6.0	16	0.7	*
	220	B	F930G227MBA	8.8	18	0.7	*
	220	C	F930G227MCC	8.8	12	0.7	*
	330	C	F930G337MCC	13.2	14	0.7	*
470	N	F930G477MNC	18.8	16	0.3	*	
680	N	F930G687MNC	27.2	18	0.3	*	
6.3V	10	A	F930J106MAA	0.6	6	3.0	*
	15	A	F930J156MAA	0.9	6	2.9	*
	22	A	F930J226MAA	1.4	8	2.5	*
	33	A	F930J336MAA	2.1	8	2.5	*
	47	A	F930J476MAA	3.0	18	2.5	*
	47	B	F930J476MBA	3.0	6	1.0	*
	68	A	F930J686MAA	4.3	20	2.0	*
	68	B	F930J686MBA	4.3	8	1.0	*
	100	A	F930J107MAA	6.3	35	2.0	±15
	100	B	F930J107MBA	6.3	14	0.9	*
	100	C	F930J107MCC	6.3	8	0.7	*
	150	B	F930J157MBA	9.5	18	0.9	*
	150	C	F930J157MCC	9.5	12	0.7	*
	220	B	F930J227MBA	13.9	30	1.2	±15
	220	C	F930J227MCC	13.9	14	0.7	*
	220	N	F930J227MNC	13.9	10	0.5	*
330	N	F930J337MNC	20.8	14	0.5	*	
470	N	F930J477MNC	29.6	16	0.3	*	
10V	6.8	A	F931A685MAA	0.7	6	3.5	*
	10	A	F931A106MAA	1.0	6	3.0	*
	15	A	F931A156MAA	1.5	8	2.9	*
	22	A	F931A226MAA	2.2	12	2.5	*
	22	B	F931A226MBA	2.2	6	1.9	*
	33	A	F931A336MAA	3.3	18	2.5	*
	33	B	F931A336MBA	3.3	8	1.4	*
	47	A	F931A476MAA	4.7	40	2.0	±15
	47	B	F931A476MBA	4.7	8	1.0	*
	47	C	F931A476MCC	4.7	6	0.9	*
	68	B	F931A686MBA	6.8	12	0.9	±15
	68	C	F931A686MCC	6.8	8	0.8	*
	100	B	F931A107MBA	10.0	18	1.2	±15
	100	C	F931A107MCC	10.0	10	0.7	*
	100	N	F931A107MNC	10.0	8	0.6	*
	150	C	F931A157MCC	15.0	14	0.7	*
	150	N	F931A157MNC	15.0	10	0.6	*
	220	N	F931A227MNC	22.0	12	0.5	*
330	N	F931A337MNC	33.0	18	0.5	*	

1 : ΔC/C Marked ""

Item	A·B·C·N Case (%)
Damp Heat	±10
Temperature cycles	±5
Resistance soldering heat	±5
Surge	±5
Endurance	±10

Rated Volt	Rated Capacitance (μF)	Case code	Part Number	Leakage Current (μA)	Dissipation Factor (%@120Hz)	ESR (Ω@100kHz)	*1 ΔC/C (%)
16V	1	A	F931C105MAA	0.5	4	7.5	*
	2.2	A	F931C225MAA	0.5	4	5.0	*
	3.3	A	F931C335MAA	0.5	4	4.5	*
	4.7	A	F931C475MAA	0.8	6	4.0	*
	6.8	A	F931C685MAA	1.1	6	3.5	*
	10	A	F931C106MAA	1.6	6	3.0	*
	10	B	F931C106MBA	1.6	6	2.0	*
	15	A	F931C156MAA	2.4	10	3.0	*
	15	B	F931C156MBA	2.4	6	2.0	*
	22	A	F931C226MAA	3.5	15	3.0	±15
	22	B	F931C226MBA	3.5	8	1.9	*
	22	C	F931C226MCC	3.5	6	1.1	*
	33	B	F931C336MBA	5.3	8	1.9	*
	33	C	F931C336MCC	5.3	6	1.1	*
	47	C	F931C476MCC	7.5	8	0.9	*
	47	N	F931C476MNC	7.5	6	0.7	*
20V	68	N	F931C686MNC	10.9	6	0.6	*
	100	C	F931C107MCC	16.0	15	0.7	±10
	100	N	F931C107MNC	16.0	10	0.6	*
	150	N	F931C157MNC	24.0	15	0.6	*
	220	N	F931C227MNC	35.2	25	0.7	±10
	2.2	A	F931D225MAA	0.5	4	5.0	*
	3.3	A	F931D335MAA	0.7	4	4.5	*
	4.7	A	F931D475MAA	0.9	6	3.0	*
	4.7	B	F931D475MBA	0.9	6	2.8	*
	6.8	A	F931D685MAA	1.4	6	3.5	*
25V	6.8	B	F931D685MBA	1.4	6	2.5	*
	10	A	F931D106MAA	2.0	8	3.5	*
	10	B	F931D106MBA	2.0	6	2.1	*
	15	C	F931D156MCC	3.0	6	1.2	*
	22	B	F931D226MBA	4.4	8	1.9	*
	22	C	F931D226MCC	4.4	8	1.1	*
	33	C	F931D336MCC	6.6	8	1.1	*
	33	N	F931D336MNC	6.6	6	0.7	*
	47	C	F931D476MCC	9.4	10	1.1	*
	47	N	F931D476MNC	9.4	8	0.7	*
35V	1	A	F931E105MAA	0.5	4	7.5	*
	1.5	A	F931E155MAA	0.5	4	6.7	*
	2.2	A	F931E225MAA	0.6	6	6.3	*
	3.3	A	F931E335MAA	0.8	6	6.0	*
	4.7	A	F931E475MAA	1.2	8	4.0	*
	4.7	B	F931E475MBA	1.2	6	2.8	*
	10	B	F931E106MBA	2.5	12	1.9	*
	10	C	F931E106MCC	2.5	6	1.5	*
	15	C	F931E156MCC	3.8	8	1.2	*
	22	C	F931E226MCC	5.5	8	1.1	*
	22	N	F931E226MNC	5.5	6	0.7	*
	33	N	F931E336MNC	8.3	8	0.7	*
47	N	F931E476MNC	11.8	8	0.7	*	
35V	0.68	A	F931V684MAA	0.5	4	7.6	*
	1	A	F931V105MAA	0.5	4	7.5	*
	1.5	A	F931V155MAA	0.5	6	7.5	*
	2.2	A	F931V225MAA	0.8	6	7.0	*
	2.2	B	F931V225MBA	0.8	4	3.8	*
	3.3	B	F931V335MBA	1.2	4	3.5	*
	4.7	B	F931V475MBA	1.6	8	3.1	*
	4.7	C	F931V475MCC	1.6	6	1.8	*
	6.8	C	F931V685MCC	2.4	6	1.8	*
	10	C	F931V106MCC	3.5	6	1.6	*
15	N	F931V156MNC	5.3	6	0.7	*	
22	N	F931V226MNC	7.7	8	0.7	*	

* In case of capacitance tolerance ±10% type, [K] will be put at 9th digit of type numbering system.



F93-AJ6 Series



Resin-Molded Chip - Automotive Product Range



- Compliant to the RoHS directive (2002/95/EC)
- Compliant to AEC-Q200

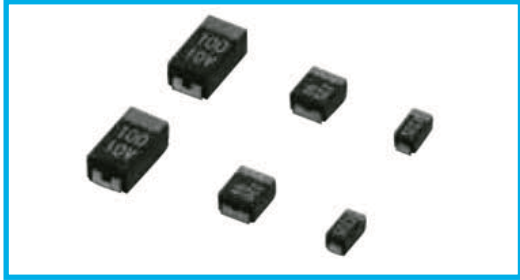

APPLICATIONS

- Cabin electronics
- Infotainment

HOW TO ORDER

(Example : 10V 10 μ F)

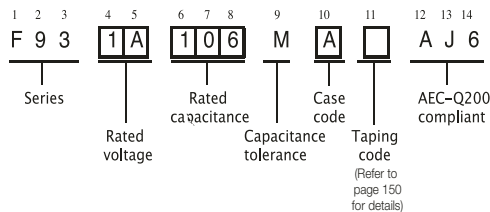

CASE DIMENSIONS

(mm)

Case Code	L	W ₁	W ₂	H	S
A	3.2 ± 0.2	1.6 ± 0.2	1.2 ± 0.1	1.6 ± 0.2	0.8 ± 0.2
B	3.5 ± 0.2	2.8 ± 0.2	2.2 ± 0.1	1.9 ± 0.2	0.8 ± 0.2
C	6.0 ± 0.2	3.2 ± 0.2	2.2 ± 0.1	2.5 ± 0.2	1.3 ± 0.2
N	7.3 ± 0.2	4.3 ± 0.2	2.4 ± 0.1	2.8 ± 0.2	1.3 ± 0.2

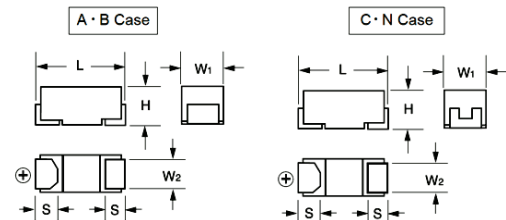

MARKING

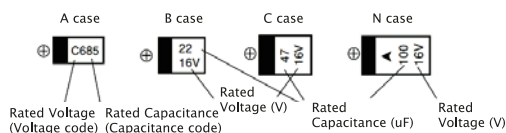

CAPACITANCE AND RATED VOLTAGE, VR (VOLTAGE CODE) RANGE (LETTER DENOTES CASE SIZE)

Capacitance		Rated Voltage						
(μ F)	Code	4V (0G)	6.3V (0J)	10V (1A)	16V (1C)	20V (1D)	25V (1E)	35V (1V)
1	105				A		A	A
1.5	155						A	A
2.2	225				A	A	A	A,B
3.3	335				A	A	A	B
4.7	475				A	A,B	A,B	B,C
6.8	685			A	A	A,B		C
10	106		A	A	A,B	A,B	B,C	C
15	156		A	A	A,B	C	C	N
22	226	A	A	A,B	B,C	B,C	C,N	N
33	336	A	A	A,B	B,C	C,N	N	
47	476	A	A,B	B,C	C,N	C,N	N	
68	686	A	A,B	B,C	N			
100	107	A,B	B,C	C,N	N			
150	157	B	B,C	N	N			
220	227	B,C	C,N	N				
330	337	C	N	N				
470	477	N	N					
680	687	N						

SPECIFICATIONS

ITEM	PERFORMANCE CHARACTERISTICS
Category Temperature Range	-55 to +125°C (Rated temperature : +85°C)
Capacitance Tolerance	±20%, ±10% (at 120Hz)
Dissipation Factor	Refer to next page
ESR (100KHz)	Refer to next page
Leakage Current	<ul style="list-style-type: none"> After 1 minute's application of rated voltage, leakage current at 20°C is not more than 0.01CV or 0.5μA, whichever is greater. After 1 minute's application of rated voltage, leakage current at 85°C is not more than 0.1CV or 5μA, whichever is greater. After 1 minute's application of derated voltage, leakage current at 125°C is not more than 0.125CV or 6.3μA, whichever is greater.
Capacitance Change by Temperature	+15% Max. (at +125°C) +10% Max. (at +85°C) -10% Max. (at -55°C)
Damp Heat (Steady State)	At 40°C, 90 to 95% R.H. 500 hours (No voltage applied) Capacitance Change Refer to next page (*1) Dissipation Factor Initial specified value or less Leakage Current Initial specified value or less
Load Humidity	After 1000 hour's application of rated voltage in series with a 33 Ω resistor at 85°C, 85% R.H., capacitors meet the characteristics requirements table below. Capacitance Change Refer to next page (*1) Dissipation Factor Initial specified value or less Leakage Current 125% or less than the initial specified value
Temperature Cycles	At -55°C / +125°C, For 30 minutes each, 1000 cycles Capacitance Change Refer to next page (*1) Dissipation Factor Initial specified value or less Leakage Current Initial specified value or less
Resistance to Soldering Heat	10 seconds reflow at 260°C, 10 seconds immersion at 260°C. Capacitance Change Refer to next page (*1) Dissipation Factor Initial specified value or less Leakage Current Initial specified value or less
Surge	After application of surge in series with a 33 Ω resistor at the rate of 30 seconds ON, 30 seconds OFF, for 1000 successive test cycles at 85°C, capacitors shall meet the characteristic requirements table below. Capacitance Change Refer to next page (*1) Dissipation Factor Initial specified value or less Leakage Current Initial specified value or less
Endurance	After 2000 hours' application of rated voltage in series with a 3 Ω resistor at 85°C, or derated voltage in series with a 3 Ω resistor at 125°C, capacitors shall meet the characteristic requirements table below. Capacitance Change Refer to next page (*1) Dissipation Factor Initial specified value or less Leakage Current Initial specified value or less
Shear Test	After applying the pressure load of 17.7N for 60 seconds horizontally to the center of capacitor side body which has no electrode and has been soldered beforehand on a substrate, there shall be found neither exfoliation nor its sign at the terminal electrode.
Terminal Strength	Keeping a capacitor surface-mounted on a substrate upside down and supporting the substrate at both of the opposite bottom points 45mm apart from the center of capacitor, the pressure strength is applied with a specified jig at the center of the substrate so that substrate may bend by 1mm as illustrated. Then, there shall be found no remarkable abnormality on the capacitor terminals.
Failure Rate	1% per 1000 hours at 85°C, V _R with 0.1 Ω /V series impedance, 60% confidence level.



F93-AJ6 Series



Resin-Molded Chip - Automotive Product Range

RATINGS & PART NUMBER REFERENCE

Rated Volt	Rated Capacitance (µF)	Case Code	Part Number	Leakage Current (µA)	Dissipation Factor (%@120Hz)	ESR (Ω@100kHz)	*1 ΔC/C (%)
4V	22	A	F930G226MAAAJ6	0.9	6	2.5	*
	33	A	F930G336MAAAJ6	1.3	8	2.5	*
	47	A	F930G476MAAAJ6	1.9	18	2.5	*
	68	A	F930G686MAAAJ6	2.7	24	2.5	*
	100	A	F930G107MAAAJ6	4	30	2	*
	100	B	F930G107MBAAJ6	4	14	0.9	*
	150	B	F930G157MBAAJ6	6	16	0.7	*
	220	B	F930G227MBAAJ6	8.8	18	0.7	*
	220	C	F930G227MCCAJ6	8.8	12	0.7	*
	330	C	F930G337MCCAJ6	13.2	14	0.7	*
	470	N	F930G477MNCAJ6	18.8	16	0.3	*
680	N	F930G687MNCAJ6	27.2	18	0.3	*	
6.3V	10	A	F930J106MAAAJ6	0.6	6	3	*
	15	A	F930J156MAAAJ6	0.9	6	2.9	*
	22	A	F930J226MAAAJ6	1.4	8	2.5	*
	33	A	F930J336MAAAJ6	2.1	8	2.5	*
	47	A	F930J476MAAAJ6	3	18	2.5	*
	47	B	F930J476MBAAJ6	3	6	1	*
	68	A	F930J686MAAAJ6	4.3	20	2	*
	68	B	F930J686MBAAJ6	4.3	8	1	*
	100	B	F930J107MBAAJ6	6.3	14	0.9	*
	100	C	F930J107MCCAJ6	6.3	8	0.7	*
	150	B	F930J157MBAAJ6	9.5	18	0.9	*
	150	C	F930J157MCCAJ6	9.5	12	0.7	*
	220	C	F930J227MCCAJ6	13.9	14	0.7	*
	220	N	F930J227MNCAJ6	13.9	10	0.5	*
	330	N	F930J337MNCAJ6	20.8	14	0.5	*
470	N	F930J477MNCAJ6	29.6	16	0.3	*	
10V	6.8	A	F931A685MAAAJ6	0.7	6	3.5	*
	10	A	F931A106MAAAJ6	1	6	3	*
	15	A	F931A156MAAAJ6	1.5	8	2.9	*
	22	A	F931A226MAAAJ6	2.2	12	2.5	*
	22	B	F931A226MBAAJ6	2.2	6	1.9	*
	33	A	F931A336MAAAJ6	3.3	18	2.5	*
	33	B	F931A336MBAAJ6	3.3	8	1.4	*
	47	B	F931A476MBAAJ6	4.7	8	1	*
	47	C	F931A476MCCAJ6	4.7	6	0.9	*
	68	B	F931A686MBAAJ6	6.8	12	0.9	±15
	68	C	F931A686MCCAJ6	6.8	8	0.8	*
	100	C	F931A107MCCAJ6	10	10	0.7	*
	100	N	F931A107MNCAJ6	10	8	0.6	*
	150	N	F931A157MNCAJ6	15	10	0.6	*
	220	N	F931A227MNCAJ6	22	12	0.5	*
330	N	F931A337MNCAJ6	33	18	0.5	*	

1: ΔC/C Marked “”

Item	All Case (%)
Damp heat, steady state	±10
Rapid change of temperature	±10
Resistance to soldering heat	±10
Surge	±10
Endurance	±10

Rated Volt	Rated Capacitance (µF)	Case Code	Part Number	Leakage Current (µA)	Dissipation Factor (%@120Hz)	ESR (Ω@100kHz)	*1 ΔC/C (%)	
16V	1	A	F931C105MAAAJ6	0.5	4	7.5	*	
	2.2	A	F931C225MAAAJ6	0.5	4	5	*	
	3.3	A	F931C335MAAAJ6	0.5	4	4.5	*	
	4.7	A	F931C475MAAAJ6	0.8	6	4	*	
	6.8	A	F931C685MAAAJ6	1.1	6	3.5	*	
	10	A	F931C106MAAAJ6	1.6	6	3	*	
	10	B	F931C106MBAAJ6	1.6	6	2	*	
	15	A	F931C156MAAAJ6	2.4	10	3	*	
	15	B	F931C156MBAAJ6	2.4	6	2	*	
	22	B	F931C226MBAAJ6	3.5	8	1.9	*	
	22	C	F931C226MCCAJ6	3.5	6	1.1	*	
	33	B	F931C336MBAAJ6	5.3	8	1.9	*	
	33	C	F931C336MCCAJ6	5.3	6	1.1	*	
	47	C	F931C476MCCAJ6	7.5	8	0.9	*	
	47	N	F931C476MNCAJ6	7.5	6	0.7	*	
68	N	F931C686MNCAJ6	10.9	6	0.6	*		
100	N	F931C107MNCAJ6	16	10	0.6	*		
20V	150	N	F931C157MNCAJ6	24	15	0.6	*	
	2.2	A	F931D225MAAAJ6	0.5	4	5	*	
	3.3	A	F931D335MAAAJ6	0.7	4	4.5	*	
	4.7	A	F931D475MAAAJ6	0.9	6	3	*	
	4.7	B	F931D475MBAAJ6	0.9	6	2.8	*	
	6.8	A	F931D685MAAAJ6	1.4	6	3.5	*	
	6.8	B	F931D685MBAAJ6	1.4	6	2.5	*	
	10	A	F931D106MAAAJ6	2	8	3.5	*	
	10	B	F931D106MBAAJ6	2	6	2.1	*	
	15	C	F931D156MCCAJ6	3	6	1.2	*	
	22	B	F931D226MBAAJ6	4.4	8	1.9	*	
	22	C	F931D226MCCAJ6	4.4	8	1.1	*	
	33	C	F931D336MCCAJ6	6.6	8	1.1	*	
	33	N	F931D336MNCAJ6	6.6	6	0.7	*	
	47	C	F931D476MCCAJ6	9.4	10	1.1	*	
47	N	F931D476MNCAJ6	9.4	8	0.7	*		
25V	1	A	F931E105MAAAJ6	0.5	4	7.5	*	
	1.5	A	F931E155MAAAJ6	0.5	4	6.7	*	
	2.2	A	F931E225MAAAJ6	0.6	6	6.3	*	
	3.3	A	F931E335MAAAJ6	0.8	6	6	*	
	4.7	A	F931E475MAAAJ6	1.2	8	4	*	
	4.7	B	F931E475MBAAJ6	1.2	6	2.8	*	
	10	B	F931E106MBAAJ6	2.5	12	1.9	*	
	10	C	F931E106MCCAJ6	2.5	6	1.5	*	
	15	C	F931E156MCCAJ6	3.8	8	1.2	*	
	22	C	F931E226MCCAJ6	5.5	8	1.1	*	
	22	N	F931E226MNCAJ6	5.5	6	0.7	*	
	33	N	F931E336MNCAJ6	8.3	8	0.7	*	
	47	N	F931E476MNCAJ6	11.8	8	0.7	*	
	35V	1	A	F931V105MAAAJ6	0.5	4	7.5	*
		1.5	A	F931V155MAAAJ6	0.5	6	7.5	*
2.2		A	F931V225MAAAJ6	0.8	6	7	*	
2.2		B	F931V225MBAAJ6	0.8	4	3.8	*	
3.3		B	F931V335MBAAJ6	1.2	4	3.5	*	
4.7		B	F931V475MBAAJ6	1.6	8	3.1	*	
4.7		C	F931V475MCCAJ6	1.6	6	1.8	*	
6.8		C	F931V685MCCAJ6	2.4	6	1.8	*	
10		C	F931V106MCCAJ6	3.5	6	1.6	*	
15		N	F931V156MNCAJ6	5.3	6	0.7	*	
22		N	F931V226MNCAJ6	7.7	8	0.7	*	

* In case of capacitance tolerance ± 10% type, “K” will be put at 9th digit of type numbering system

Standard Microchip

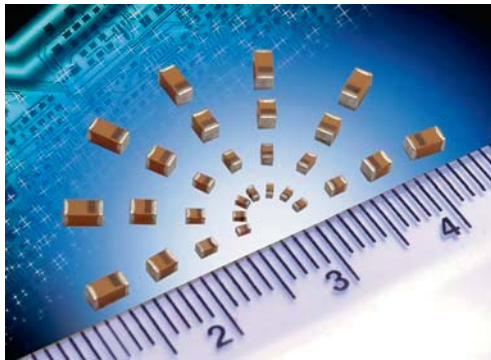

- The world's smallest surface mount tantalum capacitor
- CV range: 0.10-150µF / 2-25V
- 5 case sizes available
- Low profile options available
- Industrial and hi-rel medical applications



LEAD-FREE
LEAD-FREE COMPATIBLE
COMPONENT



CASE DIMENSIONS: millimeters (inches)

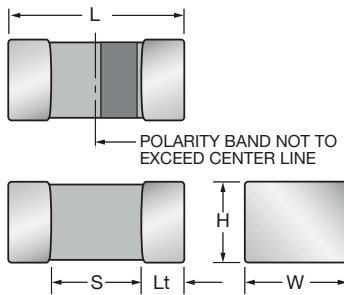

Code	EIA Code	EIA Metric	L+0.20 (0.008) -0.00 (0.000)	W+0.15 (0.006) -0.00 (0.000)	H+0.15 (0.006) -0.00 (0.000)	Termination Spacing(S)	Minimum Termination Length (Lt)
A	1206	3216-18	3.20 ± 0.20 (0.126 ± 0.008)	1.60 ± 0.20 (0.06 ± 0.008)	1.60 ± 0.20 (0.063 ± 0.008)	1.80 (0.071) min	0.15 (0.006)
B	1210	3528-15	3.50 ± 0.20 (0.138 ± 0.008)	2.80 +0.20 -0.10 (0.110 +0.008 -0.004)	1.50 (0.059) max	2.00 (0.079) min	0.15 (0.006)
K	0402	1005-07	1.00 (0.039)	0.50 +0.20 -0.00 (0.020 +0.008 -0.000)	0.50 +0.20 -0.00 (0.020 +0.008 -0.000)	0.40 (0.016) min	0.10 (0.004)
L	0603	1608-10	1.60 (0.063)	0.85 (0.033)	0.85 (0.033)	0.55 (0.022) min	0.15 (0.006)
R	0805	2012-15	2.00 (0.079)	1.35 (0.053)	1.35 (0.053)	0.70 (0.027) min	0.15 (0.006)

HOW TO ORDER

TAC	L	226	M	004	R	TA
Type TACmicrochip®	Case Size See table above	Capacitance Code pF code: 1st two digits represent significant figures, 3rd digit represents multiplier (number of zeros to follow)	Tolerance K=±10% M=±20%	Rated DC Voltage 002=2Vdc 003=3Vdc 004=4Vdc 006=6.3Vdc 010=10Vdc 016=16Vdc 020=20Vdc 025=25Vdc 035=35Vdc 050=50Vdc	Packaging R, P = 7" Standard Tin Termination Plastic Tape X, Q = 4 1/4" Standard Tin Termination Plastic Tape A = 7" Gold Termination Plastic Tape F = 4 1/4" Gold Termination Plastic Tape	Alternative characters may be used for special requirements

TECHNICAL SPECIFICATIONS

Technical Data:	All technical data relate to an ambient temperature of +25°C										
Capacitance Range:	0.10 µF to 150 µF										
Capacitance Tolerance:	±10%; ±20%										
Leakage Current DCL:	0.01CV or 0.5µA whichever is the greater										
Rated Voltage (V _R)	≤ +85°C:	2	3	4	6.3	10	16	20	25	35	50
Category Voltage (V _C)	≤ +125°C:	1.3	2	2.7	4	7	10	13	17	23	33
Surge Voltage (V _S)	≤ +85°C:	2.7	3.9	5.2	8	13	20	26	32	46	65
Surge Voltage (V _S)	≤ +125°C:	1.7	2.6	3.2	5	8	12	16	20	28	40
Temperature Range:	-55°C to +125°C										
Reliability:	1% per 1000 hours at 85°C, V _R with 0.1Ω/V series impedance, 60% confidence level										
Termination Finish:	Nickel and Tin Plating (standard), Nickel and Gold Plating option available upon request										

STANDARD COMMERCIAL RANGE (EIA SIZES) (LETTER DENOTES CASE SIZE)

Capacitance		Voltage Rating DC (V _R) at 85°C									
µF	Code	2.0V	3.0V	4.0V	6.3V	10V	16V	20V	25V	35V	50V
0.10	104						K ^(M)	K*		L*	
0.15	154					K ^(M)	K ^(M)				
0.22	224					K ^(M)	K ^(M)	K ^(M)		L*	
0.33	334					K ^(M)	K ^(M)				
0.47	474					K ^(M) /L	L				
0.68	684					K ^(M) /L	L				
1.0	105				K/L	K/L	L		R		A*
1.5	155			L	L	L					
2.2	225		K ^(M) /L	L	K ^(M) /L	L	L				
3.3	335	K ^(M) /L	K ^(M) /L	L	L	L/R	R*	R ^(M)			
4.7	475	K ^(M) /L	K ^(M) /L	L	L	L/R		R ^(M)	A*		
6.8	685	K ^(M) /L	L	L	L/R	L/R					
10	106	K ^(M) /L	L	L/R	L ^(M) /R	L/R	R				
15	156		R	L ^(M) /R	L ^(M) /R	R					
22	226	R	L ^(M) /R	L ^(M) /R	R	R					
33	336	R	R	R	R	A ^(M) /B ^(M) /R ^(M)					
47	476	R	R	R	A/R ^(M)	B					
68	686	R ^(M)	R ^(M)	A ^(M)	A ^{(M)*}						
100	107		A ^(M) /R ^(M)	A ^(M) /R ^(M)	A ^(M)						
150	157	A ^(M)									
220	227										

ESR limits quoted in brackets (Ohms)

Released codes ^(M tolerance only)

Engineering samples - please contact manufacturer

*Codes under development - subject to change.

Standard Height Profile: A, B, K, L, R Case

Low Profile: H, J, T, U, V Case

Note: Voltage ratings are minimum values. AVX reserves the right to supply higher ratings in the same case size, to the same reliability standards.

RATINGS & PART NUMBER REFERENCE

AVX Part No.	EIA Code	EIA Metric	Case Size	Cap (µF)	Rated Voltage (V)	DCL (µA) Max.	DF % Max.	ESR Max. (Ω) @100kHz	MSL
2 Volt @ 85°C (1.3 Volt @ 125°C)									
TACK335M002#TA	0402	1005-07	K	3.3	2	0.5	8	15	1
TACL335*002#TA	0603	1608-10	L	3.3	2	0.5	6	7.5	1
TACK475M002#TA	0402	1005-07	K	4.7	2	0.5	12	15	1
TACL475*002#TA	0603	1608-10	L	4.7	2	0.5	6	7.5	1
TACK685M002#TA	0402	1005-07	K	6.8	2	0.5	20	15	1
TACL685*002#TA	0603	1608-10	L	6.8	2	0.5	6	7.5	1
TACK106M002#TA	0402	1005-07	K	10	2	0.5	15	15	1
TACL106*002#TA	0603	1608-10	L	10	2	0.5	10	7.5	1
TACR226*002#TA	0805	2012-15	R	22	2	0.5	8	5	1
TACR336*002#TA	0805	2012-15	R	33	2	0.7	10	5	1
TACR476*002#TA	0805	2012-15	R	47	2	0.9	10	5	1
TACR686M002#TA	0805	2012-15	R	68	2	1.4	14	5	1
TACA157M002#TA	1206	3216-18	A	150	2	3	20	1	1
3 Volt @ 85°C (2 Volt @ 125°C)									
TACK225M003#TA	0402	1005-07	K	2.2	3	0.5	6	15	1
TACL225*003#TA	0603	1608-10	L	2.2	3	0.5	6	7.5	1
TACK335M003#TA	0402	1005-07	K	3.3	3	0.5	8	15	1
TACL335*003#TA	0603	1608-10	L	3.3	3	0.5	6	7.5	1
TACK475M003#TA	0402	1005-07	K	4.7	3	0.5	12	15	1
TACL475*003#TA	0603	1608-10	L	4.7	3	0.5	6	7.5	1
TACL685*003#TA	0603	1608-10	L	6.8	3	0.5	6	7.5	1
TACL106*003#TA	0603	1608-10	L	10	3	0.5	10	7.5	1
TACR156*003#TA	0805	2012-15	R	15	3	0.5	8	5	1
TACL226M003#TA	0603	1608-10	L	22	3	0.7	20	7.5	1
TACR226*003#TA	0805	2012-15	R	22	3	0.7	8	5	1
TACR336*003#TA	0805	2012-15	R	33	3	1	10	5	1
TACR476*003#TA	0805	2012-15	R	47	3	1.5	10	5	1
TACR686M003#TA	0805	2012-15	R	68	3	2	14	5	1
TACA107M003#TA	1206	3216-18	A	100	3	3	15	1	1
TACR107M003#TA	0805	2012-15	R	100	3	3	30	5	1
4 Volt @ 85°C (2.7 Volt @ 125°C)									
TACL155*004#TA	0603	1608-10	L	1.5	4	0.5	6	7.5	1
TACL225*004#TA	0603	1608-10	L	2.2	4	0.5	6	7.5	1
TACL335*004#TA	0603	1608-10	L	3.3	4	0.5	6	7.5	1
TACL475*004#TA	0603	1608-10	L	4.7	4	0.5	6	7.5	1
TACL685*004#TA	0603	1608-10	L	6.8	4	0.5	8	7.5	1
TACL106*004#TA	0603	1608-10	L	10	4	0.5	10	7.5	1
TACR106*004#TA	0805	2012-15	R	10	4	0.5	8	5	1
TACL156M004#TA	0603	1608-10	L	15	4	0.6	20	7.5	1
TACR156*004#TA	0805	2012-15	R	15	4	0.6	8	5	1
TACL226M004#TA	0603	1608-10	L	22	4	0.9	20	7.5	1
TACR226*004#TA	0805	2012-15	R	22	4	0.9	8	5	1
TACR336*004#TA	0805	2012-15	R	33	4	1.3	10	5	1
TACR476*004#TA	0805	2012-15	R	47	4	1.9	14	5	1
TACA686M004#TA	1206	3216-18	A	68	4	2.7	15	1	1
TACA107M004#TA	1206	3216-18	A	100	4	4	20	1	1
TACR107M004#TA	0805	2012-15	R	100	4	4	30	5	1
6.3 Volt @ 85°C (4 Volt @ 125°C)									
TACK105*006#TA	0402	1005-07	K	1	6.3	0.5	6	15	1
TACL105*006#TA	0603	1608-10	L	1	6.3	0.5	6	7.5	1
TACL155*006#TA	0603	1608-10	L	1.5	6.3	0.5	6	7.5	1
TACK225M006#TA	0402	1005-07	K	2.2	6.3	0.5	8	15	1
TACL225*006#TA	0603	1608-10	L	2.2	6.3	0.5	6	7.5	1
TACL335*006#TA	0603	1608-10	L	3.3	6.3	0.5	6	7.5	1
TACL475*006#TA	0603	1608-10	L	4.7	6.3	0.5	8	7.5	1
TACL685*006#TA	0603	1608-10	L	6.8	6.3	0.5	10	7.5	1
TACR685*006#TA	0805	2012-15	R	6.8	6.3	0.5	8	5	1

AVX Part No.	EIA Code	EIA Metric	Case Size	Cap (µF)	Rated Voltage (V)	DCL (µA) Max.	DF % Max.	ESR Max. (Ω) @100kHz	MSL
TACL106M006#TA	0603	1608-10	L	10	6.3	0.6	10	6	1
TACR106*006#TA	0805	2012-15	R	10	6.3	0.6	8	5	1
TACL156M006#TA	0603	1608-10	L	15	6.3	0.9	20	7.5	1
TACR156*006#TA	0805	2012-15	R	15	6.3	0.9	8	5	1
TACR226*006#TA	0805	2012-15	R	22	6.3	1.4	10	5	1
TACR336*006#TA	0805	2012-15	R	33	6.3	2.1	12	5	1
TACA476*006#TA	1206	3216-18	A	47	6.3	3	15	1	1
TACR476M006#TA	0805	2012-15	R	47	6.3	3	20	5	1
TACA686M006#TA	1206	3216-18	A	68	6.3	4.3	15	1	1
TACA107M006#TA	1206	3216-18	A	100	6.3	6.3	20	1	1
10 Volt @ 85°C (7 Volt @ 125°C)									
TACK154M010#TA	0402	1005-07	K	0.15	10	0.5	6	40	1
TACK224M010#TA	0402	1005-07	K	0.22	10	0.5	6	30	1
TACK334M010#TA	0402	1005-07	K	0.33	10	0.5	6	20	1
TACK474M010#TA	0402	1005-07	K	0.47	10	0.5	6	15	1
TACK684M010#TA	0402	1005-07	K	0.68	10	0.5	8	15	1
TACL684*010#TA	0603	1608-10	L	0.68	10	0.5	6	7.5	1
TACK105*010#TA	0402	1005-07	K	1	10	0.5	6	15	1
TACL105*010#TA	0603	1608-10	L	1	10	0.5	6	7.5	1
TACL155*010#TA	0603	1608-10	L	1.5	10	0.5	6	7.5	1
TACL225*010#TA	0603	1608-10	L	2.2	10	0.5	6	7.5	1
TACL335*010#TA	0603	1608-10	L	3.3	10	0.5	8	7.5	1
TACR335*010#TA	0805	2012-15	R	3.3	10	0.5	8	5	1
TACL475*010#TA	0603	1608-10	L	4.7	10	0.5	10	6	1
TACR475*010#TA	0805	2012-15	R	4.7	10	0.5	8	6	1
TACL685*010#TA	0603	1608-10	L	6.8	10	0.7	20	7.5	1
TACR685*010#TA	0805	2012-15	R	6.8	10	0.7	8	5	1
TACL106*010#TA	0603	1608-10	L	10	10	1	20	7.5	1
TACR106*010#TA	0805	2012-15	R	10	10	1	8	5	1
TACR156*010#TA	0805	2012-15	R	15	10	1.5	10	5	1
TACR226*010#TA	0805	2012-15	R	22	10	2.2	14	5	1
TACA336M010#TA	1206	3216-18	A	33	10	3.3	12	1	1
TACB336*010#TA	1210	3528-15	B	33	10	3.3	15	1	1
TACR336M010#TA	0805	2012-15	R	33	10	3.3	20	5	1
TACB476*010#TA	1210	3528-15	B	47	10	4.7	15	1	1
16 Volt @ 85°C (10 Volt @ 125°C)									
TACK104M016#TA	0402	1005-07	K	0.1	16	0.5	6	40	1
TACK154M016#TA	0402	1005-07	K	0.15	16	0.5	6	30	1
TACK224M016#TA	0402	1005-07	K	0.22	16	0.5	6	20	1
TACK334M016#TA	0402	1005-07	K	0.33	16	0.5	6	20	1
TACL474*016#TA	0603	1608-10	L	0.47	16	0.5	6	7.5	1
TACL684*016#TA	0603	1608-10	L	0.68	16	0.5	6	7.5	1
TACL105*016#TA	0603	1608-10	L	1	16	0.5	6	7.5	1
TACL225*016#TA	0603	1608-10	L	2.2	16	0.5	10	7.5	1
TACR335*016#TA	0805	2012-15	R	3.3	16	0.5	8	5	1
TACR106*016#TA	0805	2012-15	R	10	16	1.6	10	5	1
20 Volt @ 85°C (13 Volt @ 125°C)									
TACK104*020#TA	0402	1005-07	K	0.10	20	0.5	6	40	1
TACK224M020#TA	0402	1005-07	K	0.22	20	0.5	6	20	1
TACR335M020#TA	0805	2012-15	R	3.3	20	0.7	8	5	1
TACR475M020#TA	0805	2012-15	R	47	20	0.9	8	5	1
25 Volt @ 85°C (17 Volt @ 125°C)									
TACR105*025#TA	0805	2012-15	R	1	25	0.5	8	5	1
TACA475*025#TA	1206	3216-18	A	47	25	1.2	8	1	1
50 Volt @ 85°C (33 Volt @ 125°C)									
TACA105*050#TA	1206	3216-18	A	1.0	50	0.5	6	1	1

Moisture Sensitivity Level (MSL) is defined according to J-STD-020.

All technical data relates to an ambient temperature of +25°C. Capacitance and DF are measured at 120Hz, 0.5V RMS with a maximum DC bias of 2.2 volts. DCL is measured at rated voltage after 5 minutes.

For typical weight and composition see page 144.

NOTE: AVX reserves the right to supply a higher voltage rating or tighter tolerance part in the same case size, to the same reliability standards.

F95 Series



Standard Conformal Coated Chip

FRAMELESS™



For SMD



Smaller



For High Frequency

Upgrade

- Compliant to the RoHS directive (2002/95/EC).

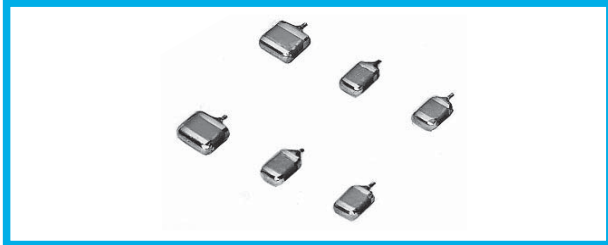

Applications

- Smartphone
- Wireless module
- Tablet PC
- e-book

Type numbering system (Example: 4V 330 μF)

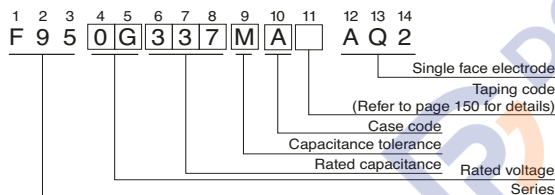

Drawing

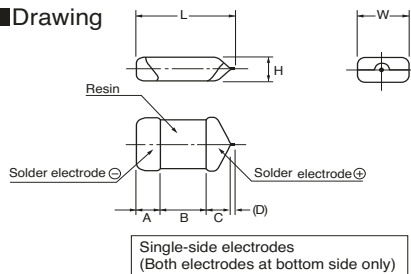

Dimensions

Case code	L	W	H	A	B	C	(D)
R	2.2 ± 0.3	1.25 ± 0.3	0.65MAX.	0.6 ± 0.3	0.8 ± 0.3	0.5MIN	(0.2)
P	2.2 ± 0.3	1.25 ± 0.3	1.0 ± 0.2	0.6 ± 0.3	0.8 ± 0.3	0.8 ± 0.3	(0.2)
Q	3.2 ± 0.2	1.6 ± 0.2	0.8 ± 0.2	0.8 ± 0.2	1.2 ± 0.2	0.8 ± 0.2	(0.2)
S	3.2 ± 0.3	1.6 ± 0.3	1.0 ± 0.2	0.8 ± 0.3	1.2 ± 0.3	0.8 ± 0.3	(0.2)
A	3.2 ± 0.3	1.7 ± 0.3	1.4 ± 0.2	0.8 ± 0.3	1.2 ± 0.3	0.8 ± 0.3	(0.2)
T	3.5 ± 0.2	2.7 ± 0.2	1.0 ± 0.2	0.8 ± 0.2	1.2 ± 0.2	1.1 ± 0.2	(0.2)
B	3.5 ± 0.2	2.8 ± 0.2	1.8 ± 0.2	0.8 ± 0.3	1.2 ± 0.3	1.1 ± 0.3	(0.2)

D dimension only for reference

Standard Ratings

Cap. (μF)	V	4	6.3	10	16	20	25	35
1	Code	0G	0J	1A	1C			
1.5	105							
2.2	155							
3.3	225					P	R · P	A
4.7	335							
6.8	475				R · P	S · A	P · Q · S · A	B
10	685						(Q) · (S)	
15	106			R · P	P · Q · S · A	S · A · B	A · (T) · B	
22	156			P	S · A			
33	226		R	P · Q · S · A	Q · S · A · T · B	B		
47	336		(R) · P	P · Q · S · A	(A) · T · B			
68	476	(R)	P	P · (Q) · S · A · T · B	B			
100	686		P	B				
150	107	P · S · A	P · Q · S · A · T · B	(S) · A · T · B				
220	157	P · B	B					
330	227	(P) · Q · S · A · T · B	(S) · (A) · (T) · B					
470	337	(P) · (S) · A · T · B	B					
680	477	(P) · (A) · (T) · B	(B)					
	687	(T)						

() The series in parentheses are being developed. Please contact to your local AVX sales office when these series are being designed in your application.

Specifications

Item	Performance Characteristics
Category	-55 to +125°C (Rated temperature : +85°C)
Temperature Range	
Capacitance Tolerance	±20%, ±10% (at 120Hz) (However R · P Case ±20%)
Dissipation Factor (at 120Hz)	Refer to next page
ESR(100kHz)	Refer to next page
Leakage Current	Refer to next page Provided that • After 1 minute's application of rated voltage, leakage current at 85°C, 10 times or less than 20°C specified value. • After 1 minute's application of rated voltage, leakage current at 125°C, 12.5 times or less than 20°C specified value.
Capacitance Change by Temperature	+15% Max. (at +125°C) +10% Max. (at +85°C) -10% Max. (at -55°C)
Damp Heat (Steady State)	At 40°C, 90 to 95% R.H., For 500 hours (No voltage applied) Capacitance Change Refer to next page (*1) Dissipation Factor Initial specified value or less Leakage Current Initial specified value or less
Temperature Cycles	At -55°C / +125°C, 30 minutes each, For 5 cycles, Capacitance Change Refer to next page (*1) Dissipation Factor Initial specified value or less Leakage Current Initial specified value or less
Resistance to Soldering Heat	10 seconds reflow at 260°C, 10 seconds immersion at 260°C Capacitance Change Refer to next page (*1) Dissipation Factor Initial specified value or less Leakage Current Initial specified value or less
Surge	After application of surge voltage in series with a 33Ω resistor at the rate of 30 seconds ON, 30 seconds OFF, for 1000 successive test cycles at 85°C, capacitors shall meet the characteristic requirements table below. Capacitance Change Refer to next page (*1) Dissipation Factor Initial specified value or less Leakage Current Initial specified value or less
Endurance	After 2000 hours' application of rated voltage at 85°C, capacitors shall meet the characteristic requirements table below. Capacitance Change Refer to next page (*1) Dissipation Factor Initial specified value or less Leakage Current Initial specified value or less
Shear Test	After applying the pressure load of 5N for 10 ± 1 seconds horizontally to the center of capacitor side body which has no electrode and has been soldered beforehand on a substrate, there shall be found neither exfoliation nor its sign at the terminal electrode. 5N (0.51kg · f) For 10 ± 1 seconds
Terminal Strength	Keeping a capacitor surface-mounted on a substrate upside down and supporting the substrate at both of the opposite bottom points 45mm apart from the center of capacitor, the pressure strength is applied with a specified jig at the center of substrate so that the substrate may bend by 1mm as illustrated. Then, there shall be found no remarkable abnormality on the capacitor terminals. R230 20 45 45 1mm



Standard Conformal Coated Chip

■ Standard Ratings

Rated Volt	Rated Capacitance (μF)	Case code	Part Number	*2 Leakage Current (μA)	Dissipation Factor (% @ 120Hz)	ESR (Ω @ 100kHz)	*1 ΔC/C (%)
4V	100	P	F950G107MPAAQ2	4.0	30	1.2	±15
	100	S	F950G107MSAAQ2	4.0	14	0.8	*
	100	A	F950G107MAAAQ2	4.0	12	0.5	*
	150	P	F950G157MPAAQ2	12.0	31	1.1	±20
	150	B	F950G157MBAAQ2	6.0	14	0.4	*
	220	Q	F950G227MQAAQ2	8.8	30	1.5	±20
	220	S	F950G227MSAAQ2	8.8	30	0.8	±15
	220	A	F950G227MAAAQ2	8.8	25	0.8	±15
	220	T	F950G227MTAAQ2	8.8	25	0.6	*
	220	B	F950G227MBAAQ2	8.8	16	0.4	*
	330	A	F950G337MAAAQ2	13.2	40	0.8	±20
	330	T	F950G337MTAAQ2	13.2	40	0.8	±20
	330	B	F950G337MBAAQ2	13.2	30	0.6	±15
	470	B	F950G477MBAAQ2	18.8	40	0.4	±20
6.3V	22	R	F950J226MRAAQ2	1.4	20	2.0	±20
	33	P	F950J336MPAAQ2	2.1	14	1.1	*
	47	P	F950J476MPAAQ2	3.0	20	1.1	±15
	68	P	F950J686MPAAQ2	4.3	25	1.2	±15
	100	P	F950J107MPAAQ2	12.6	35	1.2	±20
	100	Q	F950J107MQAAQ2	6.3	30	1.1	±20
	100	S	F950J107MSAAQ2	6.3	20	0.9	±15
	100	A	F950J107MAAAQ2	6.3	14	0.5	*
	100	T	F950J107MTAAQ2	6.3	14	0.6	*
	100	B	F950J107MBAAQ2	6.3	14	0.4	*
	150	B	F950J157MBAAQ2	9.5	18	0.4	*
	220	B	F950J227MBAAQ2	13.9	30	0.4	*
	330	B	F950J337MBAAQ2	20.8	35	0.6	±20
	10V	10	R	F951A106MRAAQ2	1.0	18	3.0
10		P	F951A106MPAAQ2	1.0	8	3.0	*
15		P	F951A156MPAAQ2	1.5	10	3.0	*
22		P	F951A226MPAAQ2	2.2	14	3.0	*
22		Q	F951A226MQAAQ2	2.2	10	2.0	*
22		S	F951A226MSAAQ2	2.2	10	1.1	*
22		A	F951A226MAAAQ2	2.2	6	0.9	*
33		P	F951A336MPAAQ2	3.3	20	3.0	±15
33		Q	F951A336MQAAQ2	3.3	18	3.0	±15
33		S	F951A336MSAAQ2	3.3	10	1.1	*
33		A	F951A336MAAAQ2	3.3	10	0.8	*
47		P	F951A476MPAAQ2	4.7	30	3.0	±20
47		S	F951A476MSAAQ2	4.7	14	1.1	±15
47		A	F951A476MAAAQ2	4.7	10	0.8	*
47		T	F951A476MTAAQ2	4.7	12	0.8	*
47		B	F951A476MBAAQ2	4.7	8	0.4	*
68		B	F951A686MBAAQ2	6.8	12	0.4	*
100		A	F951A107MAAAQ2	10.0	35	1.0	±15
100		T	F951A107MTAAQ2	10.0	20	0.6	±15
100		B	F951A107MBAAQ2	10.0	14	0.4	*

Rated Volt	Rated Capacitance (μF)	Case code	Part Number	*2 Leakage Current (μA)	Dissipation Factor (% @ 120Hz)	ESR (Ω @ 100kHz)	*1 ΔC/C (%)
16V	4.7	R	F951C475MRAAQ2	0.8	12	6.0	±20
	4.7	P	F951C475MPAAQ2	0.8	10	4.0	*
	10	P	F951C106MPAAQ2	1.6	10	4.0	*
	10	Q	F951C106MQAAQ2	1.6	8	3.0	*
	10	S	F951C106MSAAQ2	1.6	8	2.0	*
	10	A	F951C106MAAAQ2	1.6	6	1.4	*
	15	S	F951C156MSAAQ2	2.4	8	2.0	*
	15	A	F951C156MAAAQ2	2.4	8	1.4	*
	22	Q	F951C226MQAAQ2	3.5	12	3.0	*
	22	S	F951C226MSAAQ2	3.5	10	2.0	±15
	22	A	F951C226MAAAQ2	3.5	8	1.4	*
	22	T	F951C226MTAAQ2	3.5	8	1.4	*
	22	B	F951C226MBAAQ2	3.5	6	0.5	*
	33	T	F951C336MTAAQ2	5.3	11	1.5	±10
33	B	F951C336MBAAQ2	5.3	8	0.5	*	
47	B	F951C476MBAAQ2	7.5	10	0.6	*	
20V	2.2	P	F951D225MPAAQ2	0.5	6	6.0	*
	4.7	S	F951D475MSAAQ2	0.9	8	4.0	*
	4.7	A	F951D475MAAAQ2	0.9	6	1.5	*
	10	S	F951D106MSAAQ2	2.0	10	4.0	±10
	10	A	F951D106MAAAQ2	2.0	8	1.5	*
	10	B	F951D106MBAAQ2	2.0	6	0.8	*
25V	22	B	F951D226MBAAQ2	4.4	8	0.8	*
	1	R	F951E105MRAAQ2	0.5	10	10.0	±10
	2.2	R	F951E225MRAAQ2	0.6	15	15.0	±20
	2.2	P	F951E225MPAAQ2	0.6	8	6.0	±15
	4.7	P	F951E475MPAAQ2	1.2	10	8.0	±15
	4.7	Q	F951E475MQAAQ2	1.2	10	4.0	±15
	4.7	S	F951E475MSAAQ2	1.2	8	4.0	*
	4.7	A	F951E475MAAAQ2	1.2	8	2.0	*
10	A	F951E106MAAAQ2	2.5	12	2.0	±15	
10	B	F951E106MBAAQ2	2.5	6	0.9	*	
35V	1	P	F951V105MPAAQ2	0.5	8	10.0	±10
	1	S	F951V105MSAAQ2	0.5	6	8.0	*
	2.2	A	F951V225MAAAQ2	0.8	6	4.4	*
	4.7	B	F951V475MBAAQ2	1.7	6	1.6	*

* In case of capacitance tolerance ±10% type, [K] will be put at 9th digit of type numbering system.

1 : ΔC/C Marked ""

Item	P·Q·S·A·T·B Case (%)
Damp Heat	±10
Temperature cycles	±5
Resistance soldering heat	±5
Surge	±5
Endurance	±10

*2 : Leakage Current After 1 minute's application of rated voltage, leakage current at 20°C.

TAJ Series



Low Profile



- General purpose SMT chip tantalum series
- CV range: 0.10-1000 μ F / 2.5-50V
- 10 case sizes in low profile option available



CASE DIMENSIONS: millimeters (inches)

Code	EIA Code	EIA Metric	L \pm 0.20 (0.008)	W \pm 0.20 (0.008) -0.10 (0.004)	H Max.	W \pm 0.20 (0.008)	A \pm 0.30 (0.012) -0.20 (0.008)	S Min.
F	2312	6032-20	6.00 (0.236)	3.20 (0.126)	2.00 (0.079)	2.20 (0.087)	1.30 (0.051)	2.90 (0.114)
H	1210	3528-15	3.50 (0.138)	2.80 (0.110)	1.50 (0.059)	2.20 (0.087)	0.80 (0.031)	1.40 (0.055)
K	1206	3216-10	3.20 (0.126)	1.60 (0.063)	1.00 (0.039)	1.20 (0.047)	0.80 (0.031)	1.10 (0.043)
P	0805	2012-15	2.05 (0.081)	1.35 (0.053)	1.50 (0.059)	1.00 \pm 0.10 (0.039 \pm 0.004)	0.50 (0.020)	0.85 (0.033)
R	0805	2012-12	2.05 (0.081)	1.30 (0.051)	1.20 (0.047)	1.00 \pm 0.10 (0.039 \pm 0.004)	0.50 (0.020)	0.85 (0.033)
S	1206	3216-12	3.20 (0.126)	1.60 (0.063)	1.20 (0.047)	1.20 (0.047)	0.80 (0.031)	1.10 (0.043)
T	1210	3528-12	3.50 (0.138)	2.80 (0.110)	1.20 (0.047)	2.20 (0.087)	0.80 (0.031)	1.40 (0.055)
W	2312	6032-15	6.00 (0.236)	3.20 (0.126)	1.50 (0.059)	2.20 (0.087)	1.30 (0.051)	2.90 (0.114)
X	2917	7343-15	7.30 (0.287)	4.30 (0.169)	1.50 (0.059)	2.40 (0.094)	1.30 (0.051)	4.40 (0.173)
Y	2917	7343-20	7.30 (0.287)	4.30 (0.169)	2.00 (0.079)	2.40 (0.094)	1.30 (0.051)	4.40 (0.173)

W₁ dimension applies to the termination width for A dimensional area only.

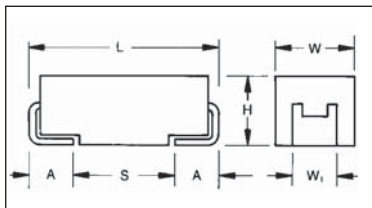

For part marking see page 151

HOW TO ORDER

TAJ	C	107	M	010	R	NJ	-
Type	Case Size See table above	Capacitance Code pF code: 1st two digits represent significant figures 3rd digit represents multiplier (number of zeros to follow)	Tolerance K= \pm 10% M= \pm 20%	Rated DC Voltage 002=2.5Vdc 004=4Vdc 006=6.3Vdc 010=10Vdc 016=16Vdc 020=20Vdc 025=25Vdc 035=35Vdc 050=50Vdc	Packaging R = Pure Tin 7" Reel S = Pure Tin 13" Reel A = Gold Plating 7" Reel B = Gold Plating 13" Reel	Specification Suffix NJ = Standard Suffix	Additional characters may be added for special requirements V = Dry pack Option (selected codes only)

TECHNICAL SPECIFICATIONS

Technical Data:	All technical data relate to an ambient temperature of +25°C									
Capacitance Range:	0.10 μ F to 1000 μ F									
Capacitance Tolerance:	\pm 10%; \pm 20%									
Rated Voltage (V _R)	\leq +85°C:	2.5	4	6.3	10	16	20	25	35	50
Category Voltage (V _C)	\leq +125°C:	1.7	2.7	4	7	10	13	17	23	33
Surge Voltage (V _S)	\leq +85°C:	3.3	5.2	8	13	20	26	32	46	65
Surge Voltage (V _S)	\leq +125°C:	2.2	3.4	5	8	13	16	20	28	40
Temperature Range:	-55°C to +125°C									
Reliability:	1% per 1000 hours at 85°C, V _R with 0.1 Ω /V series impedance, 60% confidence level									
Termination Finished:	Sn Plating (standard), Gold and SnPb Plating upon request									
	For AEC-Q200 availability, please contact AVX									



CAPACITANCE AND VOLTAGE RANGE, VR (VOLTAGE CODE) RANGE (LETTER DENOTES CASE SIZE)

Capacitance		Rated voltage DC (V _R) to 85°C								
µF	Code	2.5V (e)	4V (G)	6.3V (J)	10V (A)	16V (C)	20V (D)	25V (E)	35V (V)	50V (T)
0.10	104						R/S		R/S	S
0.15	154						R/S	R	R/S	S
0.22	224						R/S	R	R/S	P/R/S
0.33	334						R/S	R	R/S	P/R ^(M) /S/T
0.47	474						R/S	R/S	R/S/T	S/T
0.68	684					R/S	R/S/T	R/S	P/S/T	
1.0	105				R/S	R/S/T	R/S/T	P/R/S	P/S/T	W
1.5	155			R/S	R/S	R/S	P/R/S/T	P/S/T	T	W
2.2	225		R/S	R/S	R/S	R/S/T	P/R/S/T	T	T	
3.3	335		R/S	R/S	R/S/T	R/S/T	R/S/T	T	T/W	Y
4.7	475	R	R/S	R/S/T	R/S/T	R/S/T	K/P/S/T	T	T/W	Y
6.8	685	R	R/S/T	R/S/T	P/R/S/T	S/T	T	W	Y	Y
10	106	R/S	R/S/T	P/R/S/T	K/P/R ^(M) /S/T	T/W	W	W	X/Y	
15	156	R	R/S/T	K/P/R/S/T	S/T/W	T ^(M) /W	W	Y	Y	
22	226	P/R	K/P/R/S/T	K/P ^(M) /S/T/W	T/W	W	W/Y	Y	Y	
33	336	K/P/S	K/P ^(M) /S/T/W	T/W	W	W/Y	X/Y	Y		
47	476	P ^(M) /S	T/W	T/W	H/W/Y	W/X/Y	X/Y	Y		
68	686	T	T/W	W	W/Y	F/X/Y	Y			
100	107	T/W	T ^(M) /W	W/Y	W/X/Y	F ^(M) /Y				
150	157	T ^(M) /W	W/Y	W/X/Y	F/X ^(M) /Y	Y ^(M)				
220	227	W/Y	W/X/Y	F/X/Y	Y					
330	337	W ^(M) /Y	F/X/Y	Y						
470	477	F/Y	Y	Y						
680	687	Y	Y ^(M)							
1000	108	Y ^(M)								

Released codes ^(M tolerance only)

Engineering samples - please contact manufacturer

*Codes under development - subject to change

Note: Voltage ratings are minimum values. AVX reserves the right to supply higher ratings in the same case size, to the same reliability standards.

Low Profile

RATINGS & PART NUMBER REFERENCE

AVX Part No.	Case Size	Cap (µF)	Rated Voltage (V)	DCL (µA) Max.	DF % Max.	ESR Max. (Ω) @100kHz	MSL
2.5 Volt @ 85°C (1.7 Volt @ 125°C)							
TAJR475*002#NJ	R	4.7	2.5	0.5	6	20	1
TAJR685*002#NJ	R	6.8	2.5	0.5	6	20	1
TAJR106*002#NJ	R	10	2.5	0.5	8	4.5	1
TAJS106*002#NJ	S	10	2.5	0.5	6	8	1
TAJR156*002#NJ	R	15	2.5	0.5	8	4.1	1
TAJP226*002#NJ	P	22	2.5	0.5	8	3.5	1
TAJR226*002#NJ	R	22	2.5	0.5	8	3.8	1
TAJK336*002#NJ	K	33	2.5	0.8	8	1.7	1
TAJP336*002#NJ	P	33	2.5	0.7	8	3.5	1
TAJS336*002#NJ	S	33	2.5	0.7	8	1.5	1
TAJP476M002#NJ	P	47	2.5	1.2	12	3.2	1
TAJS476*002#NJ	S	47	2.5	1.2	8	1.6	1
TAJT686*002#NJ	T	68	2.5	1.4	8	1.5	1
TAJT107*002#NJ	T	100	2.5	2.5	15	1.3	1
TAJW107*002#NJ	W	100	2.5	2.5	8	0.4	1
TAJT157M002#NJ	T	150	2.5	3.8	18	1.2	1
TAJW157*002#NJ	W	150	2.5	3.8	8	0.3	1
TAJW227*002#NJ	W	220	2.5	5.5	8	0.3	1
TAJY227*002#NJ	Y	220	2.5	5.5	8	0.3	1 ¹⁾
TAJW337M002#NJ	W	330	2.5	8.2	12	0.3	1
TAJY337*002#NJ	Y	330	2.5	8.2	8	0.3	1 ¹⁾
TAJF477*002#NJ	F	470	2.5	11.8	12	0.3	1
TAJY477*002#NJ	Y	470	2.5	11	12	0.2	1 ¹⁾
TAJY687*002#NJ	Y	680	2.5	17	12	0.2	1 ¹⁾
TAJY108M002#NJ	Y	1000	2.5	25	30	0.2	1 ¹⁾
4 Volt @ 85°C (2.7 Volt @ 125°C)							
TAJR225*004#NJ	R	2.2	4	0.5	6	25	1
TAJS225*004#NJ	S	2.2	4	0.5	6	25	1
TAJR335*004#NJ	R	3.3	4	0.5	6	20	1
TAJS335*004#NJ	S	3.3	4	0.5	6	18	1
TAJR475*004#NJ	R	4.7	4	0.5	6	12	1
TAJS475*004#NJ	S	4.7	4	0.5	6	10	1
TAJR685*004#NJ	R	6.8	4	0.5	6	5.2	1
TAJS685*004#NJ	S	6.8	4	0.5	6	8	1
TAJT685*004#NJ	T	6.8	4	0.5	6	6	1
TAJR106*004#NJ	R	10	4	0.5	6	7	1
TAJS106*004#NJ	S	10	4	0.5	6	6	1
TAJT106*004#NJ	T	10	4	0.5	6	5	1
TAJR156*004#NJ	R	15	4	0.6	8	4	1
TAJS156*004#NJ	S	15	4	0.6	8	4	1
TAJT156*004#NJ	T	15	4	0.6	6	2	1
TAJK226*004#NJ	K	22	4	0.9	8	1.8	1
TAJP226*004#NJ	P	22	4	0.9	8	4	1
TAJR226*004#NJ	R	22	4	0.9	8	3.8	1
TAJS226*004#NJ	S	22	4	0.9	8	3.5	1
TAJT226*004#NJ	T	22	4	0.9	6	1.9	1
TAJK336*004#NJ	K	33	4	1.3	10	1.7	1
TAJP336M004#NJ	P	33	4	1.3	8	2.8	1
TAJS336*004#NJ	S	33	4	1.3	8	1.7	1
TAJT336*004#NJ	T	33	4	1.3	6	1.7	1
TAJW336*004#NJ	W	33	4	1.3	6	0.6	1
TAJT476*004#NJ	T	47	4	1.9	10	1.6	1
TAJW476*004#NJ	W	47	4	1.9	6	0.5	1
TAJT686*004#NJ	T	68	4	2.7	15	1.5	1
TAJW686*004#NJ	W	68	4	2.7	6	0.4	1
TAJT107M004#NJ	T	100	4	4	14	1.4	1
TAJW107*004#NJ	W	100	4	4	6	0.4	1
TAJW157*004#NJ	W	150	4	6	6	0.5	1
TAJY157*004#NJ	Y	150	4	6	6	0.4	1 ¹⁾
TAJW227*004#NJ	W	220	4	8.8	8	0.3	1
TAJX227*004#NJ	X	220	4	8.8	8	0.9	1 ¹⁾
TAJY227*004#NJ	Y	220	4	8.8	8	0.3	1 ¹⁾
TAJF337*004#NJ	F	330	4	13.2	10	0.3	1
TAJX337*004#NJ	X	330	4	13.2	8	0.3	1 ¹⁾

AVX Part No.	Case Size	Cap (µF)	Rated Voltage (V)	DCL (µA) Max.	DF % Max.	ESR Max. (Ω) @100kHz	MSL
TAJY337*004#NJ	Y	330	4	13.2	12	0.4	1 ¹⁾
TAJY477*004#NJ	Y	470	4	18.8	14	0.4	1 ¹⁾
TAJY687M004#NJ	Y	680	4	27.2	25	0.2	1 ¹⁾
6.3 Volt @ 85°C (4 Volt @ 125°C)							
TAJR155*006#NJ	R	1.5	6.3	0.5	6	25	1
TAJS155*006#NJ	S	1.5	6.3	0.5	6	25	1
TAJR225*006#NJ	R	2.2	6.3	0.5	6	20	1
TAJS225*006#NJ	S	2.2	6.3	0.5	6	18	1
TAJR335*006#NJ	R	3.3	6.3	0.5	6	12	1
TAJS335*006#NJ	S	3.3	6.3	0.5	6	9	1
TAJR475*006#NJ	R	4.7	6.3	0.5	6	7	1
TAJS475*006#NJ	S	4.7	6.3	0.5	6	7.5	1
TAJT475*006#NJ	T	4.7	6.3	0.5	6	6	1
TAJR685*006#NJ	R	6.8	6.3	0.5	8	7	1
TAJS685*006#NJ	S	6.8	6.3	0.5	6	2.6	1
TAJT685*006#NJ	T	6.8	6.3	0.5	6	5	1
TAJP106*006#NJ	P	10	6.3	0.6	8	6	1
TAJR106*006#NJ	R	10	6.3	0.6	8	6	1
TAJS106*006#NJ	S	10	6.3	0.6	8	4	1
TAJT106*006#NJ	T	10	6.3	0.6	6	4	1
TAJK156*006#NJ	K	15	6.3	0.9	6	2	1
TAJP156*006#NJ	P	15	6.3	0.9	8	3.5	1
TAJR156*006#NJ	R	15	6.3	0.9	8	4.1	1
TAJS156*006#NJ	S	15	6.3	0.9	8	3.5	1
TAJT156*006#NJ	T	15	6.3	0.9	6	3.5	1
TAJK226*006#NJ	K	22	6.3	1.3	10	1.8	1
TAJP226M006#NJ	P	22	6.3	1.3	8	3.3	1
TAJS226*006#NJ	S	22	6.3	1.3	10	1.8	1
TAJT226*006#NJ	T	22	6.3	1.4	8	2.5	1
TAJW226*006#NJ	W	22	6.3	1.3	6	0.6	1
TAJT336*006#NJ	T	33	6.3	2.1	10	2.5	1
TAJW336*006#NJ	W	33	6.3	2	6	0.5	1
TAJT476*006#NJ	T	47	6.3	2.8	10	1.6	1
TAJW476*006#NJ	W	47	6.3	2.8	6	0.5	1
TAJW686*006#NJ	W	68	6.3	4.3	6	1.5	1
TAJW107*006#NJ	W	100	6.3	6.3	6	0.9	1
TAJY107*006#NJ	Y	100	6.3	6.3	6	0.7	1 ¹⁾
TAJW157*006#NJ	W	150	6.3	9	8	0.3	1
TAJT157*006#NJ	X	150	6.3	9	6	0.4	1 ¹⁾
TAJY157*006#NJ	Y	150	6.3	9.5	6	0.4	1 ¹⁾
TAJF227*006#NJ	F	220	6.3	13.2	10	0.3	1
TAJX227*006#NJ	X	220	6.3	13.2	8	0.3	1 ¹⁾
TAJY227*006#NJ	Y	220	6.3	13.9	8	0.7	1 ¹⁾
TAJY337*006#NJ	Y	330	6.3	20.8	12	0.4	1 ¹⁾
TAJY477*006#NJ	Y	470	6.3	28.2	20	0.2	1 ¹⁾
10 Volt @ 85°C (7 Volt @ 125°C)							
TAJR105*010#NJ	R	1	10	0.5	4	25	1
TAJS105*010#NJ	S	1	10	0.5	4	25	1
TAJR155*010#NJ	R	1.5	10	0.5	6	20	1
TAJS155*010#NJ	S	1.5	10	0.5	6	20	1
TAJR225*010#NJ	R	2.2	10	0.5	6	15	1
TAJS225*010#NJ	S	2.2	10	0.5	6	12	1
TAJR335*010#NJ	R	3.3	10	0.5	6	8	1
TAJS335*010#NJ	S	3.3	10	0.5	6	8	1
TAJT335*010#NJ	T	3.3	10	0.5	6	6	1
TAJR475*010#NJ	R	4.7	10	0.5	6	9	1
TAJS475*010#NJ	S	4.7	10	0.5	6	5	1
TAJT475*010#NJ	T	4.7	10	0.5	6	5	1
TAJP685*010#NJ	P	6.8	10	0.6	6	5	1
TAJR685*010#NJ	R	6.8	10	0.7	6	5.2	1
TAJS685*010#NJ	S	6.8	10	0.7	6	4	1
TAJT685*010#NJ	T	6.8	10	0.7	6	4	1
TAJK106*010#NJ	K	10	10	1	6	2.2	1
TAJP106*010#NJ	P	10	10	1	8	6	1
TAJR106M010#NJ	R	10	10	1	20	6	1

¹⁾ Dry pack option (see How to order) recommended for reduction of stress during soldering. Dry pack parts should be treated as MSL 3.

Moisture Sensitivity Level (MSL) is defined according to J-STD-020.

All technical data relates to an ambient temperature of +25°C. Capacitance and DF are measured at 120Hz, 0.5V RMS with a maximum DC bias of 2.2 volts. DCL is measured at rated voltage after 5 minutes.

For typical weight and composition see page 144.

NOTE: AVX reserves the right to supply a higher voltage rating or tighter tolerance part in the same case size, to the same reliability standards.

TAJ Series



Low Profile

RATINGS & PART NUMBER REFERENCE

AVX Part No.	Case Size	Cap (µF)	Rated Voltage (V)	DCL (µA) Max.	DF % Max.	ESR Max. (Ω) @100kHz	MSL
TAJS106*010#NJ	S	10	10	1	8	3	1
TAJT106*010#NJ	T	10	10	1	6	3	1
TAJS156*010#NJ	S	15	10	1.5	6	2	1
TAJT156*010#NJ	T	15	10	1.5	8	2.8	1
TAJW156*010#NJ	W	15	10	1.5	6	0.7	1
TAJT226*010#NJ	T	22	10	2.2	8	2.2	1
TAJW226*010#NJ	W	22	10	2.2	6	0.6	1
TAJW336*010#NJ	W	33	10	3.3	6	1.6	1
TAJH476*006#NJ	H	47	10	4.7	8	1.0	1
TAJW476*010#NJ	W	47	10	4.7	6	1.4	1
TAJY476*010#NJ	Y	47	10	4.7	6	0.5	1 ¹⁾
TAJW686*010#NJ	W	68	10	6.8	6	1.2	1
TAJY686*010#NJ	Y	68	10	6.8	6	0.9	1 ¹⁾
TAJW107*010#NJ	W	100	10	10	6	0.4	1
TAJX107*010#NJ	X	100	10	10	8	0.9	1 ¹⁾
TAJY107*010#NJ	Y	100	10	10	6	0.9	1 ¹⁾
TAJF157*010#NJ	F	150	10	15	10	0.3	1
TAJX157M010#NJ	X	150	10	15	6	0.3	1 ¹⁾
TAJY157*010#NJ	Y	150	10	15	6	1.2	1 ¹⁾
TAJY227*010#NJ	Y	220	10	22	10	0.5	1 ¹⁾
16 Volt @ 85°C (10 Volt @ 125°C)							
TAJR684*016#NJ	R	0.68	16	0.5	4	25	1
TAJS684*016#NJ	S	0.68	16	0.5	4	25	1
TAJR105*016#NJ	R	1	16	0.5	4	20	1
TAJS105*016#NJ	S	1	16	0.5	4	15	1
TAJT105*016#NJ	T	1	16	0.5	4	5	1
TAJR155*016#NJ	R	1.5	16	0.5	6	10	1
TAJS155*016#NJ	S	1.5	16	0.5	6	12	1
TAJR225*016#NJ	R	2.2	16	0.5	6	6.5	1
TAJS225*016#NJ	S	2.2	16	0.5	6	6	1
TAJT225*016#NJ	T	2.2	16	0.5	6	6.5	1
TAJR335*016#NJ	R	3.3	16	0.5	8	5	1
TAJS335*016#NJ	S	3.3	16	0.5	6	5	1
TAJT335*016#NJ	T	3.3	16	0.5	6	5	1
TAJK475*016#NJ	K	4.7	16	0.8	6	3.1	1
TAJP475*016#NJ	P	4.7	16	0.8	8	5	1
TAJS475*016#NJ	S	4.7	16	0.8	8	4	1
TAJT475*016#NJ	T	4.7	16	0.8	6	3.1	1
TAJS685*016#NJ	S	6.8	16	1.1	8	2.4	1
TAJT685*016#NJ	T	6.8	16	1.1	6	3.5	1
TAJT106*016#NJ	T	10	16	1.6	8	2.2	1
TAJW106*016#NJ	W	10	16	1.6	6	2	1
TAJT156M016#NJ	T	15	16	2.4	6	2	1
TAJW156*016#NJ	W	15	16	2.4	6	0.7	1
TAJW226*016#NJ	W	22	16	3.5	6	1.6	1
TAJW336*016#NJ	W	33	16	5.3	6	1.5	1
TAJY336*016#NJ	Y	33	16	5.3	6	0.9	1 ¹⁾
TAJW476*016#NJ	W	47	16	7.5	6	0.4	1
TAJX476*016#NJ	X	47	16	7.5	6	0.75	1 ¹⁾
TAJY476*016#NJ	Y	47	16	7.5	6	0.7	1 ¹⁾
TAJF686*016#NJ	F	68	16	10.9	10	0.4	1
TAJX686*016#NJ	X	68	16	10.9	8	0.6	1 ¹⁾
TAJY686*016#NJ	Y	68	16	10.9	6	0.9	1 ¹⁾
TAJF107M016#NJ	F	100	16	16	10	0.4	1
TAJY107*016#NJ	Y	100	16	16	8	0.9	1 ¹⁾
TAJY157M016#NJ	Y	150	16	24	15	0.3	1 ¹⁾
20 Volt @ 85°C (13 Volt @ 125°C)							
TAJR104*020#NJ	R	0.1	20	0.5	4	25	1
TAJS104*020#NJ	S	0.1	20	0.5	4	25	1
TAJR154*020#NJ	R	0.15	20	0.5	4	25	1
TAJS154*020#NJ	S	0.15	20	0.5	4	25	1
TAJR224*020#NJ	R	0.22	20	0.5	4	25	1
TAJS224*020#NJ	S	0.22	20	0.5	4	25	1
TAJR334*020#NJ	R	0.33	20	0.5	4	25	1
TAJS334*020#NJ	S	0.33	20	0.5	4	25	1

AVX Part No.	Case Size	Cap (µF)	Rated Voltage (V)	DCL (µA) Max.	DF % Max.	ESR Max. (Ω) @100kHz	MSL
TAJR474*020#NJ	R	0.47	20	0.5	4	25	1
TAJS474*020#NJ	S	0.47	20	0.5	4	25	1
TAJR684*020#NJ	R	0.68	20	0.5	4	20	1
TAJS684*020#NJ	S	0.68	20	0.5	4	25	1
TAJT684*020#NJ	T	0.68	20	0.5	4	15	1
TAJR105*020#NJ	R	1	20	0.5	4	20	1
TAJS105*020#NJ	S	1	20	0.5	4	12	1
TAJT105*020#NJ	T	1	20	0.5	4	9	1
TAJP155*020#NJ	P	1.5	20	0.5	6	9.6	1
TAJR155*020#NJ	R	1.5	20	0.5	6	9.6	1
TAJS155*020#NJ	S	1.5	20	0.5	6	5.4	1
TAJT155*020#NJ	T	1.5	20	0.5	6	6.5	1
TAJP225*020#NJ	P	2.2	20	0.5	6	8.3	1
TAJR225*020#NJ	R	2.2	20	0.5	6	6	1
TAJS225*020#NJ	S	2.2	20	0.5	6	4.5	1
TAJT225*020#NJ	T	2.2	20	0.5	6	6	1
TAJT335*020#NJ	T	3.3	20	0.7	6	3	1
TAJT475*020#NJ	T	4.7	20	0.9	6	3.1	1
TAJT685*020#NJ	T	6.8	20	1.4	6	2.6	1
TAJW106*020#NJ	W	10	20	2	6	1.9	1
TAJW156*020#NJ	W	15	20	3	6	1.7	1
TAJW226*020#NJ	W	22	20	4.4	6	1.6	1
TAJY226*020#NJ	Y	22	20	4.4	6	0.9	1 ¹⁾
TAJX336*020#NJ	X	33	20	6.6	6	0.5	1 ¹⁾
TAJY336*020#NJ	Y	33	20	6.6	6	0.6	1 ¹⁾
TAJX476*020#NJ	X	47	20	9.4	6	0.4	1 ¹⁾
TAJY476*020#NJ	Y	47	20	9.4	6	0.9	1 ¹⁾
TAJY686*020#NJ	Y	68	20	13.6	6	0.9	1 ¹⁾
25 Volt @ 85°C (17 Volt @ 125°C)							
TAJR154*025#NJ	R	0.15	25	0.5	4	24	1
TAJR224*025#NJ	R	0.22	25	0.5	4	21	1
TAJR334*025#NJ	R	0.33	25	0.5	4	17	1
TAJR474*025#NJ	R	0.47	25	0.5	4	15	1
TAJS474*025#NJ	S	0.47	25	0.5	4	9	1
TAJR684*025#NJ	R	0.68	25	0.5	4	13	1
TAJS684*025#NJ	S	0.68	25	0.5	4	8	1
TAJP105*025#NJ	P	1	25	0.5	4	11	1
TAJR105*025#NJ	R	1	25	0.5	4	8	1
TAJS105*025#NJ	S	1	25	0.5	4	8	1
TAJP155*025#NJ	P	1.5	25	0.5	6	9.6	1
TAJS155*025#NJ	S	1.5	25	0.5	6	5.4	1
TAJT155*025#NJ	T	1.5	25	0.5	6	5	1
TAJT225*025#NJ	T	2.2	25	0.6	6	4.5	1
TAJT335*025#NJ	T	3.3	25	0.8	6	3.5	1
TAJW335*025#NJ	W	3.3	25	0.8	6	1.6	1
TAJT475*025#NJ	T	4.7	25	1.2	6	3.1	1
TAJW475*025#NJ	W	4.7	25	1.2	6	1.2	1
TAJW685*025#NJ	W	6.8	25	1.7	6	2	1
TAJW106*025#NJ	W	10	25	2.5	6	1.8	1
TAJY156*025#NJ	Y	15	25	3.8	6	1	1 ¹⁾
TAJY226*025#NJ	Y	22	25	5.5	6	0.8	1 ¹⁾
TAJY336*025#NJ	Y	33	25	8.3	6	0.5	1 ¹⁾
TAJY476*025#NJ	Y	47	25	11.8	6	0.9	1 ¹⁾
35 Volt @ 85°C (23 Volt @ 125°C)							
TAJR104*035#NJ	R	0.1	35	0.5	4	29	1
TAJS104*035#NJ	S	0.1	35	0.5	4	24	1
TAJR154*035#NJ	R	0.15	35	0.5	4	24	1
TAJS154*035#NJ	S	0.15	35	0.5	4	21	1
TAJR224*035#NJ	R	0.22	35	0.5	4	21	1
TAJS224*035#NJ	S	0.22	35	0.5	4	18	1
TAJR334*035#NJ	R	0.33	35	0.5	4	17	1
TAJS334*035#NJ	S	0.33	35	0.5	4	15	1
TAJR474*035#NJ	R	0.47	35	0.5	4	15	1
TAJS474*035#NJ	S	0.47	35	0.5	4	12	1
TAJT474*035#NJ	T	0.47	35	0.5	4	10	1

¹⁾ Dry pack option (see How to order) recommended for reduction of stress during soldering. Dry pack parts should be treated as MSL 3.

Moisture Sensitivity Level (MSL) is defined according to J-STD-020.

All technical data relates to an ambient temperature of +25°C. Capacitance and DF are measured at 120Hz, 0.5V RMS with a maximum DC bias of 2.2 volts. DCL is measured at rated voltage after 5 minutes.

For typical weight and composition see page 144.

NOTE: AVX reserves the right to supply a higher voltage rating or tighter tolerance part in the same case size, to the same reliability standards.



RATINGS & PART NUMBER REFERENCE

AVX Part No.	Case Size	Cap (µF)	Rated Voltage (V)	DCL (µA) Max.	DF % Max.	ESR Max. (Ω) @100kHz	MSL
TAJP684*035#NJ	P	0.68	35	0.5	4	13	1
TAJS684*035#NJ	S	0.68	35	0.5	4	8	1
TAJT684*035#NJ	T	0.68	35	0.5	4	8	1
TAJP105*035#NJ	P	1	35	0.5	4	11	1
TAJS105*035#NJ	S	1	35	0.5	4	7.5	1
TAJT105*035#NJ	T	1	35	5	4	6.5	1
TAJT155*035#NJ	T	1.5	35	0.5	6	5.2	1
TAJT225*035#NJ	T	2.2	35	0.8	6	4.2	1
TAJW335*035#NJ	W	3.3	35	1.2	6	1.6	1
TAJW475*035#NJ	W	4.7	35	1.6	6	2.2	1
TAJY685*035#NJ	Y	6.8	35	2.3	6	0.9	1 ¹⁾
TAJX106*035#NJ	X	10	35	3.5	6	0.7	1 ¹⁾
TAJY106*035#NJ	Y	10	35	3.5	6	1	1 ¹⁾
TAJY156*035#NJ	Y	15	35	5.3	6	0.6	1 ¹⁾
TAJY226*035#NJ	Y	22	35	7.7	6	0.5	1 ¹⁾
50 Volt @ 85°C (33 Volt @ 125°C)							
TAJS104*050#NJ	S	0.1	50	0.5	4	19	1
TAJS154*050#NJ	S	0.15	50	0.5	4	16	1
TAJP224*050#NJ	P	0.22	50	0.5	4	17	1
TAJR224*050#NJ	R	0.22	50	0.5	4	17	1
TAJS224*050#NJ	S	0.22	50	0.5	4	13	1
TAJP334*050#NJ	P	0.33	50	0.5	4	17	1
TAJR334*050#NJ	R	0.33	50	0.5	4	17	1
TAJS334*050#NJ	S	0.33	50	0.5	4	11	1
TAJT334*050#NJ	T	0.33	50	0.5	4	11	1
TAJS474*050#NJ	S	0.47	50	0.5	4	9.5	1
TAJT474*050#NJ	T	0.47	50	0.5	4	9.5	1
TAJW105*050#NJ	W	1	50	0.5	6	4.4	1
TAJW155*050#NJ	W	1.5	50	0.8	6	3.1	1
TAJY335*050#NJ	Y	3.3	50	1.7	4	1.5	1 ¹⁾
TAJY475*050#NJ	Y	4.7	50	2.4	6	1.2	1 ¹⁾
TAJY685*050#NJ	Y	6.8	50	3.4	6	0.9	1 ¹⁾

¹⁾ Dry pack option (see How to order) recommended for reduction of stress during soldering. Dry pack parts should be treated as MSL 3.

Moisture Sensitivity Level (MSL) is defined according to J-STD-020.

All technical data relates to an ambient temperature of +25°C. Capacitance and DF are measured at 120Hz, 0.5V RMS with a maximum DC bias of 2.2 volts. DCL is measured at rated voltage after 5 minutes.

For typical weight and composition see page 144.

NOTE: AVX reserves the right to supply a higher voltage rating or tighter tolerance part in the same case size, to the same reliability standards.

F92 Series



Resin-Molded Chip, Low Profile J-Lead



● Compliant to the RoHS directive (2002/95/EC).

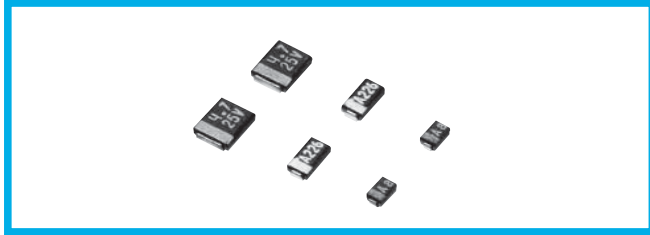

■ Type numbering system (Example: 6.3V 10μF)

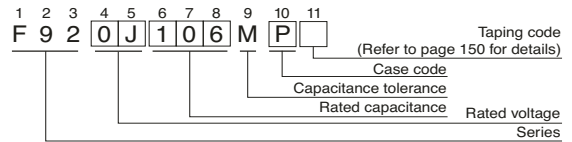

■ Drawing

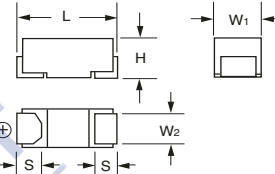

■ Dimensions

Case code	L	W ₁	W ₂	H	S
P	2.0 ± 0.2	1.25 ± 0.1	0.9 ± 0.1	1.1 ± 0.1	0.5 ± 0.2
A	3.2 ± 0.2	1.6 ± 0.2	1.2 ± 0.1	1.1 ± 0.1	0.8 ± 0.2
B	3.4 ± 0.2	2.8 ± 0.2	2.3 ± 0.1	1.1 ± 0.1	0.8 ± 0.2

■ Marking

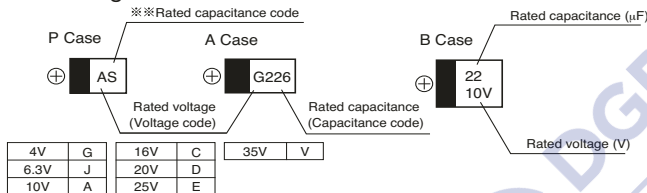

※ ※ Capacitance code of "P" case products are as shown below.

■ Specifications

Item	Performance Characteristics	
	P Case	A · B Case
Category	-55 to +125°C (Rated temperature : +85°C)	
Temperature Range	-55 to +125°C (Rated temperature : +85°C)	
Capacitance Tolerance	±20% (at 120Hz)	
Dissipation Factor (120Hz)	Refer to Next Page	
ESR (100kHz)	Refer to Next Page	
Leakage Current	<ul style="list-style-type: none"> After 1 minute's application of rated voltage, leakage current at 20°C is not more than 0.01CV or 0.5μA, whichever is greater. After 1 minute's application of rated voltage, leakage current at 85°C is not more than 0.1CV or 5μA, whichever is greater. After 1 minute's application of derated voltage, leakage current at 125°C is not more than 0.125CV or 6.3μA, whichever is greater. 	
Capacitance Change by Temperature	+20% Max. (at +125°C) +15% Max. (at +85°C) -15% Max. (at -55°C)	+15% Max. (at +125°C) +10% Max. (at +85°C) -10% Max. (at -55°C)
Damp Heat (Steady State)	At 40°C 90 to 95% R.H. 500 hours (No voltage applied) Capacitance Change... Refer to next page (*1) Dissipation Factor...150% or less than the initial specified value Leakage Current... Initial specified value or less	Refer to next page (*1) Initial specified value or less
Temperature Cycles	-55°C / +125°C 30 minutes each 5 cycles Capacitance Change... Refer to next page (*1) Dissipation Factor...150% or less than the initial specified value Leakage Current... Initial specified value or less	Refer to next page (*1) Initial specified value or less

Resistance to Soldering Heat	10 seconds reflow at 260°C, 5 seconds immersion at 260°C Capacitance Change... Refer to next page (*1) Dissipation Factor...150% of less than the initial specified value Leakage Current... Initial specified value or less	Refer to next page (*1) Initial specified value or less
Surge	After application of surge voltage in series with a 33Ω (For "P" case : 1kΩ) resistor at the rate of 30 seconds ON, 30 seconds OFF, for 1000 successive test cycles at 85°C, capacitors shall meet the characteristic requirements table below. Capacitance Change... Refer to next page (*1) Dissipation Factor...150% or less than the initial specified value Leakage Current... Initial specified value or less	Refer to next page (*1) Initial specified value or less
Endurance	After 2000hours' application of rated voltage in series with a 3Ω resistor at 85°C, or derated voltage in series with a 3Ω resistor at 125°C, capacitors shall meet the characteristic requirements table below. Capacitance Change... Refer to next page (*1) Dissipation Factor...150% or less than the initial specified value Leakage Current... Initial specified value or less	After 2000hours' application of rated voltage in series with a 3Ω resistor at 85°C, or derated voltage in series with a 3Ω resistor at 125°C, capacitors shall meet the characteristic requirements table below. Capacitance Change... Refer to next page (*1) Dissipation Factor... Initial specified value or less Leakage Current... Initial specified value or less
Shear Test	After applying the pressure load of 5N for 10±1 seconds horizontally to the center of capacitor side body which has no electrode and has been soldered beforehand on a substrate, there shall be found neither exfoliation nor its sign at the terminal electrode.	5N (0.51kg · f) For 10 ± 1 seconds
Terminal Strength	Keeping a capacitor surface-mounted on a substrate upside down and supporting the substrate at both of the opposite bottom points 45mm apart from the center of capacitor, the pressure strength is applied with a specified jig at the center of substrate so that the substrate may bend by 1mm as illustrated. Then, there shall be found no remarkable abnormality on the capacitor terminals.	R230 45 45 1mm

■ Standard Ratings

Cap. (μF)	Code	V		6.3	10	16	20	25	35	※ ※ Capacitance code
		4	6.3							
0.22	224		OG						A	J
0.33	334								A	N
0.47	474					P	P · A		A	S
0.68	684					P	A		A	W
1	105				P	P	P · A	P · A	A	A
1.5	155				P	P	A			E
2.2	225			P	P	P · A	(P) · A	A · B	B	J
3.3	335		P	P	P · A	A			B	N
4.7	475		P	P	P · A	(P) · A · B	A · B	A · B		S
6.8	685		P	P	P · A	B				w
10	106		P · A	P · A	P · A	A · B	B			a
15	156		P	P · A	A					e
22	226		P · A	P · A	A · B	B				J
33	336		P · A	A · B	B					n
47	476		(P) · A · B	A · B	B					s
68	686		A · B							
100	107		A · B	(A) · B						
150	157		B							
220	227		(B)							

() The series in parentheses are being developed. Please contact to your local AVX sales office when these series are being designed in your application.



F92 Series



Resin-Molded Chip, Low Profile J-Lead

Standard Ratings

Rated Volt	Rated Capacitance (μF)	Case code	Part Number	Leakage Current (μA)	Dissipation Factor (%@120Hz)	ESR (s@100kHz)	*1 ΔC/C (%)
4V	3.3	P	F920G335MPA	0.5	8	12.0	*
	4.7	P	F920G475MPA	0.5	8	6.0	*
	6.8	P	F920G685MPA	0.5	10	6.0	*
	10	P	F920G106MPA	0.5	10	6.0	*
	10	A	F920G106MAA	0.5	8	4.0	*
	15	P	F920G156MPA	0.6	10	5.0	*
	22	P	F920G226MPA	0.9	20	5.0	*
	22	A	F920G226MAA	0.9	12	2.8	*
	33	P	F920G336MPA	1.3	20	4.0	*
	33	A	F920G336MAA	1.3	12	2.8	*
	47	A	F920G476MAA	1.9	18	2.8	*
	47	B	F920G476MBA	1.9	12	1.7	*
	68	A	F920G686MAA	2.7	25	2.8	±15
	68	B	F920G686MBA	2.7	18	1.5	*
	100	A	F920G107MAA	4.0	30	2.8	±15
	100	B	F920G107MBA	4.0	18	1.3	*
150	B	F920G157MBA	6.0	25	1.3	±15	
6.3V	2.2	P	F920J225MPA	0.5	8	12.0	*
	3.3	P	F920J335MPA	0.5	8	12.0	*
	4.7	P	F920J475MPA	0.5	8	6.0	*
	6.8	P	F920J685MPA	0.5	10	6.0	*
	10	P	F920J106MPA	0.6	10	6.0	*
	10	A	F920J106MAA	0.6	8	4.0	*
	15	P	F920J156MPA	0.9	10	6.0	*
	15	A	F920J156MAA	0.9	8	4.0	*
	22	P	F920J226MPA	1.4	20	5.0	*
	22	A	F920J226MAA	1.4	12	2.8	*
	33	A	F920J336MAA	2.1	12	2.8	*
	33	B	F920J336MBA	2.1	12	1.7	*
	47	A	F920J476MAA	3.0	18	2.8	±15
	47	B	F920J476MBA	3.0	12	1.7	*
	100	B	F920J107MBA	6.3	20	1.3	±15
	10V	1	P	F921A105MPA	0.5	8	12.0
1.5		P	F921A155MPA	0.5	8	12.0	*
2.2		P	F921A225MPA	0.5	8	12.0	*
3.3		P	F921A335MPA	0.5	8	12.0	*
3.3		A	F921A335MAA	0.5	6	7.0	*
4.7		P	F921A475MPA	0.5	8	6.0	*
4.7		A	F921A475MAA	0.5	6	4.0	*
6.8		P	F921A685MPA	0.7	8	6.0	*
6.8		A	F921A685MAA	0.7	6	4.0	*
10		P	F921A106MPA	1.0	14	6.0	*
10		A	F921A106MAA	1.0	8	4.0	*
15		A	F921A156MAA	1.5	8	4.0	*
22		A	F921A226MAA	2.2	14	4.0	±15
22		B	F921A226MBA	2.2	8	1.9	*
33	B	F921A336MBA	3.3	12	1.9	*	
47	B	F921A476MBA	4.7	18	1.9	±15	
16V	0.47	P	F921C474MPA	0.5	8	20.0	*
	0.68	P	F921C684MPA	0.5	8	12.0	*
	1	P	F921C105MPA	0.5	8	12.0	*
	1.5	P	F921C155MPA	0.5	8	12.0	*
	2.2	P	F921C225MPA	0.5	8	12.0	*
	2.2	A	F921C225MAA	0.5	6	7.0	*
	3.3	A	F921C335MAA	0.5	6	7.0	*
	4.7	A	F921C475MAA	0.8	6	7.0	*
	4.7	B	F921C475MBA	0.8	6	3.0	*
	6.8	B	F921C685MBA	1.1	6	3.0	*
	10	A	F921C106MAA	1.6	8	7.0	±15
	10	B	F921C106MBA	1.6	6	2.0	*
22	B	F921C226MBA	3.5	12	2.0	±15	

Rated Volt	Rated Capacitance (μF)	Case code	Part Number	Leakage Current (μA)	Dissipation Factor (%@120Hz)	ESR (s@100kHz)	*1 ΔC/C (%)
20V	0.47	P	F921D474MPA	0.5	8	20.0	*
	0.47	A	F921D474MAA	0.5	4	10.0	*
	0.68	A	F921D684MAA	0.5	4	10.0	*
	1	P	F921D105MPA	0.5	8	20.0	*
	1	A	F921D105MAA	0.5	4	10.0	*
	1.5	A	F921D155MAA	0.5	6	7.4	*
	2.2	A	F921D225MAA	0.5	6	7.0	*
	4.7	A	F921D475MAA	0.9	10	7.0	±10
	4.7	B	F921D475MBA	0.9	6	3.0	*
	10	B	F921D106MBA	2.0	8	3.0	±10
25V	1	P	F921E105MPA	0.5	8	20.0	*
	1	A	F921E105MAA	0.5	6	10.0	*
	2.2	A	F921E225MAA	0.6	8	10.0	±15
	2.2	B	F921E225MBA	0.6	6	4.0	*
	4.7	A	F921E475MAA	1.2	10	7.0	±10
	4.7	B	F921E475MBA	1.2	6	3.0	*
35V	0.22	A	F921V224MAA	0.5	4	10.0	*
	0.33	A	F921V334MAA	0.5	4	10.0	*
	0.47	A	F921V474MAA	0.5	4	10.0	*
	1	A	F921V105MAA	0.5	6	10.0	*
	2.2	B	F921V225MBA	0.8	6	4.0	±10
	3.3	B	F921V335MBA	1.2	10	4.0	±10

1 : ΔC/C Marked ""

Item	P Case (%)	A , B Case(%)
Damp Heat	±20	±10
Temperature cycles	±10	± 5
Resistance soldering heat	±10	± 5
Surge	±10	± 5
Endurance	±10	±10

We can consider the type of compliance to AEC-Q200. Please contact to your local AVX sales office when these series are being designed in your application.

Low Profile

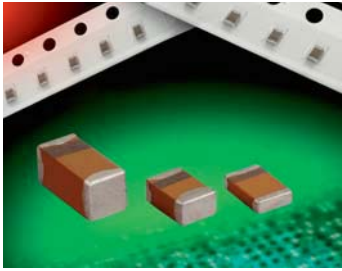

- The world's smallest surface mount tantalum capacitor
- CV range: 1.0-220µF / 2-16V
- 5 case sizes available in low profile option
- Industrial and hi-rel medical applications



CASE DIMENSIONS: millimeters (inches)

Code	EIA Code	EIA Metric	L+0.20 (0.008) -0.00 (0.000)	W+0.15 (0.006) -0.00 (0.000)	H max	Termination Spacing(S)	Minimum Termination Length (Lt)
H	0805	2012-10	2.00 (0.079)	1.35 (0.053)	1.00 (0.039)	0.70 (0.028) min	0.15 (0.006)
J	0603	1608-08	1.60 (0.063)	0.85 (0.033)	0.75 (0.030)	0.55 (0.022) min	0.15 (0.006)
T	1210	3528-12	3.50 ± 0.20 (0.138 ± 0.008)	2.80 ^{+0.20} _{-0.10} (0.110 ^{+0.008} _{-0.004})	1.20 (0.047)	2.00 (0.079) min	0.15 (0.006)
U	0805	2012-06	2.00 (0.079)	1.35 (0.053)	0.60 (0.024)	0.70 (0.028) min	0.15 (0.006)
V	1206	3216-08	3.20 ± 0.20 (0.126 ± 0.008)	1.60 ± 0.20 (0.063 ± 0.008)	0.75 (0.030)	1.80 (0.071) min	0.15 (0.006)

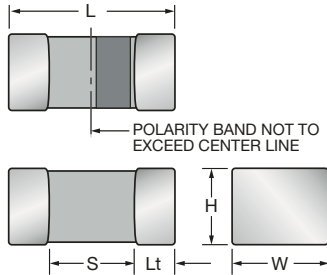

HOW TO ORDER

TAC	U	475	M	004	R	TA
Type TACmicrochip®	Case Size See table above	Capacitance Code pF code: 1st two digits represent significant figures, 3rd digit represents multiplier (number of zeros to follow)	Tolerance K=±10% M=±20%	Rated DC Voltage 002=2Vdc 003=3Vdc 004=4Vdc 006=6.3Vdc 010=10Vdc 016=16Vdc 035=35Vdc 050=50Vdc	Packaging R = 7" Standard Tin Termination Plastic Tape X = 4 1/4" Standard Tin Termination Plastic Tape A = 7" Gold Termination Plastic Tape F = 4 1/4" Gold Termination Plastic Tape	Alternative characters may be used for special requirements

TECHNICAL SPECIFICATIONS

Technical Data:	All technical data relate to an ambient temperature of +25°C									
Capacitance Range:	0.1 µF to 220 µF									
Capacitance Tolerance:	±10%; ±20%									
Leakage Current DCL:	0.01CV or 0.5µA whichever is the greater									
Rated Voltage (V _R)	≤ +85°C:	2	3	4	6.3	10	16	35	50	
Category Voltage (V _C)	≤ +125°C:	1.3	2	2.7	4	7	10	23	33	
Surge Voltage (V _S)	≤ +85°C:	2.7	3.9	5.2	8	13	20	46	65	
Surge Voltage (V _S)	≤ +125°C:	1.7	2.6	3.2	5	8	12	28	40	
Temperature Range:	-55°C to +125°C									
Reliability:	1% per 1000 hours at 85°C, V _R with 0.1Ω/V series impedance, 60% confidence level									
Termination Finish:	Nickel and Tin Plating (standard), Nickel and Gold Plating option available upon request									

Low Profile

LOW PROFILE & CUSTOM RANGE (LETTER DENOTES CASE SIZE)

Capacitance		Voltage Rating DC (V _R) at 85°C							
µF	Code	2.0V	3.0V	4.0V	6.3V	10V	16V	35V	50V
0.10	104								H*
0.15	154							H*	
0.22	224							H*	
0.33	334							H*	
0.47	474							H*	
0.68	684								
1.0	105						U ^(M)		
1.5	155								
2.2	225					U ^(M)			
3.3	335				U ^(M)				
4.7	475			U ^(M)					
6.8	685								
10	106	U ^(M)		J ^(M)		H/V			
15	156					H			
22	226					H			
33	336			H					
47	476		H ^(M)					T	
68	686								
100	107								
150	157								
220	227		T ^(M)						

Not recommended for new designs, higher voltage or smaller case size substitution are offered.

Released codes ^(M tolerance only)

Engineering samples - please contact manufacturer

*Codes under development - subject to change.

Standard Height Profile: A, B, K, L, R Case

Low Profile: H, J, T, U, V Case

Note: Voltage ratings are minimum values. AVX reserves the right to supply higher ratings in the same case size, to the same reliability standards.

RATINGS & PART NUMBER REFERENCE

AVX Part No.	EIA Code	EIA Metric	Case Size	Cap (µF)	Rated Voltage (V)	DCL (µA) Max.	DF % Max.	ESR Max. (Ω) @100kHz	MSL
2 Volt @ 85°C (1.3 Volt @ 125°C)									
TACU106M002#TA	0805	2012-06	U	10	2	0.5	8	5	1
3 Volt @ 40°C (2 Volt @ 125°C)									
TACH476M003#TA	0805	2012-10	H	47	3	1.4	20	5	1
TACT227M003#TA	1210	3528-12	T	220	3	6.6	20	1	1
4 Volt @ 85°C (2.7 Volt @ 125°C)									
TACU475M004#TA	0805	2012-06	U	4.7	4	0.5	8	5	1
TACJ106M004#TA	0603	1608-08	J	10	4	0.5	20	7.5	1
TACH336*004#TA	0805	2012-10	H	33	4	1.3	14	5	1
6.3 Volt @ 85°C (4 Volt @ 125°C)									
TACU335M006#TA	0805	2012-06	U	3.3	6.3	0.5	8	5	1
TACH156*006#TA	0805	2012-10	H	15	6.3	0.9	8	5	1
TACH226*006#TA	0805	2012-10	H	22	6.3	1.4	10	5	1
TACT686*006#TA	1210	3528-12	T	68	6.3	4.3	15	1	1
TACT107M006#TA	1210	3528-12	T	100	6.3	6.3	12	1	1
10 Volt @ 85°C (7 Volt @ 125°C)									
TACU225M010#TA	0805	2012-06	U	2.2	10	0.5	8	5	1
TACH106*010#TA	0805	2012-10	H	10	10	1.0	8	5	1
TACV106*010#TA	1206	3216-08	V	10	10	1.0	10	2	1
TACV156M010#TA	1206	3216-08	V	15	10	1.5	10	2	1
TACT476*010#TA	1210	3528-12	T	47	10	4.7	12	1	1
16 Volt @ 85°C (10 Volt @ 125°C)									
TACU105M016#TA	0805	2012-06	U	1	16	0.5	8	5	1

Moisture Sensitivity Level (MSL) is defined according to J-STD-020.

All technical data relates to an ambient temperature of +25°C. Capacitance and DF are measured at 120Hz, 0.5V RMS with a maximum DC bias of 2.2 volts. DCL is measured at rated voltage after 5 minutes.

For typical weight and composition see page 144.

NOTE: AVX reserves the right to supply a higher voltage rating or tighter tolerance part in the same case size, to the same reliability standards.

TLJ Series



Tantalum Solid Electrolytic Chip Capacitors High CV Consumer Series

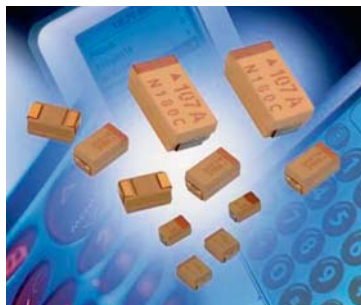

- High Volumetric Efficiency
- 3x reflow 260°C compatible
- 13 case sizes available including low profile codes
- Environmentally friendly
- Consumer applications (e.g. mobiles phones, PDA etc.)
- CV range: 10-680µF / 2.5-20V



LEAD-FREE
LEAD-FREE COMPATIBLE
COMPONENT

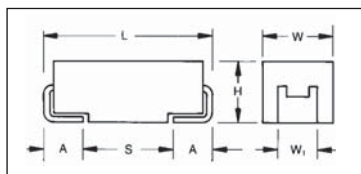

For part marking see page 151

CASE DIMENSIONS: millimeters (inches)

Code	EIA Code	EIA Metric	L±0.20 (0.008)	W+0.20 (0.008) -0.10 (0.004)	H+0.20 (0.008) -0.10 (0.004)	W±0.20 (0.008)	A+0.30 (0.012) -0.20 (0.008)	S Min.
A	1206	3216-18	3.20 (0.126)	1.60 (0.063)	1.60 (0.063)	1.20 (0.047)	0.80 (0.031)	1.10 (0.043)
B	1210	3528-21	3.50 (0.138)	2.80 (0.110)	1.90 (0.075)	2.20 (0.087)	0.80 (0.031)	1.40 (0.055)
F	2312	6032-20	6.00 (0.236)	3.20 (0.126)	2.00 (0.079) max.	2.20 (0.087)	1.30 (0.051)	2.90 (0.114)
G	1206	3216-15	3.20 (0.126)	1.60 (0.063)	1.50 (0.059) max	1.20 (0.047)	0.80 (0.031)	1.10 (0.043)
H	1210	3528-15	3.50 (0.138)	2.80 (0.110)	1.50 (0.059) max	2.20 (0.087)	0.80 (0.031)	1.40 (0.055)
K	1206	3216-10	3.20 (0.126)	1.60 (0.063)	1.00 (0.039) max	1.20 (0.047)	0.80 (0.031)	1.10 (0.043)
N	0805	2012-10	2.05 (0.081)	1.30 (0.051)	1.00 (0.039) max	1.00 (0.039)	0.50 (0.020)	0.85 (0.033)
P	0805	2012-15	2.05 (0.081)	1.35 (0.053)	1.50 (0.059) max	1.00±0.10 (0.039±0.004)	0.50 (0.020)	0.85 (0.033)
R	0805	2012-12	2.05 (0.081)	1.30 (0.051)	1.20 (0.047) max	1.00±0.10 (0.039±0.004)	0.50 (0.020)	0.85 (0.033)
S	1206	3216-12	3.20 (0.126)	1.60 (0.063)	1.20 (0.047) max	1.20 (0.047)	0.80 (0.031)	1.10 (0.043)
T	1210	3528-12	3.50 (0.138)	2.80 (0.110)	1.20 (0.047) max	2.20 (0.087)	0.80 (0.031)	1.40 (0.033)
W	2312	6032-15	6.00 (0.236)	3.20 (0.126)	1.50 (0.059) max	2.20 (0.087)	1.30 (0.051)	2.90 (0.114)
Y	2917	7343-20	7.30 (0.287)	4.30 (0.169)	2.00 (0.079) max	2.40 (0.094)	1.30 (0.051)	4.40 (0.173)

W1 dimension applies to the termination width for A dimensional area only.

HOW TO ORDER

TLJ

Type

W

Case Size
See table above

157

Capacitance Code
pF code: 1st two digits represent significant figures, 3rd digit represents multiplier (number of zeros to follow)

M

Tolerance
M = ±20%

010

Rated DC Voltage
002 = 2.5Vdc
004 = 4Vdc
006 = 6.3Vdc
010 = 10Vdc
016 = 16Vdc
020 = 20Vdc

R

Packaging
R = Pure Tin 7" Reel
S = Pure Tin 13" Reel

0200

ESR in mΩ

TECHNICAL SPECIFICATIONS

Technical Data:

All technical data relate to an ambient temperature of +25°C

Capacitance Range:

10 µF to 680 µF

Capacitance Tolerance:

±20%

Rated Voltage (V_R)

-55°C ≤ +40°C:

2.5

4

6.3

10

16

20

Category Voltage (V_C)

at 85°C:

1.25

2

3.15

5

8

10

Category Voltage (V_C)

at 125°C:

0.5

0.8

1.26

2

3.2

4

Temperature Range:

-55°C to +125°C with category voltage

Reliability:

0.2% per 1000 hours at 85°C, 0.5xV_R with 0.1Ω/V series impedance with 60% confidence level

TLJ Series



Tantalum Solid Electrolytic Chip Capacitors High CV Consumer Series

CAPACITANCE AND RATED VOLTAGE, VR (VOLTAGE CODE) RANGE (LETTER DENOTES CASE SIZE)

Capacitance		Rated Voltage DC to 40°C / 0.5DC to 85°C / 0.2DC to 125°C						
µF	Code	2.5V (e)	4V (G)	6.3V (J)	10V (A)	16V (C)	20V (D)	35V (V)
6.8	685							
10	106				N(2500) R(2000,3000)	S(2200)	T(1000)	
15	156				R(2000)			
22	226			N(5400)/R(3500)	K(1800)/N(3800) R(3800)	T(1000)		
33	336		N(8000)/R(3000)	K(1700)/N(8000) P(3000)/R(3000)	K(1500)/N(9600) P(3500) R(3500)/S(1500)	T(1000)		
47	476		K(1500)/N(4000) P(3000)/R(3000)	K(1500)/N(8300) P(700,900,1800,2500) R(3200)/S(1500)	A(600)/G(1500) P(3200)/R(3200) S(1500)/T(600)			
68	686		K(1200)/N(8000) P(3000) R(2900)/S(1500)	A(500)/G(800) S(1500)/T(600)	A(1500)			
100	107		A(500)/G(800) N(5200)/P(2700) S(1400)	A(500,800)/G(800) P(5400)/T(800)	A(1400) H(900)/T(900)			
150	157		A(800)/T(800)	A(900)/G(2500) H(900)/T(1200)	B(500) W(150,200)			
220	227	T(1100)	A(1100)/G(3000) H(900)/T(1100)	B(500)/T(2000) W(200)	F(300)			
330	337		T(2700)/W(200)	F(300)				
470	477							
680	687			Y(100,150)				
1000	108							
1500	158							

Available Ratings, (ESR ratings in mOhms in brackets)

Engineering samples - please contact manufacturer

*Codes under development - subject to change

Note: Voltage ratings are minimum values. AVX reserves the right to supply higher ratings in the same case size, to the same reliability standards.

TLJ Series



Tantalum Solid Electrolytic Chip Capacitors High CV Consumer Series

RATINGS & PART NUMBER REFERENCE

AVX Part No.	Case Size	Capacitance (µF)	Rated Voltage (V)	Maximum Surge Current (A)*	DCL (µA) Max.	ESR Max. (mΩ) @100kHz	MSL	100kHz Ripple Current (mA)			100kHz Ripple Voltage (mV)		
								25°C	85°C	125°C	25°C	85°C	125°C
2.5 Volt @ 40°C (1.25 Volt @ 85°C, 0.5 Volt @ 125°C)													
TLJT227M002#1200	T	220	2.5	0.8	5.5	1100	3	365	329	146	219	197	88
4 Volt @ 40°C (2 Volt @ 85°C, 0.8 Volt @ 125°C)													
TLJN336M004#8000	N	33	4	0.2	1.3	8000	3	79	71	32	632	569	253
TLJR336M004#3000	R	33	4	0.6	1.3	3000	3	135	122	54	406	366	162
TLJK476M004#1500	K	47	4	1.0	1.9	1500	3	208	187	83	312	281	125
TLJN476M004#4000	N	47	4	0.6	1.9	4000	3	112	101	45	447	402	179
TLJP476M004#3000	P	47	4	0.6	1.9	3000	3	141	127	57	424	382	170
TLJR476M004#3000	R	47	4	0.6	1.9	3000	3	135	122	54	406	366	162
TLJK686M004#1200	K	68	4	1.2	2.7	1200	3	233	209	93	279	251	112
TLJN686M004#8000	N	68	4	0.2	5.4	8000	3	79	71	32	632	569	253
TLJP686M004#3000	P	68	4	1.2	2.7	3000	3	141	127	57	424	382	170
TLJR686M004#2900	R	68	4	0.6	2.7	2900	3	138	124	55	399	359	160
TLJS686M004#1500	S	68	4	1.0	2.7	1500	3	208	187	83	312	281	125
TLJA107M004#0500	A	100	4	2.1	4.0	500	3	387	349	155	194	174	77
TLJG107M004#0800	G	100	4	1.6	4.0	800	3	296	266	118	237	213	95
TLJN107M004#5200	N	100	4	0.4	8.0	5200	3	98	88	39	510	459	204
TLJP107M004#2700	P	100	4	0.6	8.0	2700	3	149	134	60	402	362	161
TLJS107M004#1400	S	100	4	1.1	4.0	1400	3	208	187	83	312	281	125
TLJA157M004#0800	A	150	4	1.6	6.0	800	3	306	276	122	245	220	98
TLJT157M004#0800	T	150	4	1.6	6.0	800	3	316	285	126	253	228	101
TLJA227M004#1100	A	220	4	1.3	17.6	1100	3	261	235	104	287	259	115
TLJG227M004#3000	G	220	4	0.6	17.6	3000	3	153	137	61	458	412	183
TLJH227M004#0900	H	220	4	1.5	8.8	900	3	298	268	119	268	241	107
TLJT227M004#1100	T	220	4	1.3	17.6	1100	3	316	285	126	253	228	101
TLJT337M004#2700	T	330	4	0.6	26.4	2700	3	172	155	69	465	418	186
TLJW337M004#0200	W	330	4	3.1	13.2	200	3	671	604	268	134	121	54
6.3 Volt @ 40°C (3.15 Volt @ 85°C, 1.26 Volt @ 125°C)													
TLJN226M006#5400	N	22	6.3	0.5	1.3	5400	3	96	87	38	520	468	208
TLJR226M006#3500	R	22	6.3	0.8	1.3	3500	3	125	113	50	439	395	175
TLJK336M006#1700	K	33	6.3	1.5	2.0	1700	3	196	176	78	332	299	133
TLJN336M006#8000	N	33	6.3	0.4	2.0	8000	3	79	71	32	632	569	253
TLJP336M006#3000	P	33	6.3	0.9	2.0	3000	3	141	127	57	424	382	170
TLJR336M006#3000	R	33	6.3	0.9	2.0	3000	3	135	122	54	406	366	162
TLJK476M006#1500	K	47	6.3	1.6	2.8	1500	3	208	187	83	312	281	125
TLJN476M006#8300	N	47	6.3	0.4	5.6	8300	3	78	70	31	644	580	258
TLJP476M006#0700	P	47	6.3	2.7	2.8	700	3	293	263	117	205	184	82
TLJP476M006#0900	P	47	6.3	2.3	2.8	900	3	258	232	103	232	209	93
TLJP476M006#1800	P	47	6.3	1.4	2.8	1800	3	183	164	73	329	296	131
TLJP476M006#2500	P	47	6.3	1.1	2.8	2500	3	155	139	62	387	349	155
TLJR476M006#3200	R	47	6.3	0.9	2.8	3200	3	131	118	52	420	378	168
TLJS476M006#1500	S	47	6.3	1.6	2.8	1500	3	208	187	83	312	281	125
TLJA686M006#0500	A	68	6.3	3.3	4.1	500	3	387	349	155	194	174	77
TLJG686M006#0800	G	68	6.3	1.9	4.1	800	3	242	217	97	290	261	116
TLJS686M006#1500	S	68	6.3	1.6	4.1	1500	3	208	187	83	312	281	125
TLJT686M006#0600	T	68	6.3	3.0	4.1	600	3	365	329	146	219	197	88
TLJA107M006#0500	A	100	6.3	3.3	6.0	500	3	387	349	155	194	174	77
TLJA107M006#0800	A	100	6.3	2.5	6.0	800	3	306	276	122	245	220	98
TLJG107M006#0800	G	100	6.3	2.5	6.0	800	3	296	266	118	237	213	95
TLJP107M006#5400	P	100	6.3	0.5	12.0	5400	3	105	95	42	596	512	228
TLJT107M006#0800	T	100	6.3	2.5	6.0	800	3	316	285	126	253	228	101
TLJA157M006#0900	A	150	6.3	2.3	9.0	900	3	289	260	115	260	234	104
TLJG157M006#2500	G	150	6.3	1.1	18.0	2500	3	167	151	67	418	376	167
TLJH157M006#0900	H	150	6.3	2.3	9.0	900	3	298	268	119	268	241	107
TLJT157M006#1200	T	150	6.3	1.9	9.0	1200	3	316	285	126	253	228	101
TLJB227M006#0500	B	220	6.3	3.3	13.2	500	3	412	371	165	206	186	82
TLJT227M006#2000	T	220	6.3	1.3	26.4	2000	3	200	180	80	400	360	160
TLJW227M006#0200	W	220	6.3	4.8	13.2	200	3	671	604	268	134	121	54
TLJF337M006#0300	F	330	6.3	4.2	19.8	300	3	577	520	231	173	156	69
TLJY687M006#0100	Y	680	6.3	5.7	40.8	100	3	1118	1006	447	112	101	45
TLJY687M006#0150	Y	680	6.3	5.7	40.8	150	3	913	822	365	137	123	55

Moisture Sensitivity Level (MSL) is defined according to J-STD-020.

All technical data relates to an ambient temperature of +25°C. Capacitance and DF are measured at 120Hz, 0.5V RMS with a maximum DC bias of 2.2 volts. DCL is measured at rated voltage after 5 minutes.

ESR allowed to move up to 1.25 times catalogue limit post mounting
DCL allowed to move up to 2.00 times catalogue limit post mounting

For typical weight and composition see page 144.

NOTE: AVX reserves the right to supply a higher voltage rating or tighter tolerance part in the same case size, to the same reliability standards.



TLJ Series



Tantalum Solid Electrolytic Chip Capacitors High CV Consumer Series

RATINGS & PART NUMBER REFERENCE

AVX Part No.	Case Size	Capacitance (µF)	Rated Voltage (V)	Maximum Surge Current (A)*	DCL (µA) Max.	ESR Max. (mΩ) @100kHz	MSL	100kHz Ripple Current (mA)			100kHz Ripple Voltage (mV)		
								25°C	85°C	125°C	25°C	85°C	125°C
10 Volt @ 40°C (5 Volt @ 85°C, 2 Volt @ 125°C)													
TLJN106M010#2500	N	10	10	1.7	1.0	2500	3	141	127	57	354	318	141
TLJR106M010#2000	R	10	10	2.0	1.0	2000	3	166	149	66	332	298	133
TLJR106M010#3000	R	10	10	1.4	1.0	3000	3	135	122	54	406	366	162
TLJR156M010#2000	R	15	10	2.0	1.5	2000	3	166	149	66	332	298	133
TLJK226M010#1800	K	22	10	2.2	2.2	1800	3	190	171	76	342	308	137
TLJN226M010#3800	N	22	10	1.2	2.2	3800	3	115	103	46	436	392	174
TLJR226M010#3800	R	22	10	1.2	2.2	3800	3	120	108	48	457	411	183
TLJK336M010#1500	K	33	10	2.6	3.3	1500	3	208	187	83	312	281	125
TLJN336M010#9600	N	33	10	0.5	6.6	9600	3	72	65	29	693	624	277
TLJP336M010#3500	P	33	10	1.3	3.3	3500	3	141	127	57	424	382	170
TLJR336M010#3500	R	33	10	1.3	3.3	3500	3	125	113	50	439	395	175
TLJS336M010#1500	S	33	10	2.6	3.3	1500	3	208	187	83	312	281	125
TLJA476M010#0600	A	47	10	4.8	4.7	600	3	354	318	141	212	191	85
TLJG476M010#1500	G	47	10	2.6	4.7	1500	3	216	194	86	324	292	130
TLJP476M010#3200	P	47	10	1.4	4.7	3200	3	137	123	55	438	394	175
TLJR476M010#3200	R	47	10	1.4	9.4	3200	3	131	118	52	420	378	168
TLJS476M010#1500	S	47	10	2.6	4.7	1500	3	208	187	83	312	281	125
TLJT476M010#0600	T	47	10	4.8	4.7	600	3	365	329	146	219	197	88
TLJA686M010#1500	A	68	10	2.6	6.8	1500	3	224	201	89	335	302	134
TLJA107M010#1400	A	100	10	2.7	10.0	1400	3	231	208	93	324	292	130
TLJH107M010#0900	H	100	10	3.7	10.0	900	3	298	268	119	268	241	107
TLJT107M010#0900	T	100	10	3.7	10.0	900	3	298	268	119	268	241	107
TLJB157M010#0500	B	150	10	5.3	15.0	500	3	412	371	165	206	186	82
TLJW157M010#0150	W	150	10	8.3	15.0	150	3	775	697	310	116	105	46
TLJW157M010#0200	W	150	10	7.7	15.0	200	3	671	604	268	134	121	54
TLJF227M010#0300	F	220	10	6.7	22.0	300	3	577	520	231	173	156	69
16 Volt @ 40°C (8 Volt @ 85°C, 3.2 Volt @ 125°C)													
TLJS106M016#2200	S	10	16	3.0	1.6	2200	3	172	155	69	378	340	151
TLJT226M016#1000	T	22	16	5.5	3.5	1000	3	283	255	113	283	255	113
TLJT336M016#1000	T	33	16	5.5	5.3	1000	3	283	255	113	283	255	113
20 Volt @ 40°C (10 Volt @ 85°C, 4 Volt @ 125°C)													
TLJT106M020#1000	T	10	20	6.9	2.0	1000	3	283	255	113	283	255	113

Moisture Sensitivity Level (MSL) is defined according to J-STD-020.

All technical data relates to an ambient temperature of +25°C. Capacitance and DF are measured at 120Hz, 0.5V RMS with a maximum DC bias of 2.2 volts. DCL is measured at rated voltage after 5 minutes.

ESR allowed to move up to 1.25 times catalogue limit post mounting
DCL allowed to move up to 2.00 times catalogue limit post mounting

For typical weight and composition see page 144.

NOTE: AVX reserves the right to supply a higher voltage rating or tighter tolerance part in the same case size, to the same reliability standards.

Voltage vs Temperature Rating

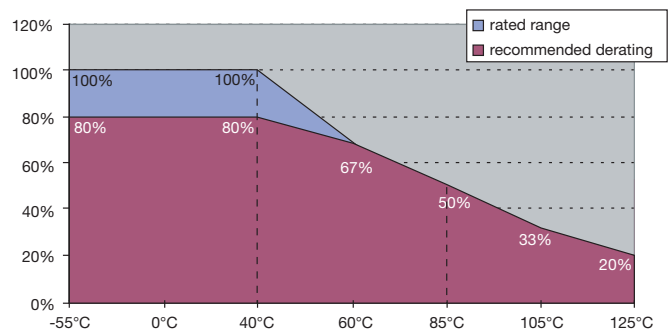

TLC Series



Tantalum Solid Electrolytic Chip Capacitors Consumer Series



- High capacitance vs. voltage ratio
- Super high volumetric efficiency
- CV range: 0.47-220 μ F / 2-35V
- 10 case sizes available
- Consumer applications (portable hand-held electronics, cellular phones, digital equipments etc.)



SnPb termination option is not RoHS compliant.

CASE DIMENSIONS: millimeters (inches)

Code	EIA Code	EIA Metric	L+0.20 (0.008) -0.00 (0.000)	W+0.15 (0.006) -0.00 (0.000)	H+0.15 (0.006) -0.00 (0.000)	Termination Spacing(S)	Minimum Termination Length (Lt)
A	1206	3216-18	3.20 \pm 0.20 (0.126 \pm 0.008)	1.60 \pm 0.20 (0.063 \pm 0.008)	1.60 \pm 0.20 (0.063 \pm 0.008)	1.80 (0.071) min	0.15 (0.006)
C	1206	3216-10	3.20 \pm 0.20 (0.126 \pm 0.008)	1.60 \pm 0.20 (0.063 \pm 0.008)	1.00 (0.039) max	1.80 (0.071) min	0.15 (0.006)
H	0805	2012-10	2.00 (0.079)	1.35 (0.053)	1.00 (0.039) max	0.70 (0.028) min	0.15 (0.006)
J	0603	1608-08	1.60 (0.063)	0.85 (0.033)	0.75 (0.030) max	0.55 (0.022) min	0.15 (0.006)
K	0402	1005-07	1.00 (0.039)	0.50 $^{+0.20}_{-0.00}$ (0.020 $^{+0.008}_{-0.000}$)	0.50 $^{+0.20}_{-0.00}$ (0.020 $^{+0.008}_{-0.000}$)	0.40 (0.016) min	0.10 (0.004)
L	0603	1608-10	1.60 (0.063)	0.85 (0.033)	0.85 (0.033)	0.55 (0.022) min	0.15 (0.006)
M	0803	2008-10	2.00 (0.079)	0.85 (0.033)	0.85 (0.033)	0.70 (0.028) min	0.15 (0.006)
N	0402	1005-05	1.00 \pm 0.05 (0.039 \pm 0.002)	0.50 $^{+0.00}_{-0.10}$ (0.020 $^{+0.000}_{-0.004}$)	0.50 $^{+0.00}_{-0.10}$ (0.020 $^{+0.000}_{-0.004}$)	0.40 (0.016) min	0.10 (0.004)
Q	0805	2012-12	2.00 (0.079)	1.35 (0.053)	1.20 (0.047) max	0.70 (0.028) min	0.15 (0.006)
R	0805	2012-15	2.00 (0.079)	1.35 (0.053)	1.35 (0.053)	0.70 (0.028) min	0.15 (0.006)
S	1206	3216-12	3.20 \pm 0.20 (0.126 \pm 0.008)	1.60 \pm 0.20 (0.063 \pm 0.008)	1.20 (0.047) max	1.80 (0.071) min	0.15 (0.006)
T	1210	3528-12	3.50 \pm 0.20 (0.138 \pm 0.008)	2.80 $^{+0.20}_{-0.10}$ (0.110 $^{+0.008}_{-0.004}$)	1.20 (0.047) max	2.00 (0.079) min	0.15 (0.006)
U	0805	2012-06	2.00 (0.079)	1.35 (0.053)	0.60 (0.024) max	0.70 (0.028) min	0.15 (0.006)
V	1206	3216-08	3.20 \pm 0.20 (0.126 \pm 0.008)	1.60 \pm 0.20 (0.063 \pm 0.008)	0.75 (0.030) max	1.80 (0.071) min	0.15 (0.006)
Z	0602	1605-07	1.60 (0.063)	0.50 $^{+0.20}_{-0.00}$ (0.020 $^{+0.008}_{-0.000}$)	0.50 $^{+0.20}_{-0.00}$ (0.020 $^{+0.008}_{-0.000}$)	0.55 (0.022) min	0.15 (0.006)

Under development

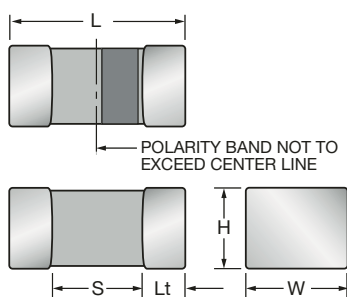

TLC Series



Tantalum Solid Electrolytic Chip Capacitors Consumer Series

HOW TO ORDER

TLC	L	226	M	006	R	TA
Type	Case Size See table above	Capacitance Code pF code: 1st two digits represent significant figures, 3rd digit represents multiplier (number of zeros to follow)	Tolerance M=±20%	Rated DC Voltage 002=2Vdc 003=3Vdc 004=4Vdc 006=6.3Vdc 008=8Vdc 010=10Vdc 016=16Vdc 020=20Vdc 025=25Vdc 035=35Vdc 050=50Vdc	Packaging R, P = 7" Standard Tin Termination Plastic Tape X, Q = 4 1/4" Standard Tin Termination Plastic Tape A = 7" Gold Termination Plastic Tape F = 4 1/4" Gold Termination Plastic Tape	Standard Suffix OR 4000 ESR in mΩ

TECHNICAL SPECIFICATIONS

Technical Data:	All technical data relate to an ambient temperature of +25°C											
Capacitance Range:	0.33 μF to 470 μF											
Capacitance Tolerance:	±20%											
Rated Voltage (V _R)	-55°C ≤ +40°C:	2	3	4	6.3	8	10	16	20	25	35	50
Category Voltage (V _C)	at 85°C:	1	1.5	2	3.2	4	5	8	10	12.5	17.5	25
Category Voltage (V _C)	at 125°C:	0.4	0.6	0.8	1.3	1.6	2	3.2	4	5	7	10
Temperature Range:	-55°C to +125°C with category voltage											
Reliability:	0.2% per 1000 hours at 85°C, 0.5xV _R with 0.1Ω/V series impedance with 60% confidence level											

CAPACITANCE AND RATED VOLTAGE, VR (VOLTAGE CODE) RANGE (LETTER DENOTES CASE SIZE)

Capacitance		Voltage Rating DC (V _R) to 40°C										
μF	Code	2.0V	3.0V	4.0V	6.3V	8V	10V	16V	20V	25V	35V	50V
0.33	334						N*	J*		L*		
0.47	474							K				
0.68	684											
1.0	105							J*/K	J*	L	L*/R	R*
1.5	155											
2.2	225						J*/K	J*	H/L*	H/R		
3.3	335							L				
4.7	475			K/N*	K/U		J/K*				R*	
6.8	685		K	K			U					
10	106		K	J/K/Z	J/K/Z		J*/K*/U/Z*	V	R		A*	
15	156	K	K*	K/Z*			H/L					
22	226	J	J	J*/U	L/U		L/M			T*		
33	336			L/U	H/L/L(4000)/U/V	L	H/M*					
47	476	L	L	H/L	H/L*/V		C*/H*/L*/Q*/R/V*					
68	686			R	R		A*/R*					
100	107		H*	C*/H*/Q*/R	H*/R/V*		R*/T					
150	157			R*	R*		A*					
220	227	R*	S*	A*/R*/T	A*		T*					
330	337			A*	T*							
470	477	A*		A*/T*								
680	687											

Released Codes

Engineering samples - please contact manufacturer

*Codes under development - subject to change.

Note: Voltage ratings are minimum values. AVX reserves the right to supply higher ratings in the same case size, to the same reliability standards.



TLC Series



Tantalum Solid Electrolytic Chip Capacitors Consumer Series

RATINGS & PART NUMBER REFERENCE

AVX Part No.	EIA Code	EIA Metric	Case Size	Cap (µF)	Rated Voltage (V)	DCL (µA) Max.	ESR Max. (Ω) @100kHz	MSL
2 Volt @ 40°C (1 Volt @ 85°C, 0.4 Volt @ 125°C)								
TLCCK156M002#TA	0402	1005-07	K	15	2	0.5	15	3
TLCJ226M002#TA	0603	1608-08	J	22	2	0.5	7.5	3
TLCCL476M002#TA	0603	1608-10	L	47	2	0.9	7.5	3
TLCRC227M002#TA	0805	2012-15	R	220	2	4.4	5	3
TLCAC477M002#TA	1206	3216-18	A	470	2	9.4	1	3
3 Volt @ 40°C (1.5 Volt @ 85°C, 0.6 Volt @ 125°C)								
TLCCK685M003#TA	0402	1005-07	K	6.8	3	0.5	15	3
TLCCK106M003#TA	0402	1005-07	K	10	3	0.5	15	3
TLCCK156M003#TA	0402	1005-07	K	15	3	0.5	15	3
TLCJ226M003#TA	0603	1608-08	J	22	3	0.7	7.5	3
TLCJ476M003#TA	0603	1608-10	L	47	3	1.4	7.5	3
TLCH107M003#TA	0805	2012-10	H	100	3	3.0	5	3
TLCSC227M003#TA	1206	3216-12	S	220	3	6.6	2	3
4 Volt @ 40°C (2 Volt @ 85°C, 0.8 Volt @ 125°C)								
TLCCK475M004#TA	0402	1005-07	K	4.7	4	0.5	15	3
TLCN475M004#TA	0402	1005-05	N	4.7	4	0.5	20	3
TLCCK685M004#TA	0402	1005-07	K	6.8	4	0.5	15	3
TLCJ106M004#TA	0603	1608-08	J	10	4	0.5	7.5	3
TLCJ106M004#TA	0402	1005-07	K	10	4	0.5	15	3
TLCZ106M004#TA	0602	1605-07	Z	10	4	0.5	15	3
TLCCK156M004#TA	0402	1005-07	K	15	4	3.0	15	3
TLCJ226M004#TA	0602	1605-07	Z	22	4	0.9	12	3
TLCJ226M004#TA	0603	1608-08	J	22	4	0.9	12	3
TLCJ226M004#TA	0805	2012-06	U	22	4	0.9	12	3
TLCJ336M004#TA	0603	1608-10	L	33	4	1.3	7.5	3
TLCJ336M004#TA	0805	2012-06	U	33	4	2.6	9	3
TLCJ476M004#TA	0805	2012-10	H	47	4	1.9	5	3
TLCJ476M004#TA	0603	1608-10	L	47	4	1.9	7.5	3
TLCR686M004#TA	0805	2012-15	R	68	4	2.7	5	3
TLCR107M004#TA	1205	3216-10	C	100	4	4.0	2	3
TLCR107M004#TA	0805	2012-10	H	100	4	4.0	5	3
TLCQ107M004#TA	0805	2012-12	Q	100	4	4.0	5	3
TLCR107M004#TA	0805	2012-15	R	100	4	4.0	5	3
TLCR157M004#TA	0805	2012-15	R	150	4	6.0	5	3
TLCR227M004#TA	1206	3216-18	A	220	4	8.8	1	3
TLCR227M004#TA	0805	2012-15	R	220	4	8.8	5	3
TLCR227M004#TA	1210	3528-12	T	220	4	8.8	1	3
TLCAC477M004#TA	1206	3216-18	A	470	4	18.8	1	3
6.3 Volt @ 40°C (3.2 Volt @ 85°C, 1.3 Volt @ 125°C)								
TLCCK475M006#TA	0402	1005-07	K	4.7	6.3	0.5	15	3
TLCU475M006#TA	0805	2012-06	U	4.7	6.3	0.5	5	3
TLCJ106M006#TA	0603	1608-08	J	10	6.3	0.6	7.5	3
TLCCK106M006#TA	0402	1005-07	K	10	6.3	3.1	15	3
TLCZ106M006#TA	0602	1605-07	Z	10	6.3	0.6	15	3
TLCJ226M006#TA	0603	1608-10	L	22	6.3	1.4	7.5	3
TLCU226M006#TA	0805	2012-06	U	22	6.3	2.8	12	3
TLCJ336M006#TA	0805	2012-10	H	33	6.3	2.0	5	3
TLCJ336M006#TA	0603	1608-10	L	33	6.3	2.1	7.5	3
TLCJ336M006#4000	0603	1608-10	L	33	6.3	2.1	4	3
TLCU336M006#TA	0805	2012-06	U	33	6.3	10.4	7.5	3
TLCV336M006#TA	1206	3216-08	V	33	6.3	4.2	5	3
TLCJ476M006#TA	0805	2012-10	H	47	6.3	3.0	5	3
TLCV476M006#TA	1206	3216-08	V	47	6.3	6.0	15	3
TLCR686M006#TA	0805	2012-15	R	68	6.3	4.3	5	3
TLCR107M006#TA	0805	2012-15	R	100	6.3	6.0	5	3
TLCR157M006#TA	0805	2012-15	R	150	6.3	9.5	5	3

AVX Part No.	EIA Code	EIA Metric	Case Size	Cap (µF)	Rated Voltage (V)	DCL (µA) Max.	ESR Max. (Ω) @100kHz	MSL
8 Volt @ 40°C (4 Volt @ 85°C, 1.6 Volt @ 125°C)								
TLCCL336M008#TA	0603	1608-08	L	33	8	26.4	10	3
10 Volt @ 40°C (5 Volt @ 85°C, 2 Volt @ 125°C)								
TLCN474M010#TA	0402	1005-05	N	0.47	10	0.5	20	3
TLCJ225M010#TA	0603	1608-08	J	2.2	10	0.5	7.5	3
TLCCK225M010#TA	0402	1005-07	K	2.2	10	0.5	15	3
TLCJ475M010#TA	0603	1608-08	J	4.7	10	0.5	10	3
TLCCK475M010#TA	0402	1005-07	K	4.7	10	0.5	15	3
TLCU685M010#TA	0805	2012-06	U	6.8	10	0.7	5	3
TLCJ106M010#TA	0603	1608-08	J	10	10	1.0	7.5	3
TLCU106M010#TA	0805	2012-06	U	10	10	1.0	5	3
TLCZ106M010#TA	0602	1605-07	Z	10	10	1.0	15	3
TLCH156M010#TA	0805	2012-10	H	15	10	1.5	5	3
TLCJ156M010#TA	0603	1608-08	L	15	10	1.5	7.5	3
TLCCL226M010#TA	0603	1608-10	L	22	10	11	10	3
TLCM226M010#TA	0803	2008-10	M	22	10	2.2	7.5	3
TLCJ106M010#TA	0805	2012-10	H	33	10	3.3	5	3
TLCJ476M010#TA	1205	3216-10	C	47	10	4.7	2	3
TLCQ476M010#TA	0805	2012-12	Q	47	10	4.7	5	3
TLCR476M010#TA	0805	2012-15	R	47	10	4.7	5	3
TLCR686M010#TA	1206	3216-18	A	68	10	6.8	1	3
TLCR686M010#TA	0805	2012-15	R	68	10	6.8	5	3
TLCR107M010#TA	0805	2012-15	R	100	10	10	5	3
TLCR107M010#TA	1210	3528-12	T	100	10	10	1	3
16 Volt @ 40°C (8 Volt @ 85°C, 3.2 Volt @ 125°C)								
TLCJ334M016#TA	0603	1608-08	J	0.33	16	0.5	7.5	3
TLCCK474M016#TA	0402	1005-07	K	0.47	16	0.5	15	3
TLCJ105M016#TA	0603	1608-08	J	1.0	16	0.5	7.5	3
TLCCK105M016#TA	0402	1005-07	K	1	16	0.8	15	3
TLCJ225M016#TA	0603	1608-08	J	2.2	16	0.5	7.5	3
TLCCL335M016#TA	0603	1608-10	L	3.3	16	0.5	7.5	3
TLCV106M016#TA	1206	3216-08	V	10	16	1.6	2	3
20 Volt @ 40°C (10 Volt @ 85°C, 4 Volt @ 125°C)								
TLCJ105M020#TA	0603	1608-08	J	1.0	20	0.5	7.5	3
TLCJ225M020#TA	0805	2012-10	H	2.2	20	0.5	5	3
TLCJ225M020#TA	0603	1608-10	L	2.2	20	0.5	7.5	3
TLCR106M020#TA	0805	2012-15	R	10	20	2.0	5	3
25 Volt @ 40°C (12.5 Volt @ 85°C, 5 Volt @ 125°C)								
TLCCL334M025#TA	0603	1608-10	L	0.33	25	0.5	7.5	3
TLCCL105M025#TA	0603	1608-10	L	1.0	25	0.5	7.5	3
TLCJ225M025#TA	0805	2012-10	H	2.2	25	0.6	5	3
TLCR225M025#TA	0805	2012-15	R	2.2	25	0.6	5	3
TLCCT226M025#TA	1210	3528-12	T	22	25	5.5	1	3
35 Volt @ 40°C (17.5 Volt @ 85°C, 7 Volt @ 125°C)								
TLCCL105M035#TA	0603	1608-10	L	1.0	35	0.5	7.5	3
TLCR105M035#TA	0805	2012-15	R	1.0	35	0.5	5	3
TLCR475M035#TA	0805	2012-15	R	4.7	35	1.6	5	3
TLCAL106M035#TA	1206	3216-18	A	10	35	3.5	1	3

Voltage vs Temperature Rating

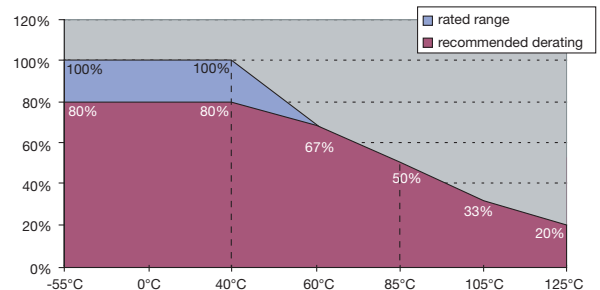

Moisture Sensitivity Level (MSL) is defined according to J-STD-020.

All technical data relates to an ambient temperature of +25°C. Capacitance and DF are measured at 120Hz, 0.5V RMS with a maximum DC bias of 2.2 volts. DCL is measured at rated voltage after 5 minutes.

DCL allowed to move up to 2.00 times the limit post mounting.

ESR allowed to move up to 1.25 times the limit post mounting.

For typical weight and composition see page 144.

NOTE: AVX reserves the right to supply a higher voltage rating or tighter tolerance part in the same case size, to the same reliability standards.



TLN Series



Tantalum Solid Electrolytic Chip Capacitors Undertab Series



- Undertab terminations layout:
 - High Volumetric Efficiency
 - High PCB assembly density
 - High capacitance in smaller dimensions
- 3x reflow 260°C compatible
- Consumer applications (e.g. PCMCIA/USB wireless express cards, mobiles, MP3 etc.)
- 7 case sizes available
- CV range: 47-1000µF / 4-10V

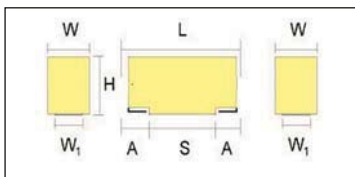

For part marking see page 151

CASE DIMENSIONS: millimeters (inches)

Code	EIA Code	EIA Metric	L±0.20 (0.008)	W+0.20 (0.008) -0.10 (0.004)	H max.	W1±0.20 (0.008)	A+0.30 (0.012) -0.20 (0.008)
G	1206	3216-15	3.20 (0.126)	1.60 (0.063)	1.50 (0.059)	1.20 (0.047)	0.80 (0.031)
K	1206	3216-10	3.20 (0.126)	1.60 (0.063)	1.00 (0.039)	1.20 (0.047)	0.80 (0.031)
L	1210	3528-10	3.50 (0.138)	2.80 (0.110)	1.00 (0.039)	2.20 (0.087)	0.80 (0.031)
M	0805	2012-09	2.05 (0.081)	1.30 (0.051)	0.90 (0.035)	1.00 (0.039)	0.80 (0.031)
N	0805	2012-10	2.05 (0.081)	1.30 (0.051)	1.00 (0.039)	1.00 (0.039)	0.50 (0.020)
S	1206	3216-12	3.20 (0.126)	1.60 (0.063)	1.20 (0.047)	1.20 (0.047)	0.80 (0.031)
T	1210	3528-12	3.50 (0.138)	2.80 (0.110)	1.20 (0.047)	2.20 (0.087)	0.80 (0.031)
Y	2917	7343-20	7.30 (0.287)	4.30 (0.169)	2.00 (0.079)	2.40 (0.094)	1.30 (0.051)

W1 dimension applies to the termination width for A dimensional area only.

Under development

HOW TO ORDER

TLN

Type

S

Case Size
See table above

227

Capacitance Code
pF code: 1st two digits represent significant figures, 3rd digit represents multiplier (number of zeros to follow)

M

Tolerance
M = ±20%

004

Rated DC Voltage
004 = 4Vdc
006 = 6.3Vdc
010 = 10Vdc

R

Packaging
R = Pure Tin 7" Reel
S = Pure Tin 13" Reel

3000

ESR in mΩ

TECHNICAL SPECIFICATIONS

Technical Data:	All technical data relate to an ambient temperature of +25°C				
Capacitance Range:	47 µF to 1000 µF				
Capacitance Tolerance:	±20%				
Rated Voltage (V _R)	-55°C ≤ +40°C:	4	6.3	10	
Category Voltage (V _C)	at 85°C:	2	3.15	5	
Category Voltage (V _C)	at 125°C:	0.8	1.26	2	
Temperature Range:	-55°C to +125°C with category voltage				
Reliability:	0.2% per 1000 hours at 85°C, 0.5xV _R with 0.1Ω/V series impedance with 60% confidence level				

TLN Series



Tantalum Solid Electrolytic Chip Capacitors Undertab Series

CAPACITANCE AND RATED VOLTAGE, VR (VOLTAGE CODE) RANGE (LETTER DENOTES CASE SIZE)

Capacitance		Rated Voltage DC to 40°C / 0.5DC to 85°C/ 0.2DC to 125°C		
µF	Code	4V (G)	6.3V (J)	10V (A)
33	336			
47	476			K(1500)/M(6000)/N(6000)
68	686	N(3000)*	K(5400)	K(5400)/S(6000)
100	107	N(5200)	K(2000,5400)/S(5400)	K(2500)/L(7200)* S(2500)
150	157	K(2500)/S(2500)	K(2500)/L(5400)* S(2500)	H(6000)/(1300)/ S(7200)*T(1500)
220	227	K(2500)/L(1300) S(3000)/T(1500)	L(1000) S(8300)*T(1500)	G(7200)*H(6000)* T(1300)
330	337	G(4000)*L(4000)* S(5200)*	G(5400)*H(3000)*	H(7200)*T(9600)*
470	477	G(5200)*H(3000)* T(4000)*	H(5400)*T(8300)*	H(9600)*
680	687	H(4000)*T(5200)*	H(8300)*	
1000	108	H(5200)*	Y(150)	

Available Ratings, (ESR ratings in mOhms in brackets)

Engineering samples - please contact manufacturer

*Codes under development - subject to change

Note: Voltage ratings are minimum values. AVX reserves the right to supply higher ratings in the same case size, to the same reliability standards.

RATINGS & PART NUMBER REFERENCE

AVX Part No.	Case Size	Capacitance (µF)	Rated Voltage (V)	Maximum Surge Current (A)*	DCL (µA) Max.	ESR Max. (mΩ) @100kHz	MSL	100kHz Ripple Current (mA)			100kHz Ripple Voltage (mV)		
								25°C	85°C	125°C	25°C	85°C	125°C
4 Volt @ 40°C (2 Volt @ 85°C, 0.8 Volt @ 125°C)													
TLNN107M004#5200	N	100	4	0.4	20	5200	3	88	79	35	456	410	182
TLNK157M004#2500	K	150	4	0.7	12	2500	3	148	133	59	371	334	148
TLNS157M004#2500	S	150	4	0.7	12	2500	3	148	133	59	371	334	148
TLNK227M004#2500	K	220	4	0.7	44	2500	3	148	133	59	371	334	148
TLNL227M004#1300	L	220	4	1.1	17.6	1300	3	215	193	86	279	251	112
TLNS227M004#3000	S	220	4	0.6	17.6	3000	3	135	122	54	406	366	162
TLNT227M004#1500	T	220	4	1.0	17.6	1500	3	216	194	86	324	292	130
6.3 Volt @ 40°C (3.15 Volt @ 85°C, 1.26 Volt @ 125°C)													
TLNK686M006#5400	K	68	6.3	0.5	4.1	5400	3	101	91	40	545	490	218
TLNK107M006#2000	K	100	6.3	1.3	12	2000	3	166	149	66	332	298	133
TLNK107M006#5400	K	100	6.3	0.5	6	5400	3	101	91	40	545	490	218
TLNS107M006#5400	S	100	6.3	0.5	6	5400	3	101	91	40	545	490	218
TLNK157M006#2500	K	150	6.3	1.1	18	2500	3	148	133	59	371	334	148
TLNS157M006#2500	S	150	6.3	1.1	18	2500	3	148	133	59	371	334	148
TLNL227M006#1000	L	220	6.3	2.2	26.4	1000	3	245	220	98	245	220	98
TLNT227M006#1500	T	220	6.3	1.6	26.4	1500	3	216	194	86	324	292	130
TLNY108M006#0150	Y	1000	6.3	5.3	63	150	3	876	788	350	131	118	53
10 Volt @ 40°C (5 Volt @ 85°C, 2 Volt @ 125°C)													
TLNK476M010#1500	K	47	10	2.6	4.7	1500	3	191	172	77	287	259	115
TLNM476M010#6000	M	47	10	0.8	9.4	6000	3	82	73	33	490	441	196
TLNN476M010#6000	N	47	10	0.8	9.4	6000	3	82	73	33	490	441	196
TLNK686M010#5400	K	68	10	0.9	6.8	5400	3	101	91	40	545	490	218
TLNS686M010#6000	S	68	10	0.8	6.8	6000	3	96	86	38	574	517	230
TLNK107M010#2500	K	100	10	1.7	20	2500	3	148	133	59	371	334	148
TLNS107M010#2500	S	100	10	1.7	20	2500	3	148	133	59	371	334	148
TLNH157M010#6000	H	150	10	0.8	30	6000	3	108	97	43	648	583	259
TLNL157M010#1300	L	150	10	2.9	30	1300	3	215	193	86	279	251	112
TLNT157M010#1500	T	150	10	2.6	30	1500	3	216	194	86	324	292	130
TLNT227M010#1300	T	220	10	2.9	44	1300	3	232	209	93	302	271	121

Moisture Sensitivity Level (MSL) is defined according to J-STD-020.

All technical data relates to an ambient temperature of +25°C. Capacitance and DF are measured at 120Hz, 0.5V RMS with a maximum DC bias of 2.2 volts. DCL is measured at rated voltage after 5 minutes.

ESR allowed to move up to 1.25 times catalogue limit post mounting

DCL allowed to move up to 2.00 times catalogue limit post mounting

For typical weight and composition see page 144.

NOTE: AVX reserves the right to supply a higher voltage rating or tighter tolerance part in the same case size, to the same reliability standards.

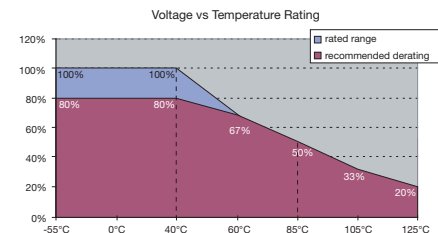

TLN PulseCap™ Series



Tantalum Solid Electrolytic Chip Capacitors Undertab Series



- Large case size for maximum capacitance
- 3x reflow 260°C compatible
- Low profile solution
- Consumer applications (e.g. PCMCIA/USB wireless express cards etc.)
- CV range: 1000-3300µF / 4-10V
- 2 case sizes available



LEAD-FREE
LEAD-FREE COMPATIBLE
COMPONENT



RoHS
COMPLIANT

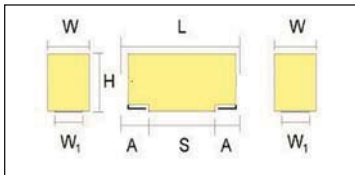

For part marking see page 151

CASE DIMENSIONS: millimeters (inches)

Code	EIA Code	EIA Metric	L+0.50 (0.020) -0.00 (0.000)	W+0.20 (0.008) -0.10 (0.004)	H max.	W ₁ ±0.20 (0.008)	A+0.30 (0.012) -0.20 (0.008)
4	2924	7361-20	7.30 (0.287)	6.10 (0.240)	2.00 (0.079)	4.75 (0.187)	2.00 (0.079)
6	6030	15075-20	14.50 (0.571)	7.50 ^{+0.50} -0.00 (0.295 ^{+0.020} -0.000)	2.00 (0.079)	5.50 (0.217)	2.40 (0.094)

W1 dimension applies to the termination width for A dimensional area only.

HOW TO ORDER

TLN

Type

6

Case Size
See table
above

228

Capacitance Code
pF code: 1st two digits
represent significant figures,
3rd digit represents multiplier

M

Tolerance
M = ±20%

006

Rated DC Voltage
004 = 4Vdc
006 = 6.3Vdc
010 = 10Vdc

R

Packaging
R = Pure Tin 7" Reel

0055

ESR in mΩ

TECHNICAL SPECIFICATIONS

Technical Data:	All technical data relate to an ambient temperature of +25°C				
Capacitance Range:	1000 µF to 3300 µF				
Capacitance Tolerance:	±20%				
Leakage Current DCL:	0.01CV				
Rated Voltage (V _R)	-55°C ≤ +40°C:	4	6.3	10	
Category Voltage (V _C)	at 85°C:	2	3.15	5	
Category Voltage (V _C)	at 125°C:	0.8	1.26	2	
Temperature Range:	-55°C to +125°C with category voltage				
Reliability:	0.2% per 1000 hours at 85°C, 0.5xV _R with 0.1Ω/V series impedance with 60% confidence level				

TLN PulseCap™ Series



Tantalum Solid Electrolytic Chip Capacitors Undertab Series

CAPACITANCE AND RATED VOLTAGE, VR (VOLTAGE CODE) RANGE (FIGURE DENOTES CASE SIZE)

Capacitance		Voltage Rating DC (V _R) to 85°C		
µF	Code	4V (G)	6.3V (J)	10V (A)
680	687			
1000	108			4(100)/6(55)
1500	158		4(100)	6(55)
2200	228		6(55)	
3300	338	6(55)	6*	

Available Codes (ESR ratings in mOhms in brackets)

Engineering samples - please contact manufacturer

*Codes under development - subject to change

Note: Voltage ratings are minimum values. AVX reserves the right to supply higher ratings in the same case size, to the same reliability standards.

RATINGS & PART NUMBER REFERENCE

AVX Part No.	Case Size	Cap (µF)	Rated Voltage (V)	DCL (µA) Max.	ESR Max. (mΩ) @100kHz	MSL	100kHz Ripple Current (mA)			100kHz Ripple Voltage (mV)			
							25°C	85°C	125°C	25°C	85°C	125°C	
4 Volt @ 40°C (2 Volt @ 85°C, 0.8 Volt @ 125°C)													
TLN6338M004#0055	6	3300	4	132	55	3	2045	1840	818	112	101	45	
6.3 Volt @ 40°C (3.15 Volt @ 85°C, 1.26 Volt @ 125°C)													
TLN4158M006#0100	4	1500	6.3	90	100	3	1285	1156	514	128	116	51	
TLN6228M006#0055	6	2200	6.3	132	55	3	2045	1840	818	112	101	45	
10 Volt @ 40°C (5 Volt @ 85°C, 2 Volt @ 125°C)													
TLN4108M010#0100	4	1000	10	100	100	3	1285	1156	514	128	116	51	
TLN6108M010#0055	6	1000	10	100	55	3	2045	1840	818	112	101	45	
TLN6158M010#0055	6	1500	10	150	55	3	2045	1840	818	112	101	45	

Moisture Sensitivity Level (MSL) is defined according to J-STD-020.

All technical data relates to an ambient temperature of +25°C. Capacitance and DF are measured at 120Hz, 0.5V RMS with a maximum DC bias of 2.2 volts. DCL is measured at rated voltage after 5 minutes.

ESR allowed to move up to 1.25 times catalogue limit post mounting

DCL allowed to move up to 2.00 times catalogue limit post mounting

For typical weight and composition see page 144.

NOTE: AVX reserves the right to supply a higher voltage rating or tighter tolerance part in the same case size, to the same reliability standards.

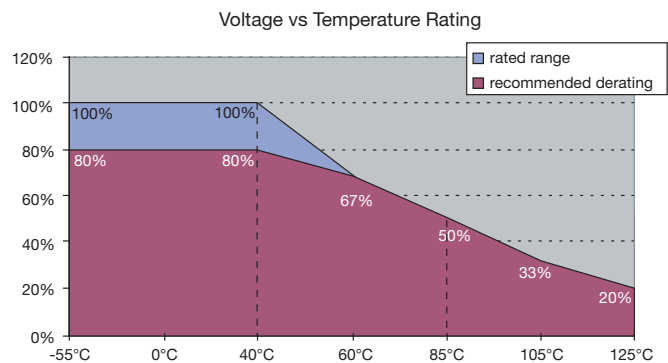

F98 Series



Resin-Molded Chip, High CV Frameless®

FRAMELESS™

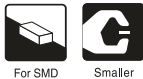

Upgrade

- Compliant to the RoHS directive (2002/95/EC).

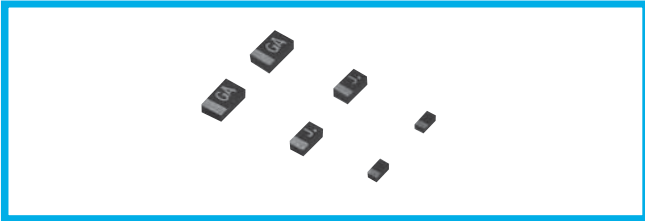

Applications

- Smartphone
- Wireless module
- Mobile phone
- Hearing aid

Type numbering system (Example : 6.3V 10µF)

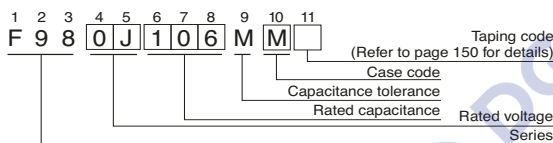

Drawing

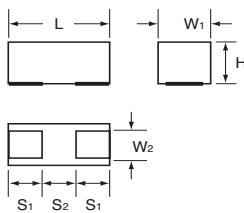

Case Code	L	W ₁	W ₂	H	S ₁	S ₂
U	1.10 ± 0.05	0.60 ± 0.05	0.35 ± 0.05	0.55 ± 0.05	0.3 ± 0.05	0.5 ± 0.05
M	1.6 ^{+0.2} _{-0.1}	0.85 ^{+0.2} _{-0.1}	0.65 ± 0.1	0.8 ± 0.1	0.5 ± 0.1	0.6 ± 0.1
S	2.0 ^{+0.2} _{-0.1}	1.25 ^{+0.2} _{-0.1}	0.9 ± 0.1	0.8 ± 0.1	0.5 ± 0.1	1.0 ± 0.1

Marking

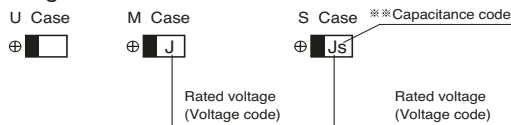

Standard Ratings

Cap. (µF)	Code	V						Capacitance code
		4	6.3	10	16	20	25	
1	105				M	M	M	—
2.2	225			U · M	M			—
4.7	475	U	U · M	(U) · M	M			—
10	106	U	(U) · M	M	S			a
22	226	M	M	(M) · S				J
33	336	M	M	(M) · S				n
47	476	M	M · S	S				s
68	686	M · S						w
100	107	M · S	S					A
220	227	S						J

() The series in parentheses are being developed. Please contact to your local AVX sales office when these series are being designed in your application.

We can consider the type of compliance to AEC-Q200. Please contact to your local AVX sales office when these series are being designed in your application.

Specifications

Item	Performance Characteristics
Category	—55 to +125°C (Rated temperature : +85°C)
Temperature Range	
Capacitance Tolerance	±20% (at 120Hz)
Dissipation Factor	Refer to the table below
ESR	Refer to the table below
Leakage Current	Refer to the table below Provided that • After 5 minute's application of rated voltage, leakage current at 85°C, 10 times or less than 20°C specified value. • After 5 minute's application of rated voltage, leakage current at 125°C, 12.5 times or less than 20°C specified value.
Damp Heat (Steady State)	At 40°C, 90 to 95% R.H., For 500hours (No voltage applied) Capacitance Change . . . Refer to the table below (* 1) Dissipation Factor 150% or less of initial specified value Leakage Current 200% or less of initial specified value
Temperature Cycles	At -55°C / +125°C, For 30 minutes each, 5 cycles Capacitance Change . . . Refer to the table below (* 1) Dissipation Factor 150% or less than the initial specified value Leakage Current Initial specified value or less
Resistance to Soldering Heat	10 seconds reflow at 260°C, 5 seconds immersion at 260°C Capacitance Change . . . Refer to the table below (* 1) Leakage Current Initial specified value or less Leakage Current Initial specified value or less
Surge	After application of surge in series with a 1kΩ resistor at the rate of 30 seconds ON, 30 seconds OFF, for 1000 successive test cycles at 85°C, capacitors shall meet the characteristic requirements listed below. Capacitance Change . . . Refer to the table below (* 1) Dissipation Factor 150% or less than the initial specified value Leakage Current 200% or less than the initial specified value
Endurance	After 1000 hours' application of rated voltage in series with a 3Ω resistor at 85°C, capacitors shall meet the characteristic requirements table below Capacitance Change . . . Refer to the table below (* 1) Dissipation Factor 150% or less than the initial specified value Leakage Current 200% or less than the initial specified value
Shear Test	After applying the pressure load of 5N for 10±1 seconds horizontally to the center of capacitor side body which has no electrode and has been soldered beforehand on a substrate, there shall be found neither exfoliation nor its sign at the terminal electrode. For 10 ± 1 seconds
Terminal Strength	Keeping a capacitor surface-mounted on a substrate upside down and supporting the substrate at both of the opposite bottom points 45mm apart from the center of capacitor, the pressure strength is applied with a specified jig at the center of the substrate so that substrate may bend by 1mm as illustrated. Then, there shall be found no remarkable abnormality on the capacitor terminals.

Rated Volt	Rated Capacitance (µF)	Case code	Part Number	*2 Leakage Current (µA)	Dissipation Factor (% @ 120kHz)	ESR (Ω @ 100kHz)	*1 Δ/C (%)
4V	4.7	U	F980G475MUA	0.5	20	20	±30
	10	U	F980G106MUA	0.8	25	20	±30
	22	M	F980G226MMA	0.9	15	7.5	±30
	33	M	F980G336MMA	1.3	30	4	±30
	47	M	F980G476MMA	1.9	40	8	±30
	68	M	F980G686MMA	27.2	50	10	±30
	68	S	F980G686MSA	2.7	30	4	±30
	100	M	F980G107MMA	80.0	60	10	±30
	100	S	F980G107MSA	4.0	35	4	±30
	220	S	F980G227MSA	132	80	5	±30
6.3V	4.7	U	F980J475MUA	0.6	20	20	±30
	4.7	M	F980J475MMA	0.5	20	7.5	±30
	10	M	F980J106MMA	0.6	8	6	±30
	22	M	F980J226MMA	1.4	20	6	±30
	33	M	F980J336MMA	4.2	35	8	±30
	47	M	F980J476MMA	29.6	45	10	±30
	47	S	F980J476MSA	3.0	25	6	±30
100	S	F980J107MSA	63.0	50	8	±30	
10V	2.2	U	F981A225MUA	0.5	15	15	±30
	2.2	M	F981A225MMA	0.5	6	7.5	±30
	4.7	M	F981A475MMA	0.5	6	6	±30
	10	M	F981A106MMA	1.0	20	7.5	±30
	22	S	F981A226MSA	2.2	20	4	±20
	33	S	F981A336MSA	3.3	30	6	±30
	47	S	F981A476MSA	9.4	35	5	±30
16V	1	M	F981C105MMA	0.5	6	10	±30
	2.2	M	F981C225MMA	0.5	6	10	±30
	4.7	M	F981C475MMA	0.8	12	12	±30
	10	S	F981C106MSA	1.6	18	4	±20
20V	1	M	F981D105MMA	0.5	6	10	±30
25V	1	M	F981E105MMA	0.5	8	10	±30

*2 : Leakage Current
After 5 minute's application of rated voltage, leakage current at 20°C.



F72/F75 Series



Low Profile and HiCV Conformal Coated Chip

FRAMELESS™



Upgrade

● Compliant to the RoHS directive (2002/95/EC).



Applications

- Wireless modem
- Tablet PC
- e-book
- SSD
- Smart meter

F72

■ Type numbering system (Example: 10V 100μF)

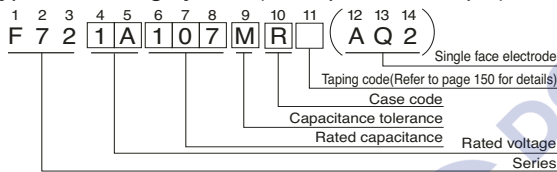

Drawing

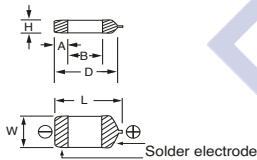

Dimensions

Case code	L	W	H	A	B	(D)
R	7.2 ± 0.3	6.0 ± 0.3	1.2 ± 0.3	1.3 ± 0.4	3.8 ± 0.6	(6.2)
M	7.2 ± 0.3	6.0 ± 0.3	2.0MAX.	1.3 ± 0.4	3.8 ± 0.6	(6.2)

D dimension only for reference

F75

■ Type numbering system (Example: 16V 150μF)

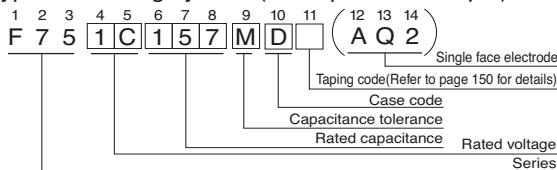

Drawing

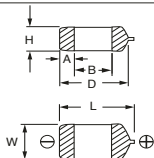

Standard Ratings

F72

Cap. (μF)	Code	V			
		4	6.3	10	16
33	336				R
47	476			R	R
68	686		R	R	R
100	107	R	R	R	
150	157	R	R	R	
220	227	R	R	R	
330	337	R	R	(R)	
470	477			M	
680	687			M	
1000	108		M	M	
1500	158		M		

() The series in parentheses are being developed. Please contact to your local AVX sales office when these series are being designed in your application.

Specifications

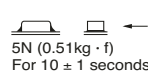
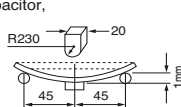
Item	Performance Characteristics
Category	
Temperature Range	-55 to +125°C (Rated temperature : +85°C)
Capacitance Tolerance	±20%, ±10% (at 120Hz)
Dissipation Factor (120Hz)	Refer to next page
ESR (100kHz)	Refer to next page
Leakage Current	<ul style="list-style-type: none"> • After 1 minute's application of rated voltage, leakage current at 20°C is not more than 0.01CV or 0.5μA, whichever is greater. • After 1 minute's application of rated voltage, leakage current at 85°C is not more than 0.1CV or 5μA, whichever is greater. • After 1 minute's application of derated voltage, leakage current at 125°C is not more than 0.125CV or 6.3μA, whichever is greater.
Capacitance Change by Temperature	+15% Max. (at +125°C) +10% Max. (at +85°C) -10% Max. (at -55°C)
Damp Heat (Steady State)	At 40°C, 90 to 95% R.H., For 500 hours (No voltage applied) Capacitance Change Refer to * 1 Dissipation Factor Initial specified value or less Leakage Current Initial specified value or less
Temperature Cycles	At -55°C / +125°C, 30 minutes each, For 5 cycles, Capacitance Change Refer to * 1 Dissipation Factor Initial specified value or less Leakage Current Initial specified value or less
Resistance to Soldering Heat	10 seconds reflow at 260°C, 10 seconds immersion at 260°C Capacitance Change Refer to * 1 Dissipation Factor Initial specified value or less Leakage Current Initial specified value or less
Surge	After application of surge in series with a 33Ω resistor at the rate of 30 seconds ON, 30 seconds OFF, for 1000 successive test cycles at 85°C, capacitors shall meet the characteristic requirements table below. Capacitance Change Refer to * 1 Dissipation Factor Initial specified value or less Leakage Current Initial specified value or less
Endurance	After 2000 hours' application of rated voltage at 85°C, capacitors shall meet the characteristic requirements table below. Capacitance Change Refer to * 1 Dissipation Factor Initial specified value or less Leakage Current Initial specified value or less
Shear Test	After applying the pressure load of 5N for 10±1 seconds horizontally to the center of capacitor side body which has no electrode and has been soldered beforehand on a substrate, there shall be found neither exfoliation nor its sign at the terminal electrode. 
Terminal Strength	Keeping a capacitor surface-mounted on a substrate upside down and supporting the substrate at both of the opposite bottom points 45mm apart from the center of capacitor, the pressure strength is applied with a specified jig at the center of substrate so that the substrate may bend by 1mm as illustrated. Then, there shall be found no remarkable abnormality on the capacitor terminals. 

Dimensions

Case code	L	W	H	A	B	(D)
U	7.1 ± 0.3	3.2 ± 0.3	2.0MAX.	1.3 ± 0.3	3.6 ± 0.6	(6.0)
C	7.1 ± 0.3	3.2 ± 0.3	2.5 ± 0.3	1.3 ± 0.3	3.6 ± 0.6	(6.0)
D	7.3 ± 0.3	4.3 ± 0.3	2.8 ± 0.3	1.3 ± 0.4	3.9 ± 0.6	(6.4)
R	7.2 ± 0.3	6.0 ± 0.3	3.5 ± 0.3	1.3 ± 0.4	3.8 ± 0.6	(6.2)

D dimension only for reference

F75

Cap. (μF)	Code	V			
		4	6.3	10	16
68	686				C
100	107				C
150	157				D
220	227		C	C · D	R
330	337	C	C · D	D	
470	477	C · D	U · D	U · R	
680	687	D	(U) · D · R		
1000	108	D · R	(U) · R		
1500	158	R			
2200	228	R			



F72/F75 Series



Low Profile and HiCV Conformal Coated Chip

F72

Standard Ratings

Rated Volt	Rated Capacitance (μF)	Case code	Part Number	Leakage Current (μA)	Dissipation Factor (%@120Hz)	ESR (Ω@100kHz)	*1 ΔC/C (%)
4V	100	R	F720G107MRC	4.0	8	0.70	*
	150	R	F720G157MRC	6.0	10	0.70	*
	220	R	F720G227MRC	8.8	12	0.70	*
	330	R	F720G337MRC	13.2	12	0.70	*
6.3V	68	R	F720J686MRC	4.3	6	0.75	*
	100	R	F720J107MRC	6.3	8	0.70	*
	150	R	F720J157MRC	9.5	10	0.70	*
	220	R	F720J227MRC	13.9	12	0.70	*
	330	R	F720J337MRC	20.8	12	0.70	*
	1000	M	F720J108MMC	63.0	30	0.14	±15
1500	M	F720J158MMC	95.0	45	0.14	±20	
10V	47	R	F721A476MRC	4.7	6	0.80	*
	68	R	F721A686MRC	6.8	6	0.75	*
	100	R	F721A107MRC	10.0	8	0.70	*
	150	R	F721A157MRC	15.0	10	0.70	*
	220	R	F721A227MRC	22.0	12	0.70	*
	470	M	F721A477MMC	47.0	30	0.14	±15
	680	M	F721A687MMC	68.0	35	0.14	±20
	1000	M	F721A108MMC	200	45	0.14	±20
16V	33	R	F721C336MRC	5.3	6	0.90	*
	47	R	F721C476MRC	7.5	6	0.80	*
	68	R	F721C686MRC	10.9	6	0.75	*

*1 : ΔC/C Marked "**"

	F72 ALL Case (%)
Damp Heat	±10
Temperature cycles	±5
Resistance soldering heat	±5
Surge	±5
Endurance	±10

F75

Standard Ratings

Rated Volt	Rated Capacitance (μF)	Case code	Part Number	Leakage Current (μA)	Dissipation Factor (%@120Hz)	ESR (Ω@100kHz)	*1 ΔC/C (%)
4V	330	C	F750G337MCC	13.2	10	0.15	*
	470	C	F750G477MCC	18.8	14	0.12	*
	470	D	F750G477MDC	18.8	14	0.12	*
	680	D	F750G687MDC	27.2	18	0.12	*
	1000	D	F750G108MDC	40.0	24	0.12	*
	1000	R	F750G108MRC	40.0	24	0.12	*
	1500	R	F750G158MRC	60.0	30	0.12	*
	2200	R	F750G228MRC	88.0	45	0.07	*
6.3V	220	C	F750J227MCC	13.9	10	0.20	*
	330	C	F750J337MCC	20.8	10	0.15	*
	330	D	F750J337MDC	20.8	10	0.15	*
	470	U	F750J477MUC	29.6	15	0.10	*
	470	D	F750J477MDC	29.6	14	0.12	*
	680	D	F750J687MDC	42.8	18	0.12	*
	680	R	F750J687MRC	42.8	18	0.12	*
	1000	R	F750J108MRC	63.0	24	0.12	*
10V	150	C	F751A157MCC	15.0	10	0.22	*
	220	C	F751A227MCC	22.0	10	0.20	*
	220	D	F751A227MDC	22.0	10	0.20	*
	330	D	F751A337MDC	33.0	10	0.15	*
	470	U	F751A477MUC	94.0	30	0.15	±20
	470	R	F751A477MRC	47.0	14	0.12	*
16V	68	C	F751C686MCC	10.9	10	0.22	*
	100	C	F751C107MCC	16.0	10	0.22	*
	150	D	F751C157MDC	24.0	10	0.22	*
	220	R	F751C227MRC	35.2	10	0.20	*

*1 : ΔC/C Marked "**"

	F75 ALL Case (%)
Damp Heat	±10
Temperature cycles	±5
Resistance soldering heat	±5
Surge	±5
Endurance	±10



TPS Series



Low ESR



- Low ESR series of robust MnO₂ solid electrolyte capacitors
- CV range: 0.15-1500µF / 2.5-50V
- 14 case sizes available
- Power supply applications



LEAD-FREE
LEAD-FREE COMPATIBLE
COMPONENT



SnPb termination option is not
RoHS compliant.

CASE DIMENSIONS: millimeters (inches)

Code	EIA Code	EIA Metric	L±0.20 (0.008)	W±0.20 (0.008) -0.10 (0.004)	H±0.20 (0.008) -0.10 (0.004)	W ₂ ±0.20 (0.008)	A±0.30 (0.012) -0.20 (0.008)	S Min.
A	1206	3216-18	3.20 (0.126)	1.60 (0.063)	1.60 (0.063)	1.20 (0.047)	0.80 (0.031)	1.10 (0.043)
B	1210	3528-21	3.50 (0.138)	2.80 (0.110)	1.90 (0.075)	2.20 (0.087)	0.80 (0.031)	1.40 (0.055)
C	2312	6032-28	6.00 (0.236)	3.20 (0.126)	2.60 (0.102)	2.20 (0.087)	1.30 (0.051)	2.90 (0.114)
D	2917	7343-31	7.30 (0.287)	4.30 (0.169)	2.90 (0.114)	2.40 (0.094)	1.30 (0.051)	4.40 (0.173)
E	2917	7343-43	7.30 (0.287)	4.30 (0.169)	4.10 (0.162)	2.40 (0.094)	1.30 (0.051)	4.40 (0.173)
F	2312	6032-20	6.00 (0.236)	3.20 (0.126)	2.00 (0.079) max.	2.20 (0.087)	1.30 (0.051)	2.90 (0.114)
P	0805	2012-15	2.05 (0.081)	1.35 (0.053)	1.50 (0.059) max.	1.00±0.10 (0.039±0.004)	0.50 (0.020)	0.85 (0.033)
R	0805	2012-12	2.05 (0.081)	1.30 (0.051)	1.20 (0.047) max.	1.00±0.10 (0.039±0.004)	0.50 (0.020)	0.85 (0.033)
S	1206	3216-12	3.20 (0.126)	1.60 (0.063)	1.20 (0.047) max.	1.20 (0.047)	0.80 (0.031)	1.10 (0.043)
T	1210	3528-12	3.50 (0.138)	2.80 (0.110)	1.20 (0.047) max.	2.20 (0.087)	0.80 (0.031)	1.40 (0.055)
V	2924	7361-38	7.30 (0.287)	6.10 (0.240)	3.55 (0.140)	3.10 (0.120)	1.30 (0.051)	4.40 (0.173)
W	2312	6032-15	6.00 (0.236)	3.20 (0.126)	1.50 (0.059) max.	2.20 (0.087)	1.30 (0.051)	2.90 (0.114)
X	2917	7343-15	7.30 (0.287)	4.30 (0.169)	1.50 (0.059) max.	2.40 (0.094)	1.30 (0.051)	4.40 (0.173)
Y	2917	7343-20	7.30 (0.287)	4.30 (0.169)	2.00 (0.079) max.	2.40 (0.094)	1.30 (0.051)	4.40 (0.173)

W1 dimension applies to the termination width for A dimensional area only.

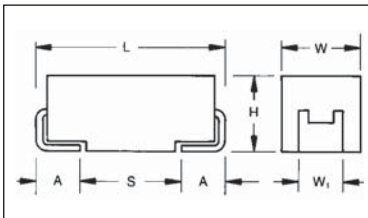

For part marking see page 151

HOW TO ORDER

TPS	C	107	M	010	R	0100	-
Type	Case Size See table above	Capacitance Code pF code: 1st two digits represent significant figures, 3rd digit represents multiplier (number of zeros to follow)	Tolerance K = ±10% M = ±20%	Rated DC Voltage 002 = 2.5Vdc 004 = 4Vdc 006 = 6.3Vdc 010 = 10Vdc 016 = 16Vdc 020 = 20Vdc 025 = 25Vdc 035 = 35Vdc 050 = 50Vdc	Packaging R = Pure Tin 7" Reel S = Pure Tin 13" Reel A = Gold Plating 7" Reel B = Gold Plating 13" Reel H = Tin Lead 7" Reel (Contact Manufacturer) K = Tin Lead 13" Reel (Contact Manufacturer) H, K = Non RoHS	ESR in mΩ	Additional characters may be added for special requirements V = Dry pack Option (selected codes only)

TECHNICAL SPECIFICATIONS

Technical Data:	All technical data relate to an ambient temperature of +25°C									
Capacitance Range:	0.15 µF to 1500 µF									
Capacitance Tolerance:	±10%; ±20%									
Rated Voltage (V _R)	≤ +85°C:	2.5	4	6.3	10	16	20	25	35	50
Category Voltage (V _C)	≤ +125°C:	1.7	2.7	4	7	10	13	17	23	33
Surge Voltage (V _S)	≤ +85°C:	3.3	5.2	8	13	20	26	32	46	65
Surge Voltage (V _S)	≤ +125°C:	2.2	3.4	5	8	13	16	20	28	40
Temperature Range:	-55°C to +125°C									
Environmental Classification:	55/125/56 (IEC 68-2)									
Reliability:	1% per 1000 hours at 85°C, V _R with 0.1Ω/V series impedance, 60% confidence level									
Termination Finished:	Sn Plating (standard), Gold and SnPb Plating upon request									
	For AEC-Q200 availability, please contact AVX									



CAPACITANCE AND RATED VOLTAGE, VR (VOLTAGE CODE) RANGE (LETTER DENOTES CASE SIZE)

Capacitance		Rated Voltage DC (V _R) to 85°C								
µF	Code	2.5V (e)	4V (G)	6.3V (J)	10V (A)	16V (C)	20V (D)	25V (E)	35V (V)	50V (T)
0.15	154									A(9000)
0.22	224								A(6000)	A(7000)
0.33	334								A(6000)	A(7000)
0.47	474							A(7000)	A(6000), B(4000)	A(6500), B(6000), C(2300)
0.68	684							A(6000)	A(6000)	B(4000)
1.0	105				R(9000)	A(6200)	A(3000), R(6000), S(6000), T(2000)	A(4000), R(2500,4000)	A(3000), B(2000)	B(3000), C(2500)
1.5	155						A(3000)	A(3000), B(1800)	A(3000), B(2500)	C(1500,2000)
2.2	225			R(7000)	A(1800)	A(1800,3500), T(2000)	A(3000), B(1700)	A(2500), B(900,1200,2500)	A(1500), B(750,1500,2000), C(1000)	C(1500), D(1200)
3.3	335			A(2100)	T(1500)	A(3500), B(2500)	A(2500), B(1300)	A(1000,1500), B(750,1500,2000)	B(1000), C(700)	C(1000), D(800)
4.7	475			S(4000)	A(1400), B(1400), R(3000,5000)	A(2000), B(800,1500)	A(1800), B(750,1000)	B(700,900,1500), C(700)	B(700,1500), C(600), D(700)	C(800), D(300,500,700)
6.8	685			A(1800)	A(1800), B(1300), T(1800)	A(1500), B(600,1200)	A(1000), B(600,1000), C(700)	B(700), C(500,600,700)	C(350), D(150,400,500)	D(200, 300, 500,600)
10	106		R(3000)	A(1500), B(1500), R(1000,1500,3000), T(1000)	A(900,1800), B(1000), P(2000)*, S(900), T(1000,2000)	A(1000), B(500,800), C(500), T(800,1000), W(500,600)	B(500,1000), C(500,700), W(250, 500)	B(1800), C(300,500), D(500)	C(600), D(125,300), E(200), Y(250)	D(500), E(250,300, 400,500)
15	156			A(700,1500)	A(1000), B(450,600), C(700), T(1200)	B(500,800), C(700)	B(500), C(400,450)	C(220,300), D(100,300)	C(350, 450), D(100,300), Y(250)	E(250), V(250)
22	226			A(500,900), B(375,600), C(500), S(900)	A(900), B(400,500,700), C(300), T(800)	B(400,600), C(150,250,300,375), D(700), W(500)	B(400,600), C(100,150,400), D(200,300)	C(275,400), D(100,200,300)	D(125,200,300,400), E(125,200,300), Y(200)	
33	336			A(600), B(250,350,450,600), T(800)	A(700), B(250,425,500,650), C(150,375,500), W(350)	B(350,500), C(100,150,225,300), D(200), W(140,175, 250,400,500), Y(300,400)	C(300), D(100,200)	D(100,200,300), E(100,175, 200,300), Y(200)	D(200,300), E(100,250,300), V(200)	
47	476		A(500)	A(800), B(250,350,500), C(300), T(1200)	B(250,350,500,650), C(200,350), D(100,300), W(125,150,250)	C(110,350), D(80,100,150,200), W(200), X(180), Y(250)	D(75,100,200), E(70,125,150, 200,250), X(200)	D(125,150,250), E(80,100,125), Y(250)	E(200,250), V(150,200)	
68	686			B(250,350,500), C(150,200), W(110,125,250)	B(600), C(80,100,200,300), D(100,150), W(100,150), Y(100,200)	C(125,200), D(70,100,150), F(200), X(150), Y(150,200,250)	D(70,150, 200,300), F(200), X(150), Y(150,200,250), Y(200)	E(125,200), V(80,95,150,200)	V(150,200)	
100	107	B(200)	B(200,250, 350,500), W(100)	B(250,400), C(75,150), D(300), W(100,150), Y(100)	B(400) ^M , C(75,100,150,200), D(50,65,80,100,125, 150), E(125), W(150), X(85,150,200), Y(100,150,200)	C(200), D(60,100,125,150), E(55,100,125,150), F(150,200) ^M , Y(100,150,200)	D(85,100,150), E(100,150,200), V(60,85,100,200)	E(150) ^M , V(100)		
150	157	B(150)	B(250), C(70,80)	C(50,90,150,200,250), D(50,125), Y(40,50)	C(150), D(50,85,100), E(100), F(200), X(100) ^M , Y(100,150,200)	D(60,85,100,125,150), E(100), V(45,75), Y(200) ^M	V(80)	V(150) ^M		
220	227	B(150, 200,600), D(45)	D(40,50,100), Y(40,50,75)	C(70,100,125,250), D(50,100,125), E(100), F(200), Y(100,150)	D(40,50,100,150), E(50,60,70,100, 125,150), Y(100,150,200)	E(100,150), V(50,75,100,150)				
330	337	Y(40)	C(100), D(35,45,100), F(200), X(100)	C(80,100), D(45,50,70,100), E(60,100,125,150), V(100), Y(100,150)	D(60,65,100,150), E(40,60,60,100), V(40,60,100)	E(200) ^M				
470	477	D(35), F(200), Y(100)	D(45,100), E(35,45,100)	D(45,60,100,200), E(45,50,60,100,200), V(40,55,100), Y(150)	E(45,50,60,100,200), V(40,60,100)					
680	687	D(35,50), E(35,50), Y(100)	D(45,60,100), E(40,60,100)	E(45,60,100), V(35,40,50)						
1000	108	E(30,40), Y(100) ^M	E(40,60), V(25,35,40,50)	E(100) ^M , V(40,50) ^M						
1500	158	D(100), E(50), V(30,40) ^M	E(50,75), V(50,75) ^M							

Not recommended for new designs, higher voltage or smaller case size substitution are offered.

Released codes ^(M tolerance only)

Engineering samples - please contact manufacturer

*Codes under development - subject to change

ESR limits quoted in brackets (milliohms)

NOTE: Voltage ratings are minimum values. AVX reserves the right to supply higher ratings in the same case size, to the same reliability standards.

RATINGS & PART NUMBER REFERENCE

AVX Part No.	Case Size	Capacitance (µF)	Rated Voltage (V)	DCL (µA) Max.	DF % Max.	ESR Max. (mΩ) @100kHz	MSL	100kHz RMS Current (A)			100kHz RMS Voltage (V)		
								25°C	85°C	125°C	25°C	85°C	125°C
2.5 Volt @ 85°C (1.7 Volt @ 125°C)													
TPSB107*002#0200	B	100	2.5	2.5	8	200	1	0.652	0.587	0.261	0.130	0.117	0.052
TPSB157*002#0150	B	150	2.5	3	10	150	1	0.753	0.677	0.301	0.113	0.102	0.045
TPSB227*002#0150	B	220	2.5	4.4	16	150	1	0.753	0.677	0.301	0.113	0.102	0.045
TPSB227*002#0200	B	220	2.5	4.4	16	200	1	0.652	0.587	0.261	0.130	0.117	0.052
TPSB227*002#0600	B	220	2.5	4.4	16	600	1	0.376	0.339	0.151	0.226	0.203	0.090
TPSD227*002#0045	D	220	2.5	5.5	8	45	1	1.826	1.643	0.730	0.082	0.074	0.033
TPSY337*002#0040	Y	330	2.5	8.2	8	40	1 ¹⁾	1.768	1.591	0.707	0.071	0.064	0.028
TPSD477*002#0035	D	470	2.5	11.6	8	35	1	2.070	1.863	0.828	0.072	0.065	0.029
TPSF477*002#0200	F	470	2.5	11.8	12	200	1	0.707	0.636	0.283	0.141	0.127	0.057
TPSY477*002#0100	Y	470	2.5	11	12	100	1 ¹⁾	1.118	1.006	0.447	0.112	0.101	0.045
TPSD687*002#0035	D	680	2.5	17	16	35	1	2.070	1.863	0.828	0.072	0.065	0.029
TPSD687*002#0050	D	680	2.5	17	16	50	1 ¹⁾	1.732	1.559	0.693	0.087	0.078	0.035
TPSE687*002#0035	E	680	2.5	17	10	35	1 ¹⁾	2.171	1.954	0.868	0.076	0.068	0.030
TPSE687*002#0050	E	680	2.5	17	10	50	1 ¹⁾	1.817	1.635	0.727	0.091	0.082	0.036
TPSY687*002#0100	Y	680	2.5	17	12	100	1 ¹⁾	1.118	1.006	0.447	0.112	0.101	0.045
TPSE108*002#0030	E	1000	2.5	25	14	30	1 ¹⁾	2.345	2.111	0.938	0.070	0.063	0.028
TPSE108*002#0040	E	1000	2.5	25	14	40	1 ¹⁾	2.031	1.828	0.812	0.081	0.073	0.032
TPSY108M002#0100	Y	1000	2.5	25	30	100	1 ¹⁾	1.118	1.006	0.447	0.112	0.101	0.045
TPSD158*002#0100	D	1500	2.5	37.5	60	100	1	1.125	1.102	0.490	0.122	0.110	0.049
TPSE158*002#0050	E	1500	2.5	37.5	20	50	1 ¹⁾	1.817	1.635	0.727	0.001	0.082	0.036
TPSV158M002#0030	V	1500	2.5	30	20	30	1 ¹⁾	2.887	2.598	1.155	0.087	0.078	0.035
TPSV158M002#0040	V	1500	2.5	30	20	40	1 ¹⁾	2.500	2.250	1.000	0.100	0.090	0.040
4 Volt @ 85°C (2.7 Volt @ 125°C)													
TPSR106*004#3000	R	10	4	0.5	6	3000	1	0.135	0.122	0.054	0.406	0.366	0.162
TPSA476*004#0500	A	47	4	1.9	8	500	1	0.387	0.349	0.155	0.194	0.174	0.077
TPSB107*004#0200	B	100	4	4	8	200	1	0.652	0.587	0.261	0.130	0.117	0.052
TPSB107*004#0250	B	100	4	4	8	250	1	0.583	0.525	0.233	0.146	0.131	0.058
TPSB107*004#0350	B	100	4	4	8	350	1	0.493	0.444	0.197	0.172	0.155	0.069
TPSB107*004#0500	B	100	4	4	8	500	1	0.412	0.371	0.165	0.206	0.186	0.082
TPSW107*004#0100	W	100	4	4	6	100	1	0.949	0.854	0.379	0.095	0.085	0.038
TPSB157*004#0250	B	150	4	6	10	250	1	0.583	0.525	0.233	0.146	0.131	0.058
TPSC157*004#0070	C	150	4	6	6	70	1	1.254	1.128	0.501	0.088	0.079	0.035
TPSC157*004#0080	C	150	4	6	6	80	1	1.173	1.055	0.469	0.094	0.084	0.038
TPSD227*004#0040	D	220	4	8.8	8	40	1	1.936	1.743	0.775	0.077	0.070	0.031
TPSD227*004#0050	D	220	4	8.8	8	50	1	1.732	1.559	0.693	0.087	0.078	0.035
TPSD227*004#0100	D	220	4	8.8	8	100	1	1.225	1.102	0.490	0.122	0.110	0.049
TPSY227*004#0040	Y	220	4	8.8	8	40	1 ¹⁾	1.768	1.591	0.707	0.071	0.064	0.028
TPSY227*004#0050	Y	220	4	8.8	8	50	1 ¹⁾	1.581	1.423	0.632	0.095	0.085	0.038
TPSY227*004#0075	Y	220	4	8.8	8	75	1 ¹⁾	1.291	1.162	0.516	0.097	0.087	0.039
TPSC337*004#0100	C	330	4	13.2	8	100	1	1.049	0.944	0.420	0.105	0.094	0.042
TPSD337*004#0035	D	330	4	13.2	8	35	1	2.070	1.863	0.828	0.072	0.065	0.029
TPSD337*004#0045	D	330	4	13.2	8	45	1	1.826	1.643	0.730	0.082	0.074	0.033
TPSD337*004#0100	D	330	4	13.2	8	100	1	1.225	1.102	0.490	0.122	0.110	0.049
TPSF337*004#0200	F	330	4	13.2	10	200	1	0.707	0.636	0.283	0.141	0.127	0.057
TPSX337*004#0100	X	330	4	13.2	8	100	1 ¹⁾	1.000	0.900	0.400	0.100	0.090	0.040
TPSD477*004#0045	D	470	4	18.8	12	45	1	1.826	1.643	0.730	0.082	0.074	0.033
TPSD477*004#0100	D	470	4	18.8	12	100	1	1.225	1.102	0.490	0.122	0.110	0.049
TPSE477*004#0035	E	470	4	18.8	10	35	1 ¹⁾	2.171	1.954	0.868	0.076	0.068	0.030
TPSE477*004#0045	E	470	4	18.8	10	45	1 ¹⁾	1.915	1.723	0.766	0.086	0.078	0.034
TPSE477*004#0100	E	470	4	18.8	10	100	1 ¹⁾	1.285	1.156	0.514	0.128	0.116	0.051
TPSD687*004#0045	D	680	4	27.2	14	45	1	1.915	1.643	0.730	0.082	0.074	0.033
TPSD687*004#0060	D	680	4	27.2	14	60	1	1.581	1.423	0.632	0.095	0.085	0.038
TPSD687*004#0100	D	680	4	27.2	14	100	1	1.225	1.102	0.490	0.122	0.110	0.049
TPSE687*004#0040	E	680	4	27.2	10	40	1 ¹⁾	2.031	1.828	0.812	0.081	0.073	0.032
TPSE687*004#0060	E	680	4	27.2	10	60	1 ¹⁾	1.658	1.492	0.663	0.099	0.090	0.040
TPSE687*004#0100	E	680	4	27.2	10	100	1 ¹⁾	1.285	1.156	0.514	0.128	0.116	0.051
TPSE108*004#0040	E	1000	4	40	14	40	1 ¹⁾	2.031	1.828	0.812	0.081	0.073	0.032
TPSE108*004#0060	E	1000	4	40	14	60	1 ¹⁾	1.658	1.492	0.663	0.099	0.090	0.040
TPSV108*004#0025	V	1000	4	40	16	25	1 ¹⁾	3.162	2.846	1.265	0.079	0.071	0.032
TPSV108*004#0035	V	1000	4	40	16	35	1 ¹⁾	2.673	2.405	1.069	0.094	0.084	0.037
TPSV108*004#0040	V	1000	4	40	16	40	1 ¹⁾	2.500	2.250	1.000	0.100	0.090	0.040
TPSV108*004#0050	V	1000	4	40	16	50	1 ¹⁾	2.236	2.012	0.894	0.112	0.101	0.045
TPSE158*004#0050	E	1500	4	60	30	50	1 ¹⁾	1.817	1.635	0.727	0.091	0.082	0.036
TPSE158*004#0075	E	1500	4	60	30	75	1 ¹⁾	1.483	1.335	0.593	0.111	0.100	0.044
TPSV158M004#0050	V	1500	4	60	30	50	1 ¹⁾	2.236	2.012	0.894	0.112	0.101	0.045
TPSV158M004#0075	V	1500	4	60	30	75	1 ¹⁾	1.826	1.643	0.730	0.137	0.123	0.055

¹⁾ Dry pack option (see How to order) recommended for reduction of stress during soldering. Dry pack parts should be treated as MSL 3.

Moisture Sensitivity Level (MSL) is defined according to J-STD-020.

For AEC-Q200 availability, please contact AVX.

All technical data relates to an ambient temperature of +25°C. Capacitance and DF are measured at 120Hz, 0.5V RMS with a maximum DC bias of 2.2 volts. DCL is measured at rated voltage after 5 minutes.

The EIA & CECC standards for low ESR Solid Tantalum Capacitors allow an ESR movement to 1.25 times catalogue limit post mounting.

For typical weight and composition see page 144.

NOTE: AVX reserves the right to supply a higher voltage rating or tighter tolerance part in the same case size, to the same reliability standards.

RATINGS & PART NUMBER REFERENCE

AVX Part No.	Case Size	Capacitance (μF)	Rated Voltage (V)	DCL (μA) Max.	DF % Max.	ESR Max. (mΩ) @100kHz	MSL	100kHz RMS Current (A)			100kHz RMS Voltage (V)		
								25°C	85°C	125°C	25°C	85°C	125°C
6.3 Volt @ 85°C (4 Volt @ 125°C)													
TPSR225*006#7000	R	2.2	6.3	0.5	6	7000	1	0.089	0.170	0.080	0.620	0.558	0.248
TPSA335*006#2100	A	3.3	6.3	0.5	6	2100	1	0.189	0.170	0.076	0.397	0.357	0.159
TPSS475*006#4000	S	4.7	6.3	0.5	6	4000	1	0.127	0.115	0.051	0.510	0.459	0.204
TPSA685*006#1800	A	6.8	6.3	0.5	6	1800	1	0.204	0.184	0.082	0.367	0.331	0.147
TPSA106*006#1500	A	10	6.3	0.6	6	1500	1	0.224	0.201	0.089	0.335	0.302	0.134
TPSB106*006#1500	B	10	6.3	0.6	6	1500	1	0.238	0.214	0.095	0.357	0.321	0.143
TPSR106*006#1000	R	10	6.3	0.6	8	1000	1	0.235	0.211	0.094	0.235	0.211	0.094
TPSR106*006#1500	R	10	6.3	0.6	8	1500	1	0.191	0.172	0.077	0.287	0.259	0.115
TPSR106*006#3000	R	10	6.3	0.6	8	3000	1	0.135	0.122	0.054	0.406	0.366	0.162
TPST106*006#1000	T	10	6.3	0.6	6	1000	1	0.283	0.255	0.113	0.283	0.255	0.113
TPSA156*006#0700	A	15	6.3	0.9	6	700	1	0.327	0.295	0.131	0.229	0.206	0.092
TPSA156*006#1500	A	15	6.3	0.9	6	1500	1	0.224	0.201	0.089	0.335	0.302	0.134
TPSA226*006#0500	A	22	6.3	1.4	6	500	1	0.387	0.349	0.155	0.194	0.174	0.077
TPSA226*006#0900	A	22	6.3	1.4	6	900	1	0.289	0.260	0.115	0.260	0.234	0.104
TPSB226*006#0375	B	22	6.3	1.4	6	375	1	0.476	0.428	0.190	0.179	0.161	0.071
TPSB226*006#0600	B	22	6.3	1.4	6	600	1	0.376	0.339	0.151	0.226	0.203	0.090
TPSC226*006#0500	C	22	6.3	1.4	6	500	1	0.469	0.422	0.188	0.235	0.211	0.094
TPSS226*006#0900	S	22	6.3	1.3	10	900	1	0.269	0.242	0.107	0.242	0.218	0.097
TPSA336*006#0600	A	33	6.3	2.1	8	600	1	0.354	0.318	0.141	0.212	0.191	0.085
TPSB336*006#0250	B	33	6.3	2.1	6	250	1	0.583	0.525	0.233	0.146	0.131	0.058
TPSB336*006#0350	B	33	6.3	2.1	6	350	1	0.493	0.444	0.197	0.172	0.155	0.069
TPSB336*006#0450	B	33	6.3	2.1	6	450	1	0.435	0.391	0.174	0.196	0.176	0.078
TPSB336*006#0600	B	33	6.3	2.1	6	600	1	0.376	0.339	0.151	0.226	0.203	0.090
TPST336*006#0800	T	33	6.3	2.1	10	800	1	0.316	0.285	0.126	0.253	0.228	0.101
TPSA476*006#0800	A	47	6.3	2.8	10	800	1	0.306	0.276	0.122	0.245	0.220	0.098
TPSB476*006#0250	B	47	6.3	3	6	250	1	0.583	0.525	0.233	0.146	0.131	0.058
TPSB476*006#0350	B	47	6.3	3	6	350	1	0.493	0.444	0.197	0.172	0.155	0.069
TPSB476*006#0500	B	47	6.3	3	6	500	1	0.412	0.371	0.165	0.206	0.186	0.082
TPSC476*006#0300	C	47	6.3	3	6	300	1	0.606	0.545	0.242	0.182	0.163	0.073
TPST476*006#1200	T	47	6.3	2.8	10	1200	1	0.258	0.232	0.103	0.310	0.279	0.124
TPSB686*006#0250	B	68	6.3	4	8	250	1	0.583	0.525	0.233	0.146	0.131	0.058
TPSB686*006#0350	B	68	6.3	4	8	350	1	0.493	0.444	0.197	0.172	0.155	0.069
TPSB686*006#0500	B	68	6.3	4	8	500	1	0.412	0.371	0.165	0.206	0.186	0.082
TPSC686*006#0150	C	68	6.3	4.3	6	150	1	0.856	0.771	0.343	0.128	0.116	0.051
TPSC686*006#0200	C	68	6.3	4.3	6	200	1	0.742	0.667	0.297	0.148	0.133	0.059
TPSW686*006#0110	W	68	6.3	4.3	6	110	1	0.905	0.814	0.362	0.099	0.090	0.040
TPSW686*006#0125	W	68	6.3	4.3	6	125	1	0.849	0.764	0.339	0.106	0.095	0.042
TPSW686*006#0250	W	68	6.3	4.3	6	250	1	0.600	0.540	0.240	0.150	0.135	0.060
TPSB107*006#0250	B	100	6.3	6.3	10	250	1	0.583	0.525	0.233	0.146	0.131	0.058
TPSB107*006#0400	B	100	6.3	6.3	10	400	1	0.461	0.415	0.184	0.184	0.166	0.074
TPSC107*006#0075	C	100	6.3	6.3	6	75	1	1.211	1.090	0.484	0.091	0.082	0.036
TPSC107*006#0150	C	100	6.3	6.3	6	150	1	0.856	0.771	0.343	0.128	0.116	0.051
TPSD107*006#0300	D	100	6.3	6.3	6	300	1	0.707	0.636	0.283	0.212	0.191	0.085
TPSW107*006#0100	W	100	6.3	6.3	6	100	1	0.949	0.854	0.379	0.095	0.085	0.038
TPSW107*006#0150	W	100	6.3	6.3	6	150	1	0.775	0.697	0.310	0.116	0.105	0.046
TPSY107*006#0100	Y	100	6.3	6.3	6	100	1 ¹⁾	1.118	1.006	0.447	0.112	0.101	0.045
TPSC157*006#0050	C	150	6.3	9.5	6	50	1	1.483	1.335	0.593	0.074	0.067	0.030
TPSC157*006#0090	C	150	6.3	9.5	6	90	1	1.106	0.995	0.442	0.099	0.090	0.040
TPSC157*006#0150	C	150	6.3	9.5	6	150	1	0.856	0.771	0.343	0.128	0.116	0.051
TPSC157*006#0200	C	150	6.3	9.5	6	200	1	0.742	0.667	0.297	0.148	0.133	0.059
TPSC157*006#0250	C	150	6.3	9.5	6	250	1	0.663	0.597	0.265	0.166	0.149	0.066
TPSD157*006#0050	D	150	6.3	9.5	6	50	1	1.732	1.559	0.693	0.087	0.078	0.035
TPSD157*006#0125	D	150	6.3	9.5	6	125	1	1.095	0.986	0.438	0.137	0.123	0.055
TPSY157*006#0040	Y	150	6.3	9.5	6	40	1 ¹⁾	1.768	1.591	0.707	0.071	0.064	0.028
TPSY157*006#0050	Y	150	6.3	9.5	6	50	1 ¹⁾	1.581	1.423	0.632	0.079	0.071	0.032
TPSC227*006#0070	C	220	6.3	13.9	8	70	1	1.254	1.128	0.501	0.088	0.079	0.035
TPSC227*006#0100	C	220	6.3	13.9	8	100	1	1.049	0.944	0.420	0.105	0.094	0.042
TPSC227*006#0125	C	220	6.3	13.9	8	125	1	0.938	0.844	0.375	0.117	0.106	0.047
TPSC227*006#0250	C	220	6.3	13.9	8	250	1	0.663	0.597	0.265	0.166	0.149	0.066
TPSD227*006#0050	D	220	6.3	13.9	8	50	1	1.732	1.559	0.693	0.087	0.078	0.035
TPSD227*006#0100	D	220	6.3	13.9	8	100	1	1.225	1.102	0.490	0.122	0.110	0.049
TPSD227*006#0125	D	220	6.3	13.9	8	125	1	1.095	0.986	0.438	0.137	0.123	0.055
TPSE227*006#0100	E	220	6.3	13.9	8	100	1 ¹⁾	1.285	1.156	0.514	0.128	0.116	0.051
TPSF227*006#0200	F	220	6.3	13.2	10	200	1	0.707	0.636	0.283	0.141	0.127	0.057
TPSY227*006#0100	Y	220	6.3	13.9	8	100	1 ¹⁾	1.118	1.006	0.447	0.112	0.101	0.045
TPSY227*006#0150	Y	220	6.3	13.9	8	150	1 ¹⁾	0.913	0.822	0.365	0.137	0.123	0.055

¹⁾ Dry pack option (see How to order) recommended for reduction of stress during soldering. Dry pack parts should be treated as MSL 3.

Moisture Sensitivity Level (MSL) is defined according to J-STD-020.

For AEC-Q200 availability, please contact AVX.

All technical data relates to an ambient temperature of +25°C. Capacitance and DF are measured at 120Hz, 0.5V RMS with a maximum DC bias of 2.2 volts. DCL is measured at rated voltage after 5 minutes.

The EIA & CECC standards for low ESR Solid Tantalum Capacitors allow an ESR movement to 1.25 times catalogue limit post mounting.

For typical weight and composition see page 144.

NOTE: AVX reserves the right to supply a higher voltage rating or tighter tolerance part in the same case size, to the same reliability standards.

TPS Series



Low ESR

RATINGS & PART NUMBER REFERENCE

AVX Part No.	Case Size	Capacitance (µF)	Rated Voltage (V)	DCL (µA) Max.	DF % Max.	ESR Max. (mΩ) @100kHz	MSL	100kHz RMS Current (A)			100kHz RMS Voltage (V)		
								25°C	85°C	125°C	25°C	85°C	125°C
TPSC337*006#0080	C	330	6.3	19.8	12	80	1	1.173	1.055	0.469	0.094	0.084	0.038
TPSC337*006#0100	C	330	6.3	19.8	12	100	1	1.049	0.944	0.420	0.105	0.094	0.042
TPSD337*006#0045	D	330	6.3	20.8	8	45	1	1.826	1.643	0.730	0.082	0.074	0.033
TPSD337*006#0050	D	330	6.3	20.8	8	50	1	1.732	1.559	0.693	0.087	0.078	0.035
TPSD337*006#0070	D	330	6.3	20.8	8	70	1	1.464	1.317	0.586	0.102	0.092	0.041
TPSD337*006#0100	D	330	6.3	20.8	8	100	1	1.225	1.102	0.490	0.122	0.110	0.049
TPSE337*006#0050	E	330	6.3	20.8	8	50	1 ¹⁾	1.817	1.635	0.727	0.091	0.082	0.036
TPSE337*006#0100	E	330	6.3	20.8	8	100	1 ¹⁾	1.285	1.156	0.514	0.128	0.116	0.051
TPSE337*006#0125	E	330	6.3	20.8	8	125	1 ¹⁾	1.149	1.034	0.460	0.144	0.129	0.057
TPSE337*006#0150	E	330	6.3	20.8	8	150	1 ¹⁾	1.049	0.944	0.420	0.157	0.142	0.063
TPSV337*006#0100	V	330	6.3	20.8	8	100	1 ¹⁾	1.581	1.423	0.632	0.158	0.142	0.063
TPSY337*006#0100	Y	330	6.3	20.8	12	100	1 ¹⁾	1.118	1.006	0.447	0.112	0.101	0.045
TPSY337*006#0150	Y	330	6.3	20.8	12	150	1 ¹⁾	0.913	0.822	0.365	0.137	0.123	0.055
TPSD477*006#0045	D	470	6.3	28	12	45	1	1.826	1.643	0.730	0.082	0.074	0.033
TPSD477*006#0060	D	470	6.3	28	12	60	1	1.581	1.423	0.632	0.095	0.085	0.038
TPSD477*006#0100	D	470	6.3	28	12	100	1	1.225	1.102	0.490	0.122	0.110	0.049
TPSD477*006#0200	D	470	6.3	28	12	200	1	0.866	0.779	0.346	0.173	0.156	0.069
TPSE477*006#0045	E	470	6.3	28	10	45	1 ¹⁾	1.915	1.723	0.766	0.086	0.078	0.034
TPSE477*006#0050	E	470	6.3	28	10	50	1 ¹⁾	1.817	1.635	0.727	0.091	0.082	0.036
TPSE477*006#0060	E	470	6.3	28	10	60	1 ¹⁾	1.658	1.492	0.663	0.099	0.090	0.040
TPSE477*006#0100	E	470	6.3	28	10	100	1 ¹⁾	1.285	1.156	0.514	0.128	0.116	0.051
TPSE477*006#0200	E	470	6.3	28	10	200	1 ¹⁾	0.908	0.817	0.363	0.182	0.163	0.073
TPSV477*006#0040	V	470	6.3	28	10	40	1 ¹⁾	2.500	2.250	1.000	0.100	0.090	0.040
TPSV477*006#0055	V	470	6.3	28	10	55	1 ¹⁾	2.132	1.919	0.853	0.117	0.106	0.047
TPSV477*006#0100	V	470	6.3	28	10	100	1 ¹⁾	1.581	1.423	0.632	0.158	0.142	0.063
TPSY477*006#0150	Y	470	6.3	28.2	20	150	1 ¹⁾	0.913	0.822	0.365	0.137	0.123	0.055
TPSE687*006#0045	E	680	6.3	42.8	10	45	1 ¹⁾	1.915	1.723	0.766	0.086	0.078	0.034
TPSE687*006#0060	E	680	6.3	42.8	10	60	1 ¹⁾	1.658	1.492	0.663	0.099	0.090	0.040
TPSE687*006#0100	E	680	6.3	42.8	10	100	1 ¹⁾	1.285	1.156	0.514	0.128	0.116	0.051
TPSV687*006#0035	V	680	6.3	42.8	14	35	1 ¹⁾	2.673	2.405	1.069	0.094	0.084	0.037
TPSV687*006#0040	V	680	6.3	42.8	10	40	1 ¹⁾	2.500	2.250	1.000	0.100	0.090	0.040
TPSV687*006#0050	V	680	6.3	42.8	10	50	1 ¹⁾	2.236	2.012	0.894	0.112	0.101	0.045
TPSE108M006#0100	E	1000	6.3	60	20	100	1 ¹⁾	1.285	1.156	0.514	0.128	0.116	0.051
TPSV108M006#0040	V	1000	6.3	60	16	40	1 ¹⁾	2.500	2.250	1.000	0.100	0.090	0.040
TPSV108M006#0050	V	1000	6.3	60	16	50	1 ¹⁾	2.236	2.012	0.894	0.112	0.101	0.045
10 Volt @ 85°C (7 Volt @ 125°C)													
TPSR105*010#9000	R	1	10	0.5	4	9000	1	0.078	0.078	0.070	0.704	0.633	0.281
TPSA225*010#1800	A	2.2	10	0.5	6	1800	1	0.204	0.184	0.082	0.367	0.331	0.147
TPST335*010#1500	T	3.3	10	0.5	6	1500	1	0.231	0.208	0.092	0.346	0.312	0.139
TPSA475*010#1400	A	4.7	10	0.5	6	1400	1	0.231	0.208	0.093	0.324	0.292	0.130
TPSB475*010#1400	B	4.7	10	0.5	6	1400	1	0.246	0.222	0.099	0.345	0.310	0.138
TPSR475*010#3000	R	4.7	10	0.5	6	3000	1	0.135	0.122	0.054	0.406	0.366	0.162
TPSR475*010#5000	R	4.7	10	0.5	6	5000	1	0.105	0.094	0.042	0.524	0.472	0.210
TPSA685*010#1800	A	6.8	10	0.7	6	1800	1	0.204	0.184	0.082	0.367	0.331	0.147
TPSB685*010#1300	B	6.8	10	0.7	6	1300	1	0.256	0.230	0.102	0.332	0.299	0.133
TPST685*010#1800	T	6.8	10	0.7	6	1800	1	0.211	0.190	0.084	0.379	0.342	0.152
TPSA106*010#0900	A	10	10	1	6	900	1	0.289	0.260	0.115	0.260	0.234	0.104
TPSA106*010#1800	A	10	10	1	6	1800	1	0.204	0.184	0.082	0.367	0.331	0.147
TPSB106*010#1000	B	10	10	1	6	1000	1	0.292	0.262	0.117	0.292	0.262	0.117
TPSP106M010#2000	P	10	10	1	8	2000	1	0.173	0.156	0.069	0.346	0.312	0.139
TPST106*010#0900	S	10	10	1	8	900	1	0.269	0.242	0.107	0.242	0.218	0.097
TPST106*010#1000	T	10	10	1	6	1000	1	0.283	0.255	0.113	0.283	0.255	0.113
TPST106*010#2000	T	10	10	1	6	2000	1	0.200	0.180	0.080	0.400	0.360	0.160
TPSA156*010#1000	A	15	10	1.5	6	1000	1	0.274	0.246	0.110	0.274	0.246	0.110
TPSB156*010#0450	B	15	10	1.5	6	450	1	0.435	0.391	0.174	0.196	0.176	0.078
TPSB156*010#0600	B	15	10	1.5	6	600	1	0.376	0.339	0.151	0.226	0.203	0.090
TPSC156*010#0700	C	15	10	1.5	6	700	1	0.396	0.357	0.159	0.277	0.250	0.111
TPST156*010#1200	T	15	10	1.5	8	1200	1	0.258	0.232	0.103	0.310	0.279	0.124
TPSA226*010#0900	A	22	10	2.2	8	900	1	0.289	0.260	0.115	0.260	0.234	0.104
TPSB226*010#0400	B	22	10	2.2	6	400	1	0.461	0.415	0.184	0.184	0.166	0.074
TPSB226*010#0500	B	22	10	2.2	6	500	1	0.412	0.371	0.165	0.206	0.186	0.082
TPSB226*010#0700	B	22	10	2.2	6	700	1	0.348	0.314	0.139	0.244	0.220	0.098
TPSC226*010#0300	C	22	10	2.2	6	300	1	0.606	0.545	0.242	0.182	0.163	0.073
TPST226*010#0800	T	22	10	2.2	8	800	1	0.316	0.285	0.126	0.253	0.228	0.101
TPSA336*010#0700	A	33	10	3.3	8	700	1	0.327	0.295	0.131	0.229	0.206	0.092
TPSB336*010#0250	B	33	10	3.3	6	250	1	0.583	0.525	0.233	0.146	0.131	0.058
TPSB336*010#0425	B	33	10	3.3	6	425	1	0.447	0.402	0.179	0.190	0.171	0.076
TPSB336*010#0500	B	33	10	3.3	6	500	1	0.412	0.371	0.165	0.206	0.186	0.082
TPSB336*010#0650	B	33	10	3.3	6	650	1	0.362	0.325	0.145	0.235	0.212	0.094

¹⁾ Dry pack option (see How to order) recommended for reduction of stress during soldering. Dry pack parts should be treated as MSL 3.

Moisture Sensitivity Level (MSL) is defined according to J-STD-020.

For AEC-Q200 availability, please contact AVX.

All technical data relates to an ambient temperature of +25°C. Capacitance and DF are measured at 120Hz, 0.5V RMS with a maximum DC bias of 2.2 volts.

DCL is measured at rated voltage after 5 minutes.

The EIA & CECC standards for low ESR Solid Tantalum Capacitors allow an ESR movement to 1.25 times catalogue limit post mounting.

For typical weight and composition see page 144.

NOTE: AVX reserves the right to supply a higher voltage rating or tighter tolerance part in the same case size, to the same reliability standards.



RATINGS & PART NUMBER REFERENCE

AVX Part No.	Case Size	Capacitance (µF)	Rated Voltage (V)	DCL (µA) Max.	DF % Max.	ESR Max. (mΩ) @100kHz	MSL	100kHz RMS Current (A)			100kHz RMS Voltage (V)		
								25°C	85°C	125°C	25°C	85°C	125°C
TPSC336*010#0150	C	33	10	3.3	6	150	1	0.856	0.771	0.343	0.128	0.116	0.051
TPSC336*010#0375	C	33	10	3.3	6	375	1	0.542	0.487	0.217	0.203	0.183	0.081
TPSC336*010#0500	C	33	10	3.3	6	500	1	0.469	0.422	0.188	0.235	0.211	0.094
TPSW336*010#0350	W	33	10	3.3	6	350	1	0.507	0.456	0.203	0.177	0.160	0.071
TPSB476*010#0250	B	47	10	4.7	8	250	1	0.583	0.525	0.233	0.146	0.131	0.058
TPSB476*010#0350	B	47	10	4.7	8	350	1	0.493	0.444	0.197	0.172	0.155	0.069
TPSB476*010#0500	B	47	10	4.7	8	500	1	0.412	0.371	0.165	0.206	0.186	0.082
TPSB476*010#0650	B	47	10	4.7	8	650	1	0.362	0.325	0.145	0.235	0.212	0.094
TPSC476*010#0200	C	47	10	4.7	6	200	1	0.742	0.667	0.297	0.148	0.133	0.059
TPSC476*010#0350	C	47	10	4.7	6	350	1	0.561	0.505	0.224	0.196	0.177	0.078
TPSD476*010#0100	D	47	10	4.7	6	100	1	1.225	1.102	0.490	0.122	0.110	0.049
TPSD476*010#0300	D	47	10	4.7	6	300	1	0.707	0.636	0.283	0.212	0.191	0.085
TPSW476*010#0125	W	47	10	4.7	6	125	1	0.849	0.764	0.339	0.106	0.095	0.042
TPSW476*010#0150	W	47	10	4.7	6	150	1	0.775	0.697	0.310	0.116	0.105	0.046
TPSW476*010#0250	W	47	10	4.7	6	250	1	0.600	0.540	0.240	0.150	0.135	0.060
TPSB686*010#0600	B	68	10	6.8	8	600	1	0.376	0.339	0.151	0.226	0.203	0.090
TPSC686*010#0080	C	68	10	6.8	6	80	1	1.173	1.055	0.469	0.094	0.084	0.038
TPSC686*010#0100	C	68	10	6.8	6	100	1	1.049	0.944	0.420	0.105	0.094	0.042
TPSC686*010#0200	C	68	10	6.8	6	200	1	0.742	0.667	0.297	0.148	0.133	0.059
TPSC686*010#0300	C	68	10	6.8	6	300	1	0.606	0.545	0.242	0.182	0.163	0.073
TPSD686*010#0100	D	68	10	6.8	6	100	1	1.225	1.102	0.490	0.122	0.110	0.049
TPSD686*010#0150	D	68	10	6.8	6	150	1	1.000	0.900	0.400	0.150	0.135	0.060
TPSY686*010#0100	Y	68	10	6.8	6	100	1 ¹⁾	1.118	1.006	0.447	0.112	0.101	0.045
TPSY686*010#0200	Y	68	10	6.8	6	200	1 ¹⁾	0.791	0.712	0.316	0.158	0.142	0.063
TPSW686*010#0100	W	68	10	6.8	6	100	1	0.949	0.854	0.379	0.095	0.085	0.038
TPSW686*010#0150	W	68	10	6.8	6	150	1	0.775	0.697	0.310	0.116	0.105	0.046
TPSB107M010#0400	B	100	10	10	8	400	1	0.461	0.415	0.184	0.184	0.166	0.074
TPSC107*010#0075	C	100	10	10	8	75	1	1.211	1.090	0.484	0.091	0.082	0.036
TPSC107*010#0100	C	100	10	10	8	100	1	1.049	0.944	0.420	0.105	0.094	0.042
TPSC107*010#0150	C	100	10	10	8	150	1	0.856	0.771	0.343	0.128	0.116	0.051
TPSC107*010#0200	C	100	10	10	8	200	1	0.742	0.667	0.297	0.148	0.133	0.059
TPSD107*010#0050	D	100	10	10	6	50	1	1.732	1.559	0.693	0.087	0.078	0.035
TPSD107*010#0065	D	100	10	10	6	65	1	1.519	1.367	0.608	0.099	0.089	0.039
TPSD107*010#0080	D	100	10	10	6	80	1	1.369	1.232	0.548	0.110	0.099	0.044
TPSD107*010#0100	D	100	10	10	6	100	1	1.225	1.102	0.490	0.122	0.110	0.049
TPSD107*010#0125	D	100	10	10	6	125	1	1.095	0.986	0.438	0.137	0.123	0.055
TPSD107*010#0150	D	100	10	10	6	150	1	1.000	0.900	0.400	0.150	0.135	0.060
TPSE107*010#0125	E	100	10	10	6	125	1 ¹⁾	1.149	1.034	0.460	0.144	0.129	0.057
TPSW107*010#0150	W	100	10	10	6	150	1	0.775	0.697	0.310	0.116	0.105	0.046
TPSX107*010#0085	X	100	10	10	8	85	1 ¹⁾	1.085	0.976	0.434	0.092	0.083	0.037
TPSX107*010#0150	X	100	10	10	8	150	1 ¹⁾	0.816	0.735	0.327	0.122	0.110	0.049
TPSX107*010#0200	X	100	10	10	8	200	1 ¹⁾	0.707	0.636	0.283	0.141	0.127	0.057
TPSY107*010#0100	Y	100	10	10	6	100	1 ¹⁾	1.118	1.006	0.447	0.112	0.101	0.045
TPSY107*010#0150	Y	100	10	10	6	150	1 ¹⁾	0.913	0.822	0.365	0.137	0.123	0.055
TPSY107*010#0200	Y	100	10	10	6	200	1 ¹⁾	0.791	0.712	0.316	0.158	0.142	0.063
TPSC157*010#0150	C	150	10	15	8	150	1	0.856	0.771	0.343	0.128	0.116	0.051
TPSD157*010#0050	D	150	10	15	8	50	1	1.732	1.559	0.693	0.087	0.078	0.035
TPSD157*010#0085	D	150	10	15	8	85	1	1.328	1.196	0.531	0.113	0.102	0.045
TPSD157*010#0100	D	150	10	15	8	100	1	1.225	1.102	0.490	0.122	0.110	0.049
TPSE157*010#0100	E	150	10	15	8	100	1 ¹⁾	1.285	1.156	0.514	0.128	0.116	0.051
TPSF157*010#0200	F	150	10	15	10	200	1	0.707	0.636	0.283	0.141	0.127	0.057
TPSX157M010#0100	X	150	10	15	6	100	1 ¹⁾	1.000	0.900	0.400	0.100	0.090	0.040
TPSY157*010#0100	Y	150	10	15	6	100	1 ¹⁾	1.118	1.006	0.447	0.112	0.101	0.045
TPSY157*010#0150	Y	150	10	15	6	150	1 ¹⁾	0.913	0.822	0.365	0.137	0.123	0.055
TPSY157*010#0200	Y	150	10	15	6	200	1 ¹⁾	0.791	0.712	0.316	0.158	0.142	0.063
TPSD227*010#0050	D	220	10	22	8	50	1	1.732	1.559	0.693	0.087	0.078	0.035
TPSD227*010#0100	D	220	10	22	8	100	1	1.225	1.102	0.490	0.122	0.110	0.049
TPSD227*010#0150	D	220	10	22	8	150	1	1.000	0.900	0.400	0.150	0.135	0.060
TPSE227*010#0050	E	220	10	22	8	50	1 ¹⁾	1.817	1.635	0.727	0.091	0.082	0.036
TPSE227*010#0060	E	220	10	22	8	60	1 ¹⁾	1.658	1.492	0.663	0.099	0.090	0.040
TPSE227*010#0070	E	220	10	22	8	70	1 ¹⁾	1.535	1.382	0.614	0.107	0.097	0.043
TPSE227*010#0100	E	220	10	22	8	100	1 ¹⁾	1.285	1.156	0.514	0.128	0.116	0.051
TPSE227*010#0125	E	220	10	22	8	125	1 ¹⁾	1.149	1.034	0.460	0.144	0.129	0.057
TPSE227*010#0150	E	220	10	22	8	150	1 ¹⁾	1.049	0.944	0.420	0.157	0.142	0.063
TPSY227*010#0100	Y	220	10	22	10	100	1 ¹⁾	1.118	1.006	0.447	0.112	0.101	0.045
TPSY227*010#0150	Y	220	10	22	10	150	1 ¹⁾	0.913	0.822	0.365	0.137	0.123	0.055
TPSY227*010#0200	Y	220	10	22	10	200	1 ¹⁾	0.791	0.712	0.316	0.158	0.142	0.063
TPSD337*010#0050	D	330	10	33	8	50	1	1.732	1.559	0.693	0.087	0.078	0.035

¹⁾ Dry pack option (see How to order) recommended for reduction of stress during soldering. Dry pack parts should be treated as MSL 3.

Moisture Sensitivity Level (MSL) is defined according to J-STD-020.

For AEC-Q200 availability, please contact AVX.

All technical data relates to an ambient temperature of +25°C. Capacitance and DF are measured at 120Hz, 0.5V RMS with a maximum DC bias of 2.2 volts.

DCL is measured at rated voltage after 5 minutes.

The EIA & CECC standards for low ESR Solid Tantalum Capacitors allow an ESR movement to 1.25 times catalogue limit post mounting.

For typical weight and composition see page 144.

NOTE: AVX reserves the right to supply a higher voltage rating or tighter tolerance part in the same case size, to the same reliability standards.

RATINGS & PART NUMBER REFERENCE

AVX Part No.	Case Size	Capacitance (µF)	Rated Voltage (V)	DCL (µA) Max.	DF % Max.	ESR Max. (mΩ) @100kHz	MSL	100kHz RMS Current (A)			100kHz RMS Voltage (V)		
								25°C	85°C	125°C	25°C	85°C	125°C
TPSD337*010#0065	D	330	10	33	8	65	1	1.519	1.367	0.608	0.099	0.089	0.039
TPSD337*010#0100	D	330	10	33	8	100	1	1.225	1.102	0.490	0.122	0.110	0.049
TPSD337*010#0150	D	330	10	33	8	150	1	1.000	0.900	0.400	0.150	0.135	0.060
TPSE337*010#0040	E	330	10	33	8	40	1 ¹⁾	2.031	1.828	0.812	0.081	0.073	0.032
TPSE337*010#0050	E	330	10	33	8	50	1 ¹⁾	1.817	1.635	0.727	0.091	0.082	0.036
TPSE337*010#0060	E	330	10	33	8	60	1 ¹⁾	1.658	1.492	0.663	0.099	0.090	0.040
TPSE337*010#0100	E	330	10	33	8	100	1 ¹⁾	1.285	1.156	0.514	0.128	0.116	0.051
TPSV337*010#0040	V	330	10	33	10	40	1 ¹⁾	2.500	2.250	1.000	0.100	0.090	0.040
TPSV337*010#0060	V	330	10	33	10	60	1 ¹⁾	2.041	1.837	0.816	0.122	0.110	0.049
TPSV337*010#0100	V	330	10	33	10	100	1 ¹⁾	1.581	1.423	0.632	0.158	0.142	0.063
TPSE477*010#0045	E	470	10	47	10	45	1 ¹⁾	1.915	1.723	0.766	0.086	0.078	0.034
TPSE477*010#0050	E	470	10	47	10	50	1 ¹⁾	1.817	1.635	0.727	0.091	0.082	0.036
TPSE477*010#0060	E	470	10	47	10	60	1 ¹⁾	1.658	1.492	0.663	0.099	0.090	0.040
TPSE477*010#0100	E	470	10	47	10	100	1 ¹⁾	1.285	1.156	0.514	0.128	0.116	0.051
TPSE477*010#0200	E	470	10	47	10	200	1 ¹⁾	0.908	0.817	0.363	0.182	0.163	0.073
TPSV477*010#0040	V	470	10	47	10	40	1 ¹⁾	2.500	2.250	1.000	0.100	0.090	0.040
TPSV477*010#0060	V	470	10	47	10	60	1 ¹⁾	2.041	1.837	0.816	0.122	0.110	0.049
TPSV477*010#0100	V	470	10	47	10	100	1 ¹⁾	1.581	1.423	0.632	0.158	0.142	0.063
16 Volt @ 85°C (10 Volt @ 125°C)													
TPSA105*016#6200	A	1	16	0.5	4	6200	1	0.110	0.099	0.044	0.682	0.614	0.273
TPSA225*016#1800	A	2.2	16	0.5	6	1800	1	0.204	0.184	0.082	0.367	0.331	0.147
TPSA225*016#3500	A	2.2	16	0.5	6	3500	1	0.146	0.132	0.059	0.512	0.461	0.205
TPST225*016#2000	T	2.2	16	0.5	6	2000	1	0.200	0.180	0.080	0.400	0.360	0.160
TPSA335*016#3500	A	3.3	16	0.5	6	3500	1	0.146	0.132	0.059	0.512	0.461	0.205
TPSB335*016#2500	B	3.3	16	0.5	6	2500	1	0.184	0.166	0.074	0.461	0.415	0.184
TPSA475*016#2000	A	4.7	16	0.8	6	2000	1	0.194	0.174	0.077	0.387	0.349	0.155
TPSB475*016#0800	B	4.7	16	0.8	6	800	1	0.326	0.293	0.130	0.261	0.235	0.104
TPSB475*016#1500	B	4.7	16	0.8	6	1500	1	0.238	0.214	0.095	0.357	0.321	0.143
TPSA685*016#1500	A	6.8	16	1.1	6	1500	1	0.224	0.201	0.089	0.335	0.302	0.134
TPSB685*016#0600	B	6.8	16	1.1	6	600	1	0.376	0.339	0.151	0.226	0.203	0.090
TPSB685*016#1200	B	6.8	16	1.1	6	1200	1	0.266	0.240	0.106	0.319	0.287	0.128
TPSA106*016#1000	A	10	16	1.6	6	1000	1	0.274	0.246	0.110	0.274	0.246	0.110
TPSB106*016#0500	B	10	16	1.6	6	500	1	0.412	0.371	0.165	0.206	0.186	0.082
TPSB106*016#0800	B	10	16	1.6	6	800	1	0.326	0.293	0.130	0.261	0.235	0.104
TPSC106*016#0500	C	10	16	1.6	6	500	1	0.469	0.422	0.188	0.235	0.211	0.094
TPST106*016#0800	T	10	16	1.6	8	800	1	0.316	0.285	0.126	0.253	0.228	0.101
TPST106*016#1000	T	10	16	1.6	8	1000	1	0.283	0.255	0.113	0.283	0.255	0.113
TPSW106*016#0500	W	10	16	1.6	6	500	1	0.424	0.382	0.170	0.212	0.191	0.085
TPSW106*016#0600	W	10	16	1.6	6	600	1	0.387	0.349	0.155	0.232	0.209	0.093
TPSB156*016#0500	B	15	16	2.4	6	500	1	0.412	0.371	0.165	0.206	0.186	0.082
TPSB156*016#0800	B	15	16	2.4	6	800	1	0.326	0.293	0.130	0.261	0.235	0.104
TPSC156*016#0700	C	15	16	2.4	6	700	1	0.396	0.357	0.159	0.277	0.250	0.111
TPSB226*016#0400	B	22	16	3.5	6	400	1	0.461	0.415	0.184	0.184	0.166	0.074
TPSB226*016#0600	B	22	16	3.5	6	600	1	0.376	0.339	0.151	0.226	0.203	0.090
TPSC226*016#0150	C	22	16	3.5	6	150	1	0.856	0.771	0.343	0.128	0.116	0.051
TPSC226*016#0250	C	22	16	3.5	6	250	1	0.663	0.597	0.265	0.166	0.149	0.066
TPSC226*016#0300	C	22	16	3.5	6	300	1	0.606	0.545	0.242	0.182	0.163	0.073
TPSC226*016#0375	C	22	16	3.5	6	375	1	0.542	0.487	0.217	0.203	0.183	0.081
TPSD226*016#0700	D	22	16	3.5	6	700	1	0.463	0.417	0.185	0.324	0.292	0.130
TPSW226*016#0500	W	22	16	3.5	6	500	1	0.424	0.382	0.170	0.212	0.191	0.085
TPSB336*016#0350	B	33	16	5.3	8	350	1	0.493	0.444	0.197	0.172	0.155	0.069
TPSB336*016#0500	B	33	16	5.3	8	500	1	0.412	0.371	0.165	0.206	0.186	0.082
TPSC336*016#0100	C	33	16	5.3	6	100	1	1.049	0.944	0.420	0.105	0.094	0.042
TPSC336*016#0150	C	33	16	5.3	6	150	1	0.856	0.771	0.343	0.128	0.116	0.051
TPSC336*016#0225	C	33	16	5.3	6	225	1	0.699	0.629	0.280	0.157	0.142	0.063
TPSC336*016#0300	C	33	16	5.3	6	300	1	0.606	0.545	0.242	0.182	0.163	0.073
TPSD336*016#0200	D	33	16	5.3	6	200	1	0.866	0.779	0.346	0.173	0.156	0.069
TPSW336*016#0140	W	33	16	5.3	6	140	1	0.802	0.722	0.321	0.112	0.101	0.045
TPSW336*016#0175	W	33	16	5.3	6	175	1	0.717	0.645	0.287	0.125	0.113	0.050
TPSW336*016#0250	W	33	16	5.3	6	250	1	0.600	0.540	0.240	0.150	0.135	0.060
TPSW336*016#0400	W	33	16	5.3	6	400	1	0.474	0.427	0.190	0.190	0.171	0.076
TPSW336*016#0500	W	33	16	5.3	6	500	1	0.424	0.382	0.170	0.212	0.191	0.085
TPSY336*016#0300	Y	33	16	5.3	6	300	1 ¹⁾	0.645	0.581	0.258	0.194	0.174	0.077
TPSY336*016#0400	Y	33	16	5.3	6	400	1 ¹⁾	0.559	0.503	0.224	0.224	0.201	0.089
TPSC476*016#0110	C	47	16	7.5	6	110	1	1.000	0.900	0.400	0.110	0.099	0.044
TPSC476*016#0350	C	47	16	7.5	6	350	1	0.561	0.505	0.224	0.196	0.177	0.078
TPSD476*016#0080	D	47	16	7.5	6	80	1	1.369	1.232	0.548	0.110	0.099	0.044

¹⁾ Dry pack option (see How to order) recommended for reduction of stress during soldering. Dry pack parts should be treated as MSL 3.

Moisture Sensitivity Level (MSL) is defined according to J-STD-020.

For AEC-Q200 availability, please contact AVX.

All technical data relates to an ambient temperature of +25°C. Capacitance and DF are measured at 120Hz, 0.5V RMS with a maximum DC bias of 2.2 volts. DCL is measured at rated voltage after 5 minutes.

The EIA & CECC standards for low ESR Solid Tantalum Capacitors allow an ESR movement to 1.25 times catalogue limit post mounting.

For typical weight and composition see page 144.

NOTE: AVX reserves the right to supply a higher voltage rating or tighter tolerance part in the same case size, to the same reliability standards.

RATINGS & PART NUMBER REFERENCE

AVX Part No.	Case Size	Capacitance (µF)	Rated Voltage (V)	DCL (µA) Max.	DF % Max.	ESR Max. (mΩ) @100kHz	MSL	100kHz RMS Current (A)			100kHz RMS Voltage (V)		
								25°C	85°C	125°C	25°C	85°C	125°C
TPSD476*016#0100	D	47	16	7.5	6	100	1	1.225	1.102	0.490	0.122	0.110	0.049
TPSD476*016#0150	D	47	16	7.5	6	150	1	1.000	0.900	0.400	0.150	0.135	0.060
TPSD476*016#0200	D	47	16	7.5	6	200	1	0.866	0.779	0.346	0.173	0.156	0.069
TPSW476*016#0200	W	47	16	7.5	6	200	1	0.671	0.604	0.268	0.134	0.121	0.054
TPSX476*016#0180	X	47	16	7.5	6	180	1 ¹⁾	0.745	0.671	0.298	0.134	0.121	0.054
TPSY476*016#0250	Y	47	16	7.5	6	250	1 ¹⁾	0.707	0.636	0.283	0.177	0.159	0.071
TPSC686*016#0125	C	68	16	10.9	6	125	1	0.938	0.844	0.375	0.117	0.106	0.047
TPSC686*016#0200	C	68	16	10.9	6	200	1	0.742	0.667	0.297	0.148	0.133	0.059
TPSD686*016#0070	D	68	16	10.9	6	70	1	1.464	1.317	0.586	0.102	0.092	0.041
TPSD686*016#0100	D	68	16	10.9	6	100	1	1.225	1.102	0.490	0.122	0.110	0.049
TPSD686*016#0150	D	68	16	10.9	6	150	1	1.000	0.900	0.400	0.150	0.135	0.060
TPSF686*016#0200	F	68	16	10.9	10	200	1	0.707	0.636	0.283	0.141	0.127	0.057
TPSX686*016#0150	X	68	16	10.9	8	150	1 ¹⁾	0.816	0.735	0.327	0.122	0.110	0.049
TPSY686*016#0150	Y	68	16	10.9	6	150	1 ¹⁾	0.913	0.822	0.365	0.137	0.123	0.055
TPSY686*016#0200	Y	68	16	10.9	6	200	1 ¹⁾	0.791	0.712	0.316	0.158	0.142	0.063
TPSY686*016#0250	Y	68	16	10.9	6	250	1 ¹⁾	0.707	0.636	0.283	0.177	0.159	0.071
TPSC107*016#0200	C	100	16	16	8	200	1	0.742	0.667	0.297	0.148	0.133	0.059
TPSD107*016#0060	D	100	16	16	6	60	1	1.581	1.423	0.632	0.095	0.085	0.038
TPSD107*016#0100	D	100	16	16	6	100	1	1.225	1.102	0.490	0.122	0.110	0.049
TPSD107*016#0125	D	100	16	16	6	125	1	1.095	0.986	0.438	0.137	0.123	0.055
TPSD107*016#0150	D	100	16	16	6	150	1	1.000	0.900	0.400	0.150	0.135	0.060
TPSE107*016#0055	E	100	16	16	6	55	1 ¹⁾	1.732	1.559	0.693	0.095	0.086	0.038
TPSE107*016#0100	E	100	16	16	6	100	1 ¹⁾	1.285	1.156	0.514	0.128	0.116	0.051
TPSE107*016#0125	E	100	16	16	6	125	1 ¹⁾	1.149	1.034	0.460	0.144	0.129	0.057
TPSE107*016#0150	E	100	16	16	6	150	1 ¹⁾	1.049	0.944	0.420	0.157	0.142	0.063
TPSF107M016#0150	F	100	16	16	10	150	1	0.816	0.735	0.327	0.122	0.110	0.049
TPSF107M016#0200	F	100	16	16	10	200	1	0.707	0.636	0.283	0.141	0.127	0.057
TPSY107*016#0100	Y	100	16	16	8	100	1 ¹⁾	1.118	1.006	0.447	0.112	0.101	0.045
TPSY107*016#0150	Y	100	16	16	8	150	1 ¹⁾	0.913	0.822	0.365	0.137	0.123	0.055
TPSY107*016#0200	Y	100	16	16	8	200	1 ¹⁾	0.791	0.712	0.316	0.158	0.142	0.063
TPSD157*016#0060	D	150	16	24	6	60	1	1.581	1.423	0.632	0.095	0.085	0.038
TPSD157*016#0085	D	150	16	24	6	85	1	1.328	1.196	0.531	0.113	0.102	0.045
TPSD157*016#0100	D	150	16	24	6	100	1	1.225	1.102	0.490	0.122	0.110	0.049
TPSD157*016#0125	D	150	16	24	6	125	1	1.095	0.986	0.438	0.137	0.123	0.055
TPSD157*016#0150	D	150	16	24	6	150	1	1.000	0.900	0.400	0.150	0.135	0.060
TPSE157*016#0100	E	150	16	23	8	100	1 ¹⁾	1.285	1.156	0.514	0.128	0.116	0.051
TPSV157*016#0045	V	150	16	24	8	45	1 ¹⁾	2.357	2.121	0.943	0.106	0.095	0.042
TPSV157*016#0075	V	150	16	24	8	75	1 ¹⁾	1.826	1.643	0.730	0.137	0.123	0.055
TPSY157M016#0200	Y	150	16	24	15	200	1 ¹⁾	0.791	0.712	0.316	0.158	0.142	0.063
TPSE227*016#0100	E	220	16	35.2	10	100	1 ¹⁾	1.285	1.156	0.514	0.128	0.116	0.051
TPSE227*016#0150	E	220	16	35.2	10	150	1 ¹⁾	1.049	0.944	0.420	0.157	0.142	0.063
TPSV227*016#0050	V	220	16	35.2	8	50	1 ¹⁾	2.236	2.012	0.894	0.112	0.101	0.045
TPSV227*016#0075	V	220	16	35.2	8	75	1 ¹⁾	1.826	1.643	0.730	0.137	0.123	0.055
TPSV227*016#0100	V	220	16	35.2	8	100	1 ¹⁾	1.581	1.423	0.632	0.158	0.142	0.063
TPSV227*016#0150	V	220	16	35.2	8	150	1 ¹⁾	1.291	1.162	0.516	0.194	0.174	0.077
TPSE337M016#0200	E	330	16	52.8	30	200	1 ¹⁾	0.908	0.817	0.363	0.182	0.163	0.073
20 Volt @ 85°C (13 Volt @ 125°C)													
TPSA105*020#3000	A	1	20	0.5	4	3000	1	0.158	0.142	0.063	0.474	0.427	0.190
TPSR105*020#6000	R	1	20	0.5	4	6000	1	0.096	0.086	0.038	0.574	0.517	0.230
TPSS105*020#6000	S	1	20	0.5	4	6000	1	0.104	0.094	0.042	0.624	0.562	0.250
TPST105*020#2000	T	1	20	0.5	4	2000	1	0.200	0.180	0.080	0.400	0.360	0.160
TPSA155*020#3000	A	1.5	20	0.5	6	3000	1	0.158	0.142	0.063	0.474	0.427	0.190
TPSA225*020#3000	A	2.2	20	0.5	6	3000	1	0.158	0.142	0.063	0.474	0.427	0.190
TPSB225*020#1700	B	2.2	20	0.5	6	1700	1	0.224	0.201	0.089	0.380	0.342	0.152
TPSA335*020#2500	A	3.3	20	0.7	6	2500	1	0.173	0.156	0.069	0.433	0.390	0.173
TPSB335*020#1300	B	3.3	20	0.7	6	1300	1	0.256	0.230	0.102	0.332	0.299	0.133
TPSA475*020#1800	A	4.7	20	0.9	6	1800	1	0.204	0.184	0.082	0.367	0.331	0.147
TPSB475*020#0750	B	4.7	20	0.9	6	750	1	0.337	0.303	0.135	0.252	0.227	0.101
TPSB475*020#1000	B	4.7	20	0.9	6	1000	1	0.292	0.262	0.117	0.292	0.262	0.117
TPSA685*020#1000	A	6.8	20	1.4	6	1000	1	0.274	0.246	0.110	0.274	0.246	0.110
TPSB685*020#0600	B	6.8	20	1.4	6	600	1	0.376	0.339	0.151	0.226	0.203	0.090
TPSB685*020#1000	B	6.8	20	1.4	6	1000	1	0.292	0.262	0.117	0.292	0.262	0.117
TPSC685*020#0700	C	6.8	20	1.4	6	700	1	0.396	0.357	0.159	0.277	0.250	0.111
TPSB106*020#0500	B	10	20	2	6	500	1	0.412	0.371	0.165	0.206	0.186	0.082
TPSB106*020#1000	B	10	20	2	6	1000	1	0.292	0.262	0.117	0.292	0.262	0.117
TPSC106*020#0500	C	10	20	2	6	500	1	0.469	0.422	0.188	0.235	0.211	0.094
TPSC106*020#0700	C	10	20	2	6	700	1	0.396	0.357	0.159	0.277	0.250	0.111

¹⁾ Dry pack option (see How to order) recommended for reduction of stress during soldering. Dry pack parts should be treated as MSL 3. Moisture Sensitivity Level (MSL) is defined according to J-STD-020.
 For AEC-Q200 availability, please contact AVX.
 All technical data relates to an ambient temperature of +25°C. Capacitance and DF are measured at 120Hz, 0.5V RMS with a maximum DC bias of 2.2 volts. DCL is measured at rated voltage after 5 minutes.
 The EIA & CECC standards for low ESR Solid Tantalum Capacitors allow an ESR movement to 1.25 times catalogue limit post mounting.
 For typical weight and composition see page 144.
NOTE: AVX reserves the right to supply a higher voltage rating or tighter tolerance part in the same case size, to the same reliability standards.

RATINGS & PART NUMBER REFERENCE

AVX Part No.	Case Size	Capacitance (µF)	Rated Voltage (V)	DCL (µA) Max.	DF % Max.	ESR Max. (mΩ) @100kHz	MSL	100kHz RMS Current (A)			100kHz RMS Voltage (V)		
								25°C	85°C	125°C	25°C	85°C	125°C
TPSW106*020#0250	W	10	20	2	6	250	1	0.600	0.540	0.240	0.150	0.135	0.060
TPSW106*020#0500	W	10	20	2	6	500	1	0.424	0.382	0.170	0.212	0.191	0.0850
TPSB156*020#0500	B	15	20	3	6	500	1	0.412	0.371	0.165	0.206	0.186	0.082
TPSC156*020#0400	C	15	20	3	6	400	1	0.524	0.472	0.210	0.210	0.189	0.084
TPSC156*020#0450	C	15	20	3	6	450	1	0.494	0.445	0.198	0.222	0.200	0.089
TPSB226*020#0400	B	22	20	4.4	6	400	1	0.461	0.415	0.184	0.184	0.166	0.074
TPSB226*020#0600	B	22	20	4.4	6	600	1	0.376	0.339	0.151	0.226	0.203	0.090
TPSC226*020#0100	C	22	20	4.4	6	100	1	1.049	0.944	0.420	0.105	0.094	0.042
TPSC226*020#0150	C	22	20	4.4	6	150	1	0.856	0.771	0.343	0.128	0.116	0.051
TPSC226*020#0400	C	22	20	4.4	6	400	1	0.524	0.472	0.210	0.210	0.189	0.084
TPSD226*020#0200	D	22	20	4.4	6	200	1	0.866	0.779	0.346	0.173	0.156	0.069
TPSD226*020#0300	D	22	20	4.4	6	300	1	0.707	0.636	0.283	0.212	0.191	0.085
TPSC336*020#0300	C	33	20	6.6	6	300	1	0.606	0.545	0.242	0.182	0.163	0.073
TPSD336*020#0100	D	33	20	6.6	6	100	1	1.225	1.102	0.490	0.122	0.110	0.049
TPSD336*020#0200	D	33	20	6.6	6	200	1	0.866	0.779	0.346	0.173	0.155	0.069
TPSD476*020#0075	D	47	20	9.4	6	75	1	1.414	1.273	0.566	0.106	0.095	0.042
TPSD476*020#0100	D	47	20	9.4	6	100	1	1.225	1.102	0.490	0.122	0.110	0.049
TPSD476*020#0200	D	47	20	9.4	6	200	1	0.866	0.779	0.346	0.173	0.156	0.069
TPSE476*020#0070	E	47	20	9.4	6	70	1 ¹⁾	1.535	1.382	0.614	0.107	0.097	0.043
TPSE476*020#0125	E	47	20	9.4	6	125	1 ¹⁾	1.149	1.034	0.460	0.144	0.129	0.057
TPSE476*020#0150	E	47	20	9.4	6	150	1 ¹⁾	1.049	0.944	0.420	0.157	0.142	0.063
TPSE476*020#0200	E	47	20	9.4	6	200	1 ¹⁾	0.908	0.817	0.363	0.182	0.163	0.073
TPSE476*020#0250	E	47	20	9.4	6	250	1 ¹⁾	0.812	0.731	0.325	0.203	0.183	0.081
TPSX476*020#0200	X	47	20	9.4	6	200	1 ¹⁾	0.707	0.636	0.283	0.141	0.127	0.057
TPSD686*020#0070	D	68	20	13.6	6	70	1	1.464	1.317	0.586	0.102	0.092	0.041
TPSD686*020#0150	D	68	20	13.6	6	150	1	1.000	0.900	0.400	0.150	0.135	0.060
TPSD686*020#0200	D	68	20	13.6	6	200	1	0.866	0.779	0.346	0.173	0.156	0.069
TPSD686*020#0300	D	68	20	13.6	6	300	1	0.707	0.636	0.283	0.212	0.191	0.085
TPSE686*020#0125	E	68	20	13.6	6	125	1 ¹⁾	1.149	1.034	0.460	0.144	0.129	0.057
TPSE686*020#0150	E	68	20	13.6	6	150	1 ¹⁾	1.049	0.944	0.420	0.157	0.142	0.063
TPSE686*020#0200	E	68	20	13.6	6	200	1 ¹⁾	0.908	0.817	0.363	0.182	0.163	0.073
TPSY686*020#0200	Y	68	20	13.6	6	200	1 ¹⁾	0.791	0.712	0.316	0.158	0.142	0.063
TPSD107*020#0085	D	100	20	20	6	85	1	1.328	1.196	0.531	0.113	0.102	0.045
TPSD107*020#0100	D	100	20	20	6	100	1	1.225	1.102	0.490	0.122	0.110	0.049
TPSD107*020#0150	D	100	20	20	6	150	1	1.000	0.900	0.400	0.150	0.135	0.060
TPSE107*020#0100	E	100	20	20	6	100	1 ¹⁾	1.285	1.156	0.514	0.128	0.116	0.051
TPSE107*020#0150	E	100	20	20	6	150	1 ¹⁾	1.049	0.944	0.420	0.157	0.142	0.063
TPSE107*020#0200	E	100	20	20	6	200	1 ¹⁾	0.908	0.817	0.363	0.182	0.163	0.073
TPSV107*020#0060	V	100	20	20	8	60	1 ¹⁾	2.041	1.837	0.816	0.122	0.110	0.049
TPSV107*020#0085	V	100	20	20	8	85	1 ¹⁾	1.715	1.543	0.686	0.146	0.131	0.058
TPSV107*020#0100	V	100	20	20	8	100	1 ¹⁾	1.581	1.423	0.632	0.158	0.142	0.063
TPSV107*020#0200	V	100	20	20	8	200	1 ¹⁾	1.118	1.006	0.447	0.224	0.201	0.089
TPSV157*020#0080	V	150	20	30	8	80	1 ¹⁾	1.768	1.591	0.707	0.141	0.127	0.057
25 Volt @ 85°C (17 Volt @ 125°C)													
TPSA474*025#7000	A	0.47	25	0.5	4	7000	1	0.104	0.093	0.041	0.725	0.652	0.290
TPSA684*025#6000	A	0.68	25	0.5	4	6000	1	0.112	0.101	0.045	0.671	0.604	0.268
TPSA105*025#4000	A	1	25	0.5	4	4000	1	0.137	0.123	0.055	0.548	0.493	0.219
TPSR105*025#2500	R	1	25	0.5	4	2500	1	0.148	0.133	0.059	0.371	0.334	0.148
TPSR105*025#4000	R	1	25	0.5	4	4000	1	0.117	0.106	0.047	0.469	0.422	0.188
TPSA155*025#3000	A	1.5	25	0.5	6	3000	1	0.158	0.142	0.063	0.474	0.427	0.190
TPSB155*025#1800	B	1.5	25	0.5	6	1800	1	0.217	0.196	0.087	0.391	0.352	0.156
TPSA225*025#2500	A	2.2	25	0.6	6	2500	1	0.173	0.156	0.069	0.433	0.390	0.173
TPSB225*025#0900	B	2.2	25	0.6	6	900	1	0.307	0.277	0.123	0.277	0.249	0.111
TPSB225*025#1200	B	2.2	25	0.6	6	1200	1	0.266	0.240	0.106	0.319	0.287	0.128
TPSB225*025#2500	B	2.2	25	0.6	6	2500	1	0.184	0.166	0.074	0.461	0.415	0.184
TPSA335*025#1000	A	3.3	25	0.8	6	1000	1	0.274	0.246	0.110	0.274	0.246	0.110
TPSA335*025#1500	A	3.3	25	0.8	6	1500	1	0.224	0.201	0.089	0.335	0.302	0.134
TPSB335*025#0750	B	3.3	25	0.8	6	750	1	0.337	0.303	0.135	0.252	0.227	0.101
TPSB335*025#1500	B	3.3	25	0.8	6	1500	1	0.238	0.214	0.095	0.357	0.321	0.143
TPSB335*025#2000	B	3.3	25	0.8	6	2000	1	0.206	0.186	0.082	0.412	0.371	0.165
TPSB475*025#0700	B	4.7	25	1.2	6	700	1	0.348	0.314	0.139	0.244	0.220	0.098
TPSB475*025#0900	B	4.7	25	1.2	6	900	1	0.307	0.277	0.123	0.277	0.249	0.111
TPSB475*025#1500	B	4.7	25	1.2	6	1500	1	0.238	0.214	0.095	0.357	0.321	0.143
TPSC475*025#0700	C	4.7	25	1.2	6	700	1	0.396	0.357	0.159	0.277	0.250	0.111
TPSB685*025#0700	B	6.8	25	1.7	6	700	1	0.348	0.314	0.139	0.244	0.220	0.098
TPSC685*025#0500	C	6.8	25	1.7	6	500	1	0.469	0.422	0.188	0.235	0.211	0.094
TPSC685*025#0600	C	6.8	25	1.7	6	600	1	0.428	0.385	0.171	0.257	0.231	0.103

¹⁾ Dry pack option (see How to order) recommended for reduction of stress during soldering. Dry pack parts should be treated as MSL 3.

Moisture Sensitivity Level (MSL) is defined according to J-STD-020.

For AEC-Q200 availability, please contact AVX.

All technical data relates to an ambient temperature of +25°C. Capacitance and DF are measured at 120Hz, 0.5V RMS with a maximum DC bias of 2.2 volts.

DCL is measured at rated voltage after 5 minutes.

The EIA & CECC standards for low ESR Solid Tantalum Capacitors allow an ESR movement to 1.25 times catalogue limit post mounting.

For typical weight and composition see page 144.

NOTE: AVX reserves the right to supply a higher voltage rating or tighter tolerance part in the same case size, to the same reliability standards.

RATINGS & PART NUMBER REFERENCE

AVX Part No.	Case Size	Capacitance (µF)	Rated Voltage (V)	DCL (µA) Max.	DF % Max.	ESR Max. (mΩ) @100kHz	MSL	100kHz RMS Current (A)			100kHz RMS Voltage (V)		
								25°C	85°C	125°C	25°C	85°C	125°C
TPSC685*025#0700	C	6.8	25	1.7	6	700	1	0.396	0.357	0.159	0.277	0.250	0.111
TPSB106*025#1800	B	10	25	2.5	6	1800	1	0.217	0.196	0.087	0.391	0.352	0.156
TPSC106*025#0300	C	10	25	2.5	6	300	1	0.606	0.545	0.242	0.182	0.163	0.073
TPSC106*025#0500	C	10	25	2.5	6	500	1	0.469	0.422	0.188	0.235	0.211	0.094
TPSD106*025#0500	D	10	25	2.5	6	500	1	0.548	0.493	0.219	0.274	0.246	0.110
TPSC156*025#0220	C	15	25	3.8	6	220	1	0.707	0.636	0.283	0.156	0.140	0.062
TPSC156*025#0300	C	15	25	3.8	6	300	1	0.606	0.545	0.242	0.182	0.163	0.073
TPSD156*025#0100	D	15	25	3.8	6	100	1	1.225	1.102	0.490	0.122	0.110	0.049
TPSD156*025#0300	D	15	25	3.8	6	300	1	0.707	0.636	0.283	0.212	0.191	0.085
TPSC226*025#0275	C	22	25	5.5	6	275	1	0.632	0.569	0.253	0.174	0.157	0.070
TPSC226*025#0400	C	22	25	5.5	6	400	1	0.524	0.472	0.210	0.210	0.189	0.084
TPSD226*025#0100	D	22	25	5.5	6	100	1	1.225	1.102	0.490	0.122	0.110	0.049
TPSD226*025#0200	D	22	25	5.5	6	200	1	0.866	0.779	0.346	0.173	0.156	0.069
TPSD226*025#0300	D	22	25	5.5	6	300	1	0.707	0.636	0.283	0.212	0.191	0.085
TPSD336*025#0100	D	33	25	8.3	6	100	1	1.225	1.102	0.490	0.122	0.110	0.049
TPSD336*025#0200	D	33	25	8.3	6	200	1	0.866	0.779	0.346	0.173	0.156	0.069
TPSD336*025#0300	D	33	25	8.3	6	300	1	0.707	0.636	0.283	0.212	0.191	0.085
TPSE336*025#0100	E	33	25	8.3	6	100	1 ¹⁾	1.285	1.156	0.514	0.128	0.116	0.051
TPSE336*025#0175	E	33	25	8.3	6	175	1 ¹⁾	0.971	0.874	0.388	0.170	0.153	0.068
TPSE336*025#0200	E	33	25	8.3	6	200	1 ¹⁾	0.908	0.817	0.363	0.182	0.163	0.073
TPSE336*025#0300	E	33	25	8.3	6	300	1 ¹⁾	0.742	0.667	0.297	0.222	0.200	0.089
TPSY336*025#0200	Y	33	25	8.3	6	200	1 ¹⁾	0.791	0.712	0.316	0.158	0.142	0.063
TPSD476*025#0125	D	47	25	11.8	6	125	1	1.095	0.986	0.438	0.137	0.123	0.055
TPSD476*025#0150	D	47	25	11.8	6	150	1	1.000	0.900	0.400	0.150	0.135	0.060
TPSD476*025#0250	D	47	25	11.8	6	250	1	0.775	0.697	0.310	0.194	0.174	0.077
TPSE476*025#0080	E	47	25	11.8	6	80	1 ¹⁾	1.436	1.293	0.574	0.115	0.103	0.046
TPSE476*025#0100	E	47	25	11.8	6	100	1 ¹⁾	1.285	1.156	0.514	0.128	0.116	0.051
TPSE476*025#0125	E	47	25	11.8	6	125	1 ¹⁾	1.149	1.034	0.460	0.144	0.129	0.057
TPSE476*025#0250	Y	47	25	11.8	6	250	1 ¹⁾	0.707	0.636	0.283	0.177	0.159	0.071
TPSE686*025#0125	E	68	25	17	6	125	1 ¹⁾	1.149	1.034	0.460	0.144	0.129	0.057
TPSE686*025#0200	E	68	25	17	6	200	1 ¹⁾	0.908	0.817	0.363	0.182	0.163	0.073
TPSV686*025#0080	V	68	25	17	6	80	1 ¹⁾	1.768	1.591	0.707	0.141	0.127	0.057
TPSV686*025#0095	V	68	25	17	6	95	1 ¹⁾	1.622	1.460	0.649	0.154	0.139	0.062
TPSV686*025#0150	V	68	25	17	6	150	1 ¹⁾	1.291	1.162	0.516	0.194	0.174	0.077
TPSV686*025#0200	V	68	25	17	6	200	1 ¹⁾	1.118	1.006	0.447	0.224	0.201	0.089
TPSE107M025#0150	E	100	25	25	10	150	1 ¹⁾	1.049	0.944	0.420	0.157	0.142	0.063
TPSV107*025#0100	V	100	25	25	8	100	1 ¹⁾	1.581	1.423	0.632	0.158	0.142	0.063
TPSV157M025#0150	V	150	25	37.5	10	150	1 ¹⁾	1.291	1.162	0.516	0.194	0.174	0.077
35 Volt @ 85°C (23 Volt @ 125°C)													
TPSA224*035#6000	A	0.22	35	0.5	4	6000	1	0.112	0.101	0.045	0.671	0.604	0.268
TPSA334*035#6000	A	0.33	35	0.5	4	6000	1	0.112	0.101	0.045	0.671	0.604	0.268
TPSA474*035#6000	A	0.47	35	0.5	4	6000	1	0.112	0.101	0.045	0.671	0.604	0.268
TPSB474*035#4000	B	0.47	35	0.5	4	4000	1	0.146	0.131	0.058	0.583	0.525	0.233
TPSA684*035#6000	A	0.68	35	0.5	4	6000	1	0.112	0.101	0.045	0.671	0.604	0.268
TPSA105*035#3000	A	1	35	0.5	4	3000	1	0.158	0.142	0.063	0.474	0.427	0.190
TPSB105*035#2000	B	1	35	0.5	4	2000	1	0.206	0.186	0.082	0.412	0.371	0.165
TPSA155*035#3000	A	1.5	35	0.5	6	3000	1	0.158	0.142	0.063	0.474	0.427	0.190
TPSB155*035#2500	B	1.5	35	0.5	6	2500	1	0.184	0.166	0.074	0.461	0.415	0.184
TPSA225*035#1500	A	2.2	35	0.8	6	1500	1	0.224	0.201	0.089	0.335	0.302	0.134
TPSB225*035#0750	B	2.2	35	0.8	6	750	1	0.337	0.303	0.135	0.252	0.227	0.101
TPSB225*035#1500	B	2.2	35	0.8	6	1500	1	0.238	0.214	0.095	0.357	0.321	0.143
TPSB225*035#2000	B	2.2	35	0.8	6	2000	1	0.206	0.186	0.082	0.412	0.371	0.165
TPSC225*035#1000	C	2.2	35	0.8	6	1000	1	0.332	0.298	0.133	0.332	0.298	0.133
TPSB335*035#1000	B	3.3	35	1.2	6	1000	1	0.292	0.262	0.117	0.292	0.262	0.117
TPSC335*035#0700	C	3.3	35	1.2	6	700	1	0.396	0.357	0.159	0.277	0.250	0.111
TPSB475*035#0700	B	4.7	35	1.6	6	700	1	0.348	0.314	0.139	0.244	0.220	0.098
TPSB475*035#1500	B	4.7	35	1.6	6	1500	1	0.238	0.214	0.095	0.357	0.321	0.143
TPSC475*035#0600	C	4.7	35	1.6	6	600	1	0.428	0.385	0.171	0.257	0.231	0.103
TPSD475*035#0700	D	4.7	35	1.6	6	700	1	0.463	0.417	0.185	0.324	0.292	0.130
TPSC685*035#0350	C	6.8	35	2.4	6	350	1	0.561	0.505	0.224	0.196	0.177	0.078
TPSD685*035#0150	D	6.8	35	2.4	6	150	1	1.000	0.900	0.400	0.150	0.135	0.060
TPSD685*035#0400	D	6.8	35	2.4	6	400	1	0.612	0.551	0.245	0.245	0.220	0.098
TPSD685*035#0500	D	6.8	35	2.4	6	500	1	0.548	0.493	0.219	0.274	0.246	0.110
TPSC106*035#0600	C	10	35	3.5	6	600	1	0.428	0.385	0.171	0.257	0.231	0.103
TPSD106*035#0125	D	10	35	3.5	6	125	1	1.095	0.986	0.438	0.137	0.123	0.055
TPSD106*035#0300	D	10	35	3.5	6	300	1	0.707	0.636	0.283	0.212	0.191	0.085
TPSE106*035#0200	E	10	35	3.5	6	200	1 ¹⁾	0.908	0.817	0.363	0.182	0.163	0.073

¹⁾ Dry pack option (see How to order) recommended for reduction of stress during soldering. Dry pack parts should be treated as MSL 3.

Moisture Sensitivity Level (MSL) is defined according to J-STD-020.

For AEC-Q200 availability, please contact AVX.

All technical data relates to an ambient temperature of +25°C. Capacitance and DF are measured at 120Hz, 0.5V RMS with a maximum DC bias of 2.2 volts. DCL is measured at rated voltage after 5 minutes.

The EIA & CECC standards for low ESR Solid Tantalum Capacitors allow an ESR movement to 1.25 times catalogue limit post mounting.

For typical weight and composition see page 144.

NOTE: AVX reserves the right to supply a higher voltage rating or tighter tolerance part in the same case size, to the same reliability standards.

RATINGS & PART NUMBER REFERENCE

AVX Part No.	Case Size	Capacitance (µF)	Rated Voltage (V)	DCL (µA) Max.	DF % Max.	ESR Max. (mΩ) @100kHz	MSL	100kHz RMS Current (A)			100kHz RMS Voltage (V)		
								25°C	85°C	125°C	25°C	85°C	125°C
TPSY106*035#0250	Y	10	35	3.5	6	250	1 ¹⁾	0.707	0.636	0.283	0.177	0.159	0.071
TPSC156*035#0350	C	15	35	5.3	6	350	1	0.561	0.505	0.224	0.196	0.177	0.078
TPSC156*035#0450	C	15	35	5.3	6	450	1	0.494	0.445	0.198	0.222	0.200	0.089
TPSD156*035#0100	D	15	35	5.3	6	100	1	1.225	1.102	0.490	0.122	0.110	0.049
TPSD156*035#0300	D	15	35	5.3	6	300	1	0.707	0.636	0.283	0.212	0.191	0.085
TPSY156*035#0250	Y	15	35	5.3	6	250	1 ¹⁾	0.707	0.636	0.283	0.177	0.159	0.071
TPSD226*035#0125	D	22	35	7.7	6	125	1	1.095	0.986	0.438	0.137	0.123	0.055
TPSD226*035#0200	D	22	35	7.7	6	200	1	0.866	0.779	0.346	0.173	0.156	0.069
TPSD226*035#0300	D	22	35	7.7	6	300	1	0.707	0.636	0.283	0.212	0.191	0.085
TPSD226*035#0400	D	22	35	7.7	6	400	1	0.612	0.551	0.245	0.245	0.220	0.098
TPSE226*035#0125	E	22	35	7.7	6	125	1 ¹⁾	1.149	1.034	0.460	0.144	0.129	0.057
TPSE226*035#0200	E	22	35	7.7	6	200	1 ¹⁾	0.908	0.817	0.363	0.182	0.163	0.073
TPSE226*035#0300	E	22	35	7.7	6	300	1 ¹⁾	0.742	0.667	0.297	0.222	0.200	0.089
TPSY226*035#0200	Y	22	35	7.7	6	200	1 ¹⁾	0.791	0.712	0.316	0.158	0.142	0.063
TPSD336*035#0200	D	33	35	11.6	6	200	1	0.866	0.779	0.346	0.173	0.156	0.069
TPSD336*035#0300	D	33	35	11.6	6	300	1	0.707	0.636	0.283	0.212	0.191	0.085
TPSE336*035#0100	E	33	35	11.6	6	100	1 ¹⁾	1.285	1.156	0.514	0.128	0.116	0.051
TPSE336*035#0250	E	33	35	11.6	6	250	1 ¹⁾	0.812	0.731	0.325	0.203	0.183	0.081
TPSE336*035#0300	E	33	35	11.6	6	300	1 ¹⁾	0.742	0.667	0.297	0.222	0.200	0.089
TPSV336*035#0200	V	33	35	11.6	6	200	1 ¹⁾	1.118	1.006	0.447	0.224	0.201	0.089
TPSE476*035#0200	E	47	35	16.5	6	200	1 ¹⁾	0.908	0.817	0.363	0.182	0.163	0.073
TPSE476*035#0250	E	47	35	16.5	6	250	1 ¹⁾	0.812	0.731	0.325	0.203	0.183	0.081
TPSV476*035#0150	V	47	35	16.5	6	150	1 ¹⁾	1.291	1.162	0.516	0.194	0.174	0.077
TPSV476*035#0200	V	47	35	16.5	6	200	1 ¹⁾	1.118	1.006	0.447	0.224	0.201	0.089
TPSV686*035#0150	V	68	35	23.8	6	150	1 ¹⁾	1.291	1.162	0.516	0.194	0.174	0.077
TPSV686*035#0200	V	68	35	23.8	6	200	1 ¹⁾	1.118	1.006	0.447	0.224	0.201	0.089
50 Volt @ 85°C (33 Volt @ 125°C)													
TPSA154*050#9000	A	0.15	50	0.5	4	9000	1	0.091	0.082	0.037	0.822	0.739	0.329
TPSA224*050#7000	A	0.22	50	0.5	4	7000	1	0.104	0.093	0.041	0.725	0.652	0.290
TPSA334*050#7000	A	0.33	50	0.5	4	7000	1	0.104	0.093	0.041	0.725	0.652	0.290
TPSA474*050#6500	A	0.47	50	0.5	4	6500	1	0.107	0.097	0.043	0.698	0.628	0.279
TPSB474*050#6000	B	0.47	50	0.5	4	6000	1	0.119	0.107	0.048	0.714	0.643	0.286
TPSC474*050#2300	C	0.47	50	0.5	4	2300	1	0.219	0.197	0.087	0.503	0.453	0.201
TPSB684*050#4000	B	0.68	50	0.5	4	4000	1	0.146	0.131	0.058	0.583	0.525	0.233
TPSB105*050#3000	B	1	50	0.5	6	3000	1	0.168	0.151	0.067	0.505	0.454	0.202
TPSC105*050#2500	C	1	50	0.5	4	2500	1	0.210	0.189	0.084	0.524	0.472	0.210
TPSC155*050#1500	C	1.5	50	0.8	6	1500	1	0.271	0.244	0.108	0.406	0.366	0.162
TPSC155*050#2000	C	1.5	50	0.8	6	2000	1	0.235	0.211	0.094	0.469	0.422	0.188
TPSC225*050#1500	C	2.2	50	1.1	8	1500	1	0.271	0.244	0.108	0.406	0.366	0.162
TPSD225*050#1200	D	2.2	50	1.1	6	1200	1	0.354	0.318	0.141	0.424	0.382	0.170
TPSC335*050#1000	C	3.3	50	1.6	6	1000	1	0.332	0.298	0.133	0.332	0.298	0.133
TPSD335*050#0800	D	3.3	50	1.7	6	800	1	0.433	0.390	0.173	0.346	0.312	0.139
TPSC475*050#0800	C	4.7	50	2.4	6	800	1	0.371	0.334	0.148	0.297	0.267	0.119
TPSD475*050#0300	D	4.7	50	2.4	6	300	1	0.707	0.636	0.283	0.212	0.191	0.085
TPSD475*050#0500	D	4.7	50	2.4	6	500	1	0.548	0.493	0.219	0.274	0.246	0.110
TPSD475*050#0700	D	4.7	50	2.4	6	700	1	0.463	0.417	0.185	0.324	0.292	0.130
TPSD685*050#0200	D	6.8	50	3.4	6	200	1	0.866	0.779	0.346	0.173	0.156	0.069
TPSD685*050#0300	D	6.8	50	3.4	6	300	1	0.707	0.636	0.283	0.212	0.191	0.085
TPSD685*050#0500	D	6.8	50	3.4	6	500	1	0.548	0.493	0.219	0.274	0.246	0.110
TPSD685*050#0600	D	6.8	50	3.4	6	600	1	0.500	0.450	0.200	0.300	0.270	0.120
TPSD106*050#0500	D	10	50	5	6	500	1	0.548	0.493	0.219	0.274	0.246	0.110
TPSE106*050#0250	E	10	50	5	6	250	1 ¹⁾	0.812	0.731	0.325	0.203	0.183	0.081
TPSE106*050#0300	E	10	50	5	6	300	1 ¹⁾	0.742	0.667	0.297	0.222	0.200	0.089
TPSE106*050#0400	E	10	50	5	6	400	1 ¹⁾	0.642	0.578	0.257	0.257	0.231	0.103
TPSE106*050#0500	E	10	50	5	6	500	1 ¹⁾	0.574	0.517	0.230	0.287	0.259	0.115
TPSE156*050#0250	E	15	50	7.5	6	250	1 ¹⁾	0.812	0.731	0.325	0.203	0.183	0.081
TPSV156*050#0250	V	15	50	7.5	6	250	1 ¹⁾	1.000	0.900	0.400	0.250	0.225	0.100

¹⁾ Dry pack option (see How to order) recommended for reduction of stress during soldering. Dry pack parts should be treated as MSL 3.

Moisture Sensitivity Level (MSL) is defined according to J-STD-020.

For AEC-Q200 availability, please contact AVX.

All technical data relates to an ambient temperature of +25°C. Capacitance and DF are measured at 120Hz, 0.5V RMS with a maximum DC bias of 2.2 volts.

DCL is measured at rated voltage after 5 minutes.

The EIA & CECC standards for low ESR Solid Tantalum Capacitors allow an ESR movement to 1.25 times catalogue limit post mounting.

For typical weight and composition see page 144.

NOTE: AVX reserves the right to supply a higher voltage rating or tighter tolerance part in the same case size, to the same reliability standards.

TPS Automotive Range



Low ESR - Automotive Product Range

TPS AUTOMOTIVE RANGE CAPACITANCE AND RATED VOLTAGE, V_R (VOLTAGE CODE) RANGE (LETTER DENOTES CASE SIZE)

Capacitance		Rated Voltage DC (V_R) to 85°C						
μF	Code	6.3V (J)	10V (A)	16V (C)	20V (D)	25V (E)	35V (V)	50V (T)
0.15	154							
0.22	224							A(7000)
0.33	334						A(6000)	A(7000)
0.47	474					A(7000)	A(6000)	A(6500), B(6000)
0.68	684					A(6000)	A(6000)	B(4000)
1.0	105			A(6200)	A(3000)	A(4000)	A(3000), B(2000)	B(3000), C(2500)
1.5	155				A(3000)	A(3000)	A(3000), B(2500)	C(1500,2000)
2.2	225		A(1800)	A(1800,3500)	A(3000), B(1700)	A(2500), B(900,1200,2500)	B(750,1500,2000), C(1000)	C(1500), D(1200)
3.3	335	A(2100)		A(3500), B(2500)	A(2500), B(1300)	B(750,1500,2000)	B(1000), C(700)	C(1000), D(800)
4.7	475		A(1400), B(1400)	A(2000), B(800,1500)	A(1800), B(750,1000)	B(700,900), C(700)	B(700,1500), C(600), D(700)	C(800), D(500,700)
6.8	685		A(1800), B(1300)	A(1500), B(600,1200)	B(600,1000), C(700)	B(700), C(500,600,700)	C(350), D(400,500)	D(500,600)
10	106	A(1500), B(1500)	A(900,1800), B(1000)	A(1000), B(500,800), C(500)	B(500,1000), C(500,700)	C(300,500), D(500)	C(600), D(300)	D(500), E(250,300,400,500)
15	156	A(700,1500)	A(1000), B(450,600), C(700)	B(500,800), C(700)	B(500), C(400,450)	C(220,300), D(300)	D(300)	E(250)
22	226	A(500,900), B(375,600), C(500)	A(900), B(400,500,700), C(300)	B(400,600), C(300,375), D(700)	C(400), D(200,300)	C(275,400), D(200,300)	D(200,300,400), E(200,300)	
33	336	A(600), B(250,350,450,600)	B(250,425,500,650), C(375,500)	C(225,300), D(200)	C(300), D(200)	D(200,300)	E(250,300)	
47	476	B(250,350,500), C(300)	B(250,350,500,650), C(200,350), D(300)	C(350), D(200)	D(200)	D(125,150,250), E(125)		
68	686	B(250,350,500), C(150,200)	C(200,300), D(150)	C(200), D(150)	D(150,200,300), E(125,150,200)			
100	107	C(150), D(300)	C(150,200), D(100,125,150)	D(100,125,150), E(100,125,150)	E(100,150,200)			
150	157	C(150,200,250), D(125)	D(85,100), E(100)	E(100)				
220	227	D(100,125)	D(100,150), E(70,100,125,150)					
330	337	D(70,100), E(100,125,150)	E(50,60,100)					
470	477	D(45,60,100,200), E(45,50,60,100,200)						
680	687	E(45,60,100)						

Not recommended for new designs, higher voltage or smaller case size substitution are offered.

Released codes

Engineering samples - please contact manufacturer

Note: Voltage ratings are minimum values. AVX reserves the right to supply higher ratings in the same case size, to the same reliability standards.

HOW TO ORDER

TPS	C	107	M	010	T	0150	V
Type	Case Size	Capacitance Code	Tolerance	Rated DC Voltage	Packaging	ESR in m Ω	Dry Pack Option
	See table above	pF code: 1st two digits represent significant figures, 3rd digit represents multiplier (number of zeros to follow)	K = $\pm 10\%$ M = $\pm 20\%$	006 = 6.3Vdc 010 = 10Vdc 016 = 16Vdc 020 = 20Vdc 025 = 25Vdc 035 = 35Vdc 050 = 50Vdc	T = Automotive Lead Free 7" Reel U = Automotive Lead Free 13" Reel		(D,E case sizes mandatory)

TECHNICAL SPECIFICATIONS

Technical Data:

All technical data relate to an ambient temperature of +25°C

Capacitance Range:	0.22 μF to 680 μF								
Capacitance Tolerance:	$\pm 10\%$; $\pm 20\%$								
Rated Voltage (V_R)	$\leq +85^\circ\text{C}$:	6.3	10	16	20	25	35	50	
Category Voltage (V_C)	$\leq +125^\circ\text{C}$:	4	7	10	13	17	23	33	
Surge Voltage (V_S)	$\leq +85^\circ\text{C}$:	8	13	20	26	32	46	65	
Surge Voltage (V_S)	$\leq +125^\circ\text{C}$:	5	8	13	16	20	28	40	
Temperature Range:	-55°C to +125°C								
Environmental Classification:	55/125/56 (IEC 68-2)								
Reliability:	1% per 1000 hours at 85°C, V_R with 0.1 Ω /V series impedance, 60% confidence level								
Termination Finished:	Sn Plating (standard), Gold and SnPb Plating upon request								
	Meets requirements of AEC-Q200								



TPS Automotive Range

Low ESR - Automotive Product Range



RATINGS & PART NUMBER REFERENCE

AVX Part No.*	Case Size	Capacitance (µF)	Rated Voltage (V)	DCL (µA) Max.	DF % Max.	ESR Max. (mΩ) @100kHz	MSL	100kHz RMS Current (A)			100kHz RMS Voltage (V)		
								25°C	85°C	125°C	25°C	85°C	125°C
6.3 Volt @ 85°C (4 Volt @ 125°C)													
TPSA335*006T2100	A	3.3	6.3	0.5	6	2100	1	0.189	0.170	0.076	0.397	0.357	0.159
TPSA106*006T1500	A	10	6.3	0.6	6	1500	1	0.224	0.201	0.089	0.335	0.302	0.134
TPSB106*006T1500	B	10	6.3	0.6	6	1500	1	0.238	0.214	0.095	0.357	0.321	0.143
TPSA156*006T0700	A	15	6.3	0.9	6	700	1	0.327	0.295	0.131	0.229	0.206	0.092
TPSA156*006T1500	A	15	6.3	0.9	6	1500	1	0.224	0.201	0.089	0.335	0.302	0.134
TPSA226*006T0500	A	22	6.3	1.4	6	500	1	0.387	0.349	0.155	0.194	0.174	0.077
TPSA226*006T0900	A	22	6.3	1.4	6	900	1	0.289	0.260	0.115	0.260	0.234	0.104
TPSB226*006T0375	B	22	6.3	1.4	6	375	1	0.476	0.428	0.190	0.179	0.161	0.071
TPSB226*006T0600	B	22	6.3	1.4	6	600	1	0.376	0.339	0.151	0.226	0.203	0.090
TPSC226*006T0500	C	22	6.3	1.4	6	500	1	0.469	0.422	0.188	0.235	0.211	0.094
TPSA336*006T0600	A	33	6.3	2.1	8	600	1	0.354	0.318	0.141	0.212	0.191	0.085
TPSB336*006T0250	B	33	6.3	2.1	6	250	1	0.583	0.525	0.233	0.146	0.131	0.058
TPSB336*006T0350	B	33	6.3	2.1	6	350	1	0.493	0.444	0.197	0.172	0.155	0.069
TPSB336*006T0450	B	33	6.3	2.1	6	450	1	0.435	0.391	0.174	0.196	0.176	0.078
TPSB336*006T0600	B	33	6.3	2.1	6	600	1	0.376	0.339	0.151	0.226	0.203	0.090
TPSB476*006T0250	B	47	6.3	3	6	250	1	0.583	0.525	0.233	0.146	0.131	0.058
TPSB476*006T0350	B	47	6.3	3	6	350	1	0.493	0.444	0.197	0.172	0.155	0.069
TPSB476*006T0500	B	47	6.3	3	6	500	1	0.412	0.371	0.165	0.206	0.186	0.082
TPSC476*006T0300	C	47	6.3	3	6	300	1	0.606	0.545	0.242	0.182	0.163	0.073
TPSB686*006T0250	B	68	6.3	4	8	250	1	0.583	0.525	0.233	0.146	0.131	0.058
TPSB686*006T0350	B	68	6.3	4	8	350	1	0.493	0.444	0.197	0.172	0.155	0.069
TPSB686*006T0500	B	68	6.3	4	8	500	1	0.412	0.371	0.165	0.206	0.186	0.082
TPSC686*006T0150	C	68	6.3	4.3	6	150	1	0.856	0.771	0.343	0.128	0.116	0.051
TPSC686*006T0200	C	68	6.3	4.3	6	200	1	0.742	0.667	0.297	0.148	0.133	0.059
TPSC107*006T0150	C	100	6.3	6.3	6	150	1	0.856	0.771	0.343	0.128	0.116	0.051
TPSD107*006T0300V	D	100	6.3	6.3	6	300	3	0.707	0.636	0.283	0.121	0.119	0.085
TPSC157*006T0150	C	150	6.3	9.5	6	150	1	0.856	0.771	0.343	0.128	0.116	0.051
TPSC157*006T0200	C	150	6.3	9.5	6	200	1	0.742	0.667	0.297	0.148	0.133	0.059
TPSC157*006T0250	C	150	6.3	9.5	6	250	1	0.663	0.597	0.265	0.166	0.149	0.066
TPSD157*006T0125V	D	150	6.3	9.5	6	125	3	1.095	0.986	0.438	0.137	0.123	0.055
TPSD227*006T0100V	D	220	6.3	13.9	8	100	3	1.225	1.102	0.490	0.122	0.110	0.049
TPSD227*006T0125V	D	220	6.3	13.9	8	125	3	1.095	0.986	0.438	0.137	0.123	0.055
TPSD337*006T0070V	D	330	6.3	20.8	8	70	3	1.464	1.317	0.586	0.102	0.092	0.041
TPSD337*006T0100V	D	330	6.3	20.8	8	100	3	1.225	1.102	0.490	0.122	0.110	0.049
TPSE337*006T0100V	E	330	6.3	20.8	8	100	3	1.285	1.156	0.514	0.128	0.116	0.051
TPSE337*006T0125V	E	330	6.3	20.8	8	125	3	1.149	1.034	0.460	0.144	0.129	0.057
TPSE337*006T0150V	E	330	6.3	20.8	8	150	3	1.049	0.944	0.420	0.157	0.142	0.063
TPSD477*006T0045V	D	470	6.3	28	12	45	3	1.826	1.643	0.730	0.082	0.074	0.033
TPSD477*006T0060V	D	470	6.3	28	12	60	3	1.581	1.423	0.632	0.095	0.085	0.038
TPSD477*006T0100V	D	470	6.3	28	12	100	3	1.225	1.102	0.490	0.122	0.110	0.049
TPSD477*006T0200V	D	470	6.3	28	12	200	3	0.866	0.779	0.346	0.173	0.156	0.069
TPSE477*006T0045V	E	470	6.3	28	10	45	3	1.915	1.723	0.766	0.086	0.078	0.034
TPSE477*006T0050V	E	470	6.3	28	10	50	3	1.817	1.635	0.727	0.091	0.082	0.036
TPSE477*006T0060V	E	470	6.3	28	10	60	3	1.658	1.492	0.663	0.099	0.090	0.040
TPSE477*006T0100V	E	470	6.3	28	10	100	3	1.285	1.156	0.514	0.128	0.116	0.051
TPSE477*006T0200V	E	470	6.3	28	10	200	3	0.908	0.817	0.363	0.182	0.163	0.073
TPSE687*006T0045V	E	680	6.3	42.8	10	45	3	1.915	1.723	0.766	0.086	0.078	0.034
TPSE687*006T0060V	E	680	6.3	42.8	10	60	3	1.658	1.492	0.663	0.099	0.090	0.040
TPSE687*006T0100V	E	680	6.3	42.8	10	100	3	1.285	1.156	0.514	0.128	0.116	0.051
10 Volt @ 85°C (7 Volt @ 125°C)													
TPSA225*010T1800	A	2.2	10	0.5	6	1800	1	0.204	0.184	0.082	0.367	0.331	0.147
TPSA475*010T1400	A	4.7	10	0.5	6	1400	1	0.231	0.208	0.093	0.324	0.292	0.130
TPSB475*010T1400	B	4.7	10	0.5	6	1400	1	0.246	0.222	0.099	0.345	0.310	0.138
TPSA685*010T1800	A	6.8	10	0.7	6	1800	1	0.204	0.184	0.082	0.367	0.331	0.147
TPSB685*010T1300	B	6.8	10	0.7	6	1300	1	0.256	0.230	0.102	0.332	0.299	0.133
TPSA106*010T0900	A	10	10	1	6	900	1	0.289	0.260	0.115	0.260	0.234	0.104
TPSA106*010T1800	A	10	10	1	6	1800	1	0.204	0.184	0.082	0.367	0.331	0.147
TPSB106*010T1000	B	10	10	1	6	1000	1	0.292	0.262	0.117	0.292	0.262	0.117
TPSA156*010T1000	A	15	10	1.5	6	1000	1	0.274	0.246	0.110	0.274	0.246	0.110
TPSB156*010T0450	B	15	10	1.5	6	450	1	0.435	0.391	0.174	0.196	0.176	0.078
TPSB156*010T0600	B	15	10	1.5	6	600	1	0.376	0.339	0.151	0.226	0.203	0.090
TPSC156*010T0700	C	15	10	1.5	6	700	1	0.396	0.357	0.159	0.277	0.250	0.111
TPSA226*010T0900	A	22	10	2.2	8	900	1	0.289	0.260	0.115	0.260	0.234	0.104
TPSB226*010T0400	B	22	10	2.2	6	400	1	0.461	0.415	0.184	0.184	0.166	0.074
TPSB226*010T0500	B	22	10	2.2	6	500	1	0.412	0.371	0.165	0.206	0.186	0.082
TPSB226*010T0700	B	22	10	2.2	6	700	1	0.348	0.314	0.139	0.244	0.220	0.098

Moisture Sensitivity Level (MSL) is defined according to J-STD-020

*Please use "U" instead of "T" in the suffix letter for 13" reel packaging

Please use specific PN for automotive version – see "HOW TO ORDER".

All technical data relates to an ambient temperature of +25°C. Capacitance and DF are measured at 120Hz, 0.5V RMS with a maximum DC bias of 2.2 volts. DCL is measured at rated voltage after 5 minutes.

The EIA & CECC standards for low ESR Solid Tantalum Capacitors allow an ESR movement to 1.25 times catalogue limit post mounting.

For typical weight and composition see page 144.

NOTE: AVX reserves the right to supply a higher voltage rating or tighter tolerance part in the same case size, to the same reliability standards.



TPS Automotive Range

Low ESR - Automotive Product Range



RATINGS & PART NUMBER REFERENCE

AVX Part No.*	Case Size	Capacitance (µF)	Rated Voltage (V)	DCL (µA) Max.	DF % Max.	ESR Max. (mΩ) @100kHz	MSL	100kHz RMS Current (A)			100kHz RMS Voltage (V)		
								25°C	85°C	125°C	25°C	85°C	125°C
TPSC226*010T0300	C	22	10	2.2	6	300	1	0.606	0.545	0.242	0.182	0.163	0.073
TPSB336*010T0250	B	33	10	3.3	6	250	1	0.583	0.525	0.233	0.146	0.131	0.058
TPSB336*010T0425	B	33	10	3.3	6	425	1	0.447	0.402	0.179	0.190	0.171	0.076
TPSB336*010T0500	B	33	10	3.3	6	500	1	0.412	0.371	0.165	0.206	0.186	0.082
TPSB336*010T0650	B	33	10	3.3	6	650	1	0.362	0.325	0.145	0.235	0.212	0.094
TPSC336*010T0375	C	33	10	3.3	6	375	1	0.542	0.487	0.217	0.203	0.183	0.081
TPSC336*010T0500	C	33	10	3.3	6	500	1	0.469	0.422	0.188	0.235	0.211	0.094
TPSB476*010T0250	B	47	10	4.7	8	250	1	0.583	0.525	0.233	0.146	0.131	0.058
TPSB476*010T0350	B	47	10	4.7	8	350	1	0.493	0.444	0.197	0.172	0.155	0.069
TPSB476*010T0500	B	47	10	4.7	8	500	1	0.412	0.371	0.165	0.206	0.186	0.082
TPSB476*010T0650	B	47	10	4.7	8	650	1	0.362	0.325	0.145	0.235	0.212	0.094
TPSC476*010T0200	C	47	10	4.7	6	200	1	0.742	0.667	0.297	0.148	0.133	0.059
TPSC476*010T0350	C	47	10	4.7	6	350	1	0.561	0.505	0.224	0.196	0.177	0.078
TPSD476*010T0300V	D	47	10	4.7	6	300	3	0.707	0.636	0.283	0.212	0.191	0.085
TPSC686*010T0200	C	68	10	6.8	6	200	1	0.742	0.667	0.297	0.148	0.133	0.059
TPSC686*010T0300	C	68	10	6.8	6	300	1	0.606	0.545	0.242	0.182	0.163	0.073
TPSD686*010T0150V	D	68	10	6.8	6	150	3	1.000	0.900	0.400	0.150	0.135	0.060
TPSC107*010T0150	C	100	10	10	8	150	1	0.856	0.771	0.343	0.128	0.116	0.051
TPSC107*010T0200	C	100	10	10	8	200	1	0.742	0.667	0.297	0.148	0.133	0.059
TPSD107*010T0100V	D	100	10	10	6	100	3	1.225	1.102	0.490	0.122	0.110	0.049
TPSD107*010T0125V	D	100	10	10	6	125	3	1.095	0.986	0.438	0.137	0.123	0.055
TPSD107*010T0150V	D	100	10	10	6	150	3	1.000	0.900	0.400	0.150	0.135	0.060
TPSD157*010T0085V	D	150	10	15	8	85	3	1.328	1.196	0.531	0.113	0.102	0.045
TPSD157*010T0100V	D	150	10	15	8	100	3	1.225	1.102	0.490	0.122	0.110	0.049
TPSE157*010T0100V	E	150	10	15	8	100	3	1.285	1.156	0.514	0.128	0.116	0.051
TPSD227*010T0100V	D	220	10	22	8	100	3	1.225	1.102	0.490	0.122	0.110	0.049
TPSD227*010T0150V	D	220	10	22	8	150	3	1.000	0.900	0.400	0.150	0.135	0.060
TPSE227*010T0070V	E	220	10	22	8	70	3	1.535	1.382	0.614	0.107	0.097	0.043
TPSE227*010T0100V	E	220	10	22	8	100	3	1.285	1.156	0.514	0.128	0.116	0.051
TPSE227*010T0125V	E	220	10	22	8	125	3	1.149	1.034	0.460	0.144	0.129	0.057
TPSE227*010T0150V	E	220	10	22	8	150	3	1.049	0.944	0.420	0.157	0.142	0.063
TPSE337*010T0050V	E	330	10	33	8	50	3	1.817	1.635	0.727	0.091	0.082	0.036
TPSE337*010T0060V	E	330	10	33	8	60	3	1.658	1.492	0.663	0.099	0.090	0.040
TPSE337*010T0100V	E	330	10	33	8	100	3	1.285	1.156	0.514	0.128	0.116	0.051
16 Volt @ 85°C (10 Volt @ 25°C)													
TPSA105*016T6200	A	1.0	16	0.5	4	6200	1	0.110	0.099	0.044	0.682	0.614	0.273
TPSA225*016T1800	A	2.2	16	0.5	6	1800	1	0.204	0.184	0.082	0.367	0.331	0.147
TPSA225*016T3500	A	2.2	16	0.5	6	3500	1	0.146	0.132	0.059	0.512	0.461	0.205
TPSA335*016T3500	A	3.3	16	0.5	6	3500	1	0.146	0.132	0.059	0.512	0.461	0.205
TPSB335*016T2500	B	3.3	16	0.5	6	2500	1	0.184	0.166	0.074	0.461	0.415	0.184
TPSA475*016T2000	A	4.7	16	0.8	6	2000	1	0.194	0.174	0.077	0.387	0.349	0.155
TPSB475*016T0800	B	4.7	16	0.8	6	800	1	0.326	0.293	0.130	0.261	0.235	0.104
TPSB475*016T1500	B	4.7	16	0.8	6	1500	1	0.238	0.214	0.095	0.357	0.321	0.143
TPSA685*016T1500	A	6.8	16	1.1	6	1500	1	0.224	0.201	0.089	0.335	0.302	0.134
TPSB685*016T0600	B	6.8	16	1.1	6	600	1	0.376	0.339	0.151	0.226	0.203	0.090
TPSB685*016T1200	B	6.8	16	1.1	6	1200	1	0.266	0.240	0.106	0.319	0.287	0.128
TPSA106*016T1000	A	10	16	1.6	6	1000	1	0.274	0.246	0.110	0.274	0.246	0.110
TPSB106*016T0500	B	10	16	1.6	6	500	1	0.412	0.371	0.165	0.206	0.186	0.082
TPSB106*016T0800	B	10	16	1.6	6	800	1	0.326	0.293	0.130	0.261	0.235	0.104
TPSC106*016T0500	C	10	16	1.6	6	500	1	0.469	0.422	0.188	0.235	0.211	0.094
TPSB156*016T0500	B	15	16	2.4	6	500	1	0.412	0.371	0.165	0.206	0.186	0.082
TPSB156*016T0800	B	15	16	2.4	6	800	1	0.326	0.293	0.130	0.261	0.235	0.104
TPSC156*016T0700	C	15	16	2.4	6	700	1	0.396	0.357	0.159	0.277	0.250	0.111
TPSB226*016T0400	B	22	16	3.5	6	400	1	0.461	0.415	0.184	0.184	0.166	0.074
TPSB226*016T0600	B	22	16	3.5	6	600	1	0.376	0.339	0.151	0.226	0.203	0.090
TPSC226*016T0300	C	22	16	3.5	6	300	1	0.606	0.545	0.242	0.182	0.163	0.073
TPSC226*016T0375	C	22	16	3.5	6	375	1	0.542	0.487	0.217	0.203	0.183	0.081
TPSD226*016T0700V	D	22	16	3.5	6	700	3	0.463	0.417	0.185	0.324	0.292	0.130
TPSC336*016T0225	C	33	16	5.3	6	225	1	0.699	0.629	0.280	0.157	0.142	0.063
TPSC336*016T0300	C	33	16	5.3	6	300	1	0.606	0.545	0.242	0.182	0.163	0.073
TPSD336*016T0200V	D	33	16	5.3	6	200	3	0.866	0.779	0.346	0.173	0.156	0.069
TPSC476*016T0350	C	47	16	7.5	6	350	1	0.561	0.505	0.224	0.196	0.177	0.078
TPSD476*016T0200V	D	47	16	7.5	6	200	3	0.866	0.779	0.346	0.173	0.156	0.069
TPSC686*016T0200	C	68	16	10.9	6	200	1	0.742	0.667	0.297	0.148	0.133	0.059
TPSD686*016T0150V	D	68	16	10.9	6	150	3	1.000	0.900	0.400	0.150	0.135	0.060
TPSD107*016T0100V	D	100	16	16	6	100	3	1.225	1.102	0.490	0.122	0.110	0.049
TPSD107*016T0125V	D	100	16	16	6	125	3	1.095	0.986	0.438	0.137	0.123	0.055

Moinstone Sensitivity Level (MSL) is defined according to J-STD-020

*Please use "U" instead of "T" in the suffix letter for 13" reel packaging

Please use specific PN for automotive version - see "HOW TO ORDER".

All technical data relates to an ambient temperature of +25°C. Capacitance and DF are measured at 120Hz, 0.5V RMS with a maximum DC bias of 2.2 volts. DCL is measured at rated voltage after 5 minutes.

The EIA & CECC standards for low ESR Solid Tantalum Capacitors allow an ESR movement to 1.25 times catalogue limit post mounting.

For typical weight and composition see page 144.

NOTE: AVX reserves the right to supply a higher voltage rating or tighter tolerance part in the same case size, to the same reliability standards.



TPS Automotive Range

Low ESR - Automotive Product Range



RATINGS & PART NUMBER REFERENCE

AVX Part No.*	Case Size	Capacitance (µF)	Rated Voltage (V)	DCL (µA) Max.	DF % Max.	ESR Max. (mΩ) @100kHz	MSL	100kHz RMS Current (A)			100kHz RMS Voltage (V)		
								25°C	85°C	125°C	25°C	85°C	125°C
TPSD107*016T0150V	D	100	16	16	6	150	3	1.000	0.900	0.400	0.150	0.135	0.060
TPSE107*016T0100V	E	100	16	16	6	100	3	1.285	1.156	0.514	0.128	0.116	0.051
TPSE107*016T0125V	E	100	16	16	6	125	3	1.149	1.034	0.460	0.144	0.129	0.057
TPSE107*016T0150V	E	100	16	16	6	150	3	1.049	0.944	0.420	0.157	0.142	0.063
TPSE157*016T0100V	E	150	16	23	8	100	3	1.285	1.156	0.514	0.128	0.116	0.051
20 Volt @ 85°C (13 Volt @ 125°C)													
TPSA105*020T3000	A	1	20	0.5	4	3000	1	0.158	0.142	0.063	0.474	0.427	0.190
TPSA155*020T3000	A	1.5	20	0.5	6	3000	1	0.158	0.142	0.063	0.474	0.427	0.190
TPSA225*020T3000	A	2.2	20	0.5	6	3000	1	0.158	0.142	0.063	0.474	0.427	0.190
TPSB225*020T1700	B	2.2	20	0.5	6	1700	1	0.224	0.201	0.089	0.380	0.342	0.152
TPSA335*020T2500	A	3.3	20	0.7	6	2500	1	0.173	0.156	0.069	0.433	0.390	0.173
TPSB335*020T1300	B	3.3	20	0.7	6	1300	1	0.256	0.230	0.102	0.332	0.299	0.133
TPSA475*020T1800	A	4.7	20	0.9	6	1800	1	0.204	0.184	0.082	0.367	0.331	0.147
TPSB475*020T0750	B	4.7	20	0.9	6	750	1	0.337	0.303	0.135	0.252	0.227	0.101
TPSB475*020T1000	B	4.7	20	0.9	6	1000	1	0.292	0.262	0.117	0.292	0.262	0.117
TPSB685*020T0600	B	6.8	20	1.4	6	600	1	0.376	0.339	0.151	0.226	0.203	0.090
TPSB685*020T1000	B	6.8	20	1.4	6	1000	1	0.292	0.262	0.117	0.292	0.262	0.117
TPSC685*020T0700	C	6.8	20	1.4	6	700	1	0.396	0.357	0.159	0.277	0.250	0.111
TPSB106*020T0500	B	10	20	2	6	500	1	0.412	0.371	0.165	0.206	0.186	0.082
TPSB106*020T1000	B	10	20	2	6	1000	1	0.292	0.262	0.117	0.292	0.262	0.117
TPSC106*020T0500	C	10	20	2	6	500	1	0.469	0.422	0.188	0.235	0.211	0.094
TPSC106*020T0700	C	10	20	2	6	700	1	0.396	0.357	0.159	0.277	0.250	0.111
TPSB156*020T0500	B	15	20	3	6	500	1	0.412	0.371	0.165	0.206	0.186	0.082
TPSC156*020T0400	C	15	20	3	6	400	1	0.524	0.472	0.210	0.210	0.189	0.084
TPSC156*020T0450	C	15	20	3	6	450	1	0.494	0.445	0.198	0.222	0.200	0.089
TPSC226*020T0400	C	22	20	4.4	6	400	1	0.524	0.472	0.210	0.210	0.189	0.084
TPSD226*020T0200V	D	22	20	4.4	6	200	3	0.866	0.779	0.346	0.173	0.156	0.069
TPSD226*020T0300V	D	22	20	4.4	6	300	3	0.707	0.636	0.283	0.212	0.191	0.085
TPSC336*020T0300	C	33	20	6.6	6	300	1	0.606	0.545	0.242	0.182	0.163	0.073
TPSD336*020T0200V	D	33	20	6.6	6	200	3	0.866	0.779	0.346	0.173	0.156	0.069
TPSD476*020T0200V	D	47	20	9.4	6	200	3	0.866	0.779	0.346	0.173	0.156	0.069
TPSD686*020T0150V	D	68	20	13.6	6	150	3	1.000	0.900	0.400	0.150	0.135	0.060
TPSD686*020T0200V	D	68	20	13.6	6	200	3	0.866	0.779	0.346	0.173	0.156	0.069
TPSD686*020T0300V	D	68	20	13.6	6	300	3	0.707	0.636	0.283	0.212	0.191	0.085
TPSE686*020T0125V	E	68	20	13.6	6	125	3	1.149	1.034	0.460	0.144	0.129	0.057
TPSE686*020T0150V	E	68	20	13.6	6	150	3	1.049	0.944	0.420	0.157	0.142	0.063
TPSE686*020T0200V	E	68	20	13.6	6	200	3	0.908	0.817	0.363	0.182	0.163	0.073
TPSE107*020T0100V	E	100	20	20	6	100	3	1.285	1.156	0.514	0.128	0.116	0.051
TPSE107*020T0150V	E	100	20	20	6	150	3	1.049	0.944	0.420	0.157	0.142	0.063
TPSE107*020T0200V	E	100	20	20	6	200	3	0.908	0.817	0.363	0.182	0.163	0.073
25 Volt @ 85°C (17 Volt @ 125°C)													
TPSA474*025T17000	A	0.47	25	0.5	4	7000	1	0.104	0.093	0.041	0.725	0.652	0.290
TPSA684*025T6000	A	0.68	25	0.5	4	6000	1	0.112	0.101	0.045	0.671	0.604	0.268
TPSA105*025T4000	A	1.0	25	0.5	4	4000	1	0.137	0.123	0.055	0.548	0.493	0.219
TPSA155*025T3000	A	1.5	25	0.5	6	3000	1	0.158	0.142	0.063	0.474	0.427	0.190
TPSA225*025T2500	A	2.2	25	0.6	6	2500	1	0.173	0.156	0.069	0.433	0.390	0.173
TPSB225*025T0900	B	2.2	25	0.6	6	900	1	0.307	0.277	0.123	0.277	0.249	0.111
TPSB225*025T1200	B	2.2	25	0.6	6	1200	1	0.266	0.240	0.106	0.319	0.287	0.128
TPSB225*025T2500	B	2.2	25	0.6	6	2500	1	0.184	0.166	0.074	0.461	0.415	0.184
TPSB335*025T0750	B	3.3	25	0.8	6	750	1	0.337	0.303	0.135	0.252	0.227	0.101
TPSB335*025T1500	B	3.3	25	0.8	6	1500	1	0.238	0.214	0.095	0.357	0.321	0.143
TPSB335*025T2000	B	3.3	25	0.8	6	2000	1	0.206	0.186	0.082	0.412	0.371	0.165
TPSB475*025T0700	B	4.7	25	1.2	6	700	1	0.348	0.314	0.139	0.244	0.220	0.098
TPSB475*025T0900	B	4.7	25	1.2	6	900	1	0.307	0.277	0.123	0.277	0.249	0.111
TPSC475*025T0700	C	4.7	25	1.2	6	700	1	0.396	0.357	0.159	0.277	0.250	0.111
TPSB685*025T0700	B	6.8	25	1.7	6	700	1	0.348	0.314	0.139	0.244	0.220	0.098
TPSC685*025T0500	C	6.8	25	1.7	6	500	1	0.469	0.422	0.188	0.235	0.211	0.094
TPSC685*025T0600	C	6.8	25	1.7	6	600	1	0.428	0.385	0.171	0.257	0.231	0.103
TPSC685*025T0700	C	6.8	25	1.7	6	700	1	0.396	0.357	0.159	0.277	0.250	0.111
TPSC106*025T0300	C	10	25	2.5	6	300	1	0.606	0.545	0.242	0.182	0.163	0.073
TPSC106*025T0500	C	10	25	2.5	6	500	1	0.469	0.422	0.188	0.235	0.211	0.094
TPSD106*025T0500V	D	10	25	2.5	6	500	3	0.548	0.493	0.219	0.274	0.246	0.110
TPSC156*025T0220	C	15	25	3.8	6	220	1	0.707	0.636	0.283	0.156	0.140	0.062
TPSC156*025T0300	C	15	25	3.8	6	300	1	0.606	0.545	0.242	0.182	0.163	0.073
TPSD156*025T0300V	D	15	25	3.8	6	300	3	0.707	0.636	0.283	0.212	0.191	0.085
TPSC226*025T0275	C	22	25	5.5	6	275	1	0.632	0.569	0.253	0.174	0.157	0.070
TPSC226*025T0400	C	22	25	5.5	6	400	1	0.524	0.472	0.210	0.210	0.189	0.084

Moisture Sensitivity Level (MSL) is defined according to J-STD-020

*Please use "U" instead of "T" in the suffix letter for 13" reel packaging

Please use specific PN for automotive version - see "HOW TO ORDER".

All technical data relates to an ambient temperature of +25°C. Capacitance and DF are measured at 120Hz, 0.5V RMS with a maximum DC bias of 2.2 volts. DCL is measured at rated voltage after 5 minutes.

The EIA & CECC standards for low ESR Solid Tantalum Capacitors allow an ESR movement to 1.25 times catalogue limit post mounting.

For typical weight and composition see page 144.

NOTE: AVX reserves the right to supply a higher voltage rating or tighter tolerance part in the same case size, to the same reliability standards.



TPS Automotive Range



Low ESR - Automotive Product Range

RATINGS & PART NUMBER REFERENCE

AVX Part No.*	Case Size	Capacitance (µF)	Rated Voltage (V)	DCL (µA) Max.	DF % Max.	ESR Max. (mΩ) @100kHz	MSL	100kHz RMS Current (A)			100kHz RMS Voltage (V)		
								25°C	85°C	125°C	25°C	85°C	125°C
TPSD226*025T0200V	D	22	25	5.5	6	200	3	0.866	0.779	0.346	0.173	0.156	0.069
TPSD226*025T0300V	D	22	25	5.5	6	300	3	0.707	0.636	0.283	0.212	0.191	0.085
TPSD336*025T0200V	D	33	25	8.3	6	200	3	0.866	0.779	0.346	0.173	0.156	0.069
TPSD336*025T0300V	D	33	25	8.3	6	300	3	0.707	0.636	0.283	0.212	0.191	0.085
TPSD476*025T0125V	D	47	25	11.8	6	125	3	1.095	0.986	0.438	0.137	0.123	0.055
TPSD476*025T0150V	D	47	25	11.8	6	150	3	1.000	0.900	0.400	0.150	0.135	0.060
TPSD476*025T0250V	D	47	25	11.8	6	250	3	0.775	0.697	0.310	0.194	0.174	0.077
TPSE476*025T0125V	E	47	25	11.8	6	125	3	1.149	1.034	0.460	0.144	0.129	0.057
35 Volt @ 85°C (23 Volt @ 125°C)													
TPSA334*035T6000	A	0.33	35	0.5	4	6000	1	0.112	0.101	0.045	0.671	0.604	0.268
TPSA474*035T6000	A	0.47	35	0.5	4	6000	1	0.112	0.101	0.045	0.671	0.604	0.268
TPSA684*035T6000	A	0.68	35	0.5	4	6000	1	0.112	0.101	0.045	0.671	0.604	0.268
TPSA105*035T3000	A	1	35	0.5	4	3000	1	0.158	0.142	0.063	0.474	0.427	0.190
TPSB105*035T2000	B	1	35	0.5	4	2000	1	0.206	0.186	0.082	0.412	0.371	0.165
TPSA155*035T3000	A	1.5	35	0.5	6	3000	1	0.158	0.142	0.063	0.474	0.427	0.190
TPSB155*035T2500	B	1.5	35	0.5	6	2500	1	0.184	0.166	0.074	0.461	0.415	0.184
TPSB225*035T0750	B	2.2	35	0.8	6	750	1	0.337	0.303	0.135	0.252	0.227	0.101
TPSB225*035T1500	B	2.2	35	0.8	6	1500	1	0.238	0.214	0.095	0.357	0.321	0.143
TPSB225*035T2000	B	2.2	35	0.8	6	2000	1	0.206	0.186	0.082	0.412	0.371	0.165
TPSC225*035T1000	C	2.2	35	0.8	6	1000	1	0.332	0.298	0.133	0.332	0.298	0.133
TPSB335*035T1000	B	3.3	35	1.2	6	1000	1	0.292	0.262	0.117	0.292	0.262	0.117
TPSC335*035T0700	C	3.3	35	1.2	6	700	1	0.396	0.357	0.159	0.277	0.250	0.111
TPSB475*035T0700	B	4.7	35	1.6	6	700	1	0.348	0.314	0.139	0.244	0.220	0.098
TPSB475*035T1500	B	4.7	35	1.6	6	1500	1	0.238	0.214	0.095	0.357	0.321	0.143
TPSC475*035T0600	C	4.7	35	1.6	6	600	1	0.428	0.385	0.171	0.257	0.231	0.103
TPSD475*035T0700V	D	4.7	35	1.6	6	700	3	0.463	0.417	0.185	0.324	0.292	0.130
TPSC685*035T0350	C	6.8	35	2.4	6	350	1	0.561	0.505	0.224	0.196	0.177	0.078
TPSD685*035T0400V	D	6.8	35	2.4	6	400	3	0.612	0.551	0.245	0.245	0.220	0.098
TPSD685*035T0500V	D	6.8	35	2.4	6	500	3	0.548	0.493	0.219	0.274	0.246	0.110
TPSC106*035T0600	C	10	35	3.5	6	600	1	0.428	0.385	0.171	0.257	0.231	0.103
TPSD106*035T0300V	D	10	35	3.5	6	300	3	0.707	0.636	0.283	0.212	0.191	0.085
TPSD156*035T0300V	D	15	35	5.3	6	300	3	0.707	0.636	0.283	0.212	0.191	0.085
TPSD226*035T0200V	D	22	35	7.7	6	200	3	0.866	0.779	0.346	0.173	0.156	0.069
TPSD226*035T0300V	D	22	35	7.7	6	300	3	0.707	0.636	0.283	0.212	0.191	0.085
TPSD226*035T0400V	D	22	35	7.7	6	400	3	0.612	0.551	0.245	0.245	0.220	0.098
TPSE226*035T0200V	E	22	35	7.7	6	200	3	0.908	0.817	0.363	0.182	0.163	0.073
TPSE226*035T0300V	E	22	35	7.7	6	300	3	0.742	0.667	0.297	0.222	0.200	0.089
TPSE336*035T0250V	E	33	35	11.6	6	250	3	0.812	0.731	0.325	0.203	0.183	0.081
TPSE336*035T0300V	E	33	35	11.6	6	300	3	0.742	0.667	0.297	0.222	0.200	0.089
50 Volt @ 85°C (33 Volt @ 125°C)													
TPSA224*050T7000	A	0.22	50	0.5	4	7000	1	0.104	0.093	0.041	0.725	0.652	0.290
TPSA334*050T7000	A	0.33	50	0.5	4	7000	1	0.104	0.093	0.041	0.725	0.652	0.290
TPSA474*050T6500	A	0.47	50	0.5	4	6500	1	0.107	0.097	0.043	0.698	0.628	0.279
TPSB474*050T6000	B	0.47	50	0.5	4	6000	1	0.119	0.107	0.048	0.714	0.643	0.286
TPSB684*050T4000	B	0.68	50	0.5	4	4000	1	0.146	0.131	0.058	0.583	0.525	0.233
TPSB105*050T3000	B	1	50	0.5	6	3000	1	0.168	0.151	0.067	0.505	0.454	0.202
TPSC105*050T2500	C	1	50	0.5	4	2500	1	0.210	0.189	0.084	0.524	0.472	0.210
TPSC155*050T1500	C	1.5	50	0.8	6	1500	1	0.271	0.244	0.108	0.406	0.366	0.162
TPSC155*050T2000	C	1.5	50	0.8	6	2000	1	0.235	0.211	0.094	0.469	0.422	0.188
TPSC225*050T1500	C	2.2	50	1.1	8	1500	1	0.271	0.244	0.108	0.406	0.366	0.162
TPSD225*050T1200V	D	2.2	50	1.1	6	1200	3	0.354	0.318	0.141	0.424	0.382	0.170
TPSC335*050T1000	C	3.3	50	1.6	6	1000	1	0.332	0.298	0.133	0.332	0.298	0.133
TPSD335*050T0800V	D	3.3	50	1.7	6	800	3	0.433	0.390	0.173	0.346	0.312	0.139
TPSC475*050T0800	C	4.7	50	2.4	6	800	1	0.371	0.334	0.148	0.297	0.267	0.119
TPSD475*050T0500V	D	4.7	50	2.4	6	500	3	0.548	0.493	0.219	0.274	0.246	0.110
TPSD475*050T0700V	D	4.7	50	2.4	6	700	3	0.463	0.417	0.185	0.324	0.292	0.130
TPSD685*050T0500V	D	6.8	50	3.4	6	500	3	0.548	0.493	0.219	0.274	0.246	0.110
TPSD685*050T0600V	D	6.8	50	3.4	6	600	3	0.500	0.450	0.200	0.300	0.270	0.120
TPSD106*050T0500V	D	10	50	5	6	500	3	0.548	0.493	0.219	0.274	0.246	0.110
TPSE106*050T0250V	E	10	50	5	6	250	3	0.812	0.731	0.325	0.203	0.183	0.081
TPSE106*050T0300V	E	10	50	5	6	300	3	0.742	0.667	0.297	0.222	0.200	0.089
TPSE106*050T0400V	E	10	50	5	6	400	3	0.642	0.578	0.257	0.257	0.231	0.103
TPSE106*050T0500V	E	10	50	5	6	500	3	0.574	0.517	0.230	0.287	0.259	0.115
TPSE156*050T0250V	E	15	50	7.5	6	250	3	0.812	0.731	0.325	0.203	0.183	0.081

Moisture Sensitivity Level (MSL) is defined according to J-STD-020

*Please use "U" instead of "T" in the suffix letter for 13" reel packaging

Please use specific PN for automotive version - see "HOW TO ORDER".

All technical data relates to an ambient temperature of +25°C. Capacitance and DF are measured at 120Hz, 0.5V RMS with a maximum DC bias of 2.2 volts. DCL is measured at rated voltage after 5 minutes.

The EIA & CECC standards for low ESR Solid Tantalum Capacitors allow an ESR movement to 1.25 times catalogue limit post mounting.

For typical weight and composition see page 144.

NOTE: AVX reserves the right to supply a higher voltage rating or tighter tolerance part in the same case size, to the same reliability standards.



F91 Series



Low ESR, Resin-Molded Chip J-Lead



For SMD



For High Frequency

- Compliant to the RoHS directive (2002/95/EC).

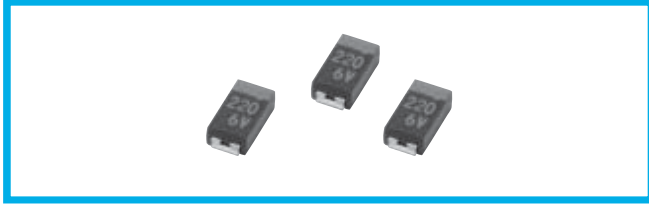

Type numbering system (Example: 10V 100μF)

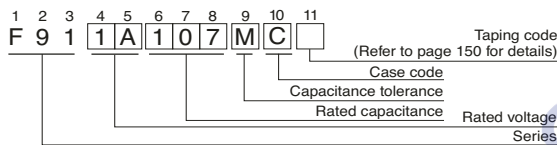

Drawing

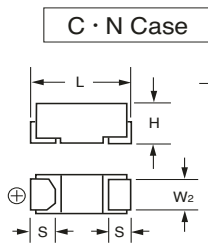

Dimensions

Case Code	L	W ₁	W ₂	H	S
C	6.0 ± 0.2	3.2 ± 0.2	2.2 ± 0.1	2.5 ± 0.2	1.3 ± 0.2
N	7.3 ± 0.2	4.3 ± 0.2	2.4 ± 0.1	2.8 ± 0.2	1.3 ± 0.2

Marking

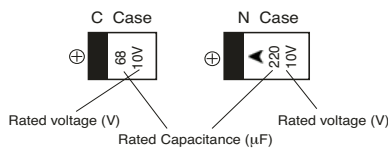

Standard Ratings

Cap. (μF)	Code	V		
		4	6.3	10
68	686	0G	0J	1A
100	107		C	C
150	157	C	C	N
220	227	C	C · N	N
330	337	N	N	N
470	477	N	N	
680	687	N		

Specifications

Item	Performance Characteristics
Category	
Temperature Range	-55 to +125°C (Rated temperature : +85°C)
Capacitance Tolerance	±20%, ±10% (at 120Hz)
Dissipation Factor (120Hz)	Refer to the table below.
ESR (100kHz)	Refer to the table below.
Leakage Current	<ul style="list-style-type: none"> After 1 minute's application of rated voltage, leakage current at 20°C is not more than 0.01CV or 0.5μA, whichever is greater. After 1 minute's application of rated voltage, leakage current at 85°C is not more than 0.1CV or 5μA, whichever is greater. After 1 minute's application of derated voltage, leakage current at 125°C is not more than 0.125CV or 6.3μA, whichever is greater.
Capacitance Change by Temperature	+15% Max. (at +125°C) +10% Max. (at +85°C) -10% Max. (at -55°C)
Damp Heat (Steady State)	At 40°C 90 to 95% R.H. 500 hours (No voltage applied) Capacitance Change Within ±10% of the initial value Dissipation Factor.....Initial specified value or less Leakage Current.....Initial specified value or less
Temperature Cycles	-55°C / +125°C 30 minutes each 5 cycles Capacitance Change Within ±5% of the initial value Dissipation Factor.....Initial specified value or less Leakage Current.....Initial specified value or less
Resistance to Soldering Heat	10 seconds reflow at 260°C, 5 seconds immersion at 260°C Capacitance Change Within ±5% of the initial value Dissipation Factor.....Initial specified value or less Leakage Current.....Initial specified value or less
Surge	After application of surge in series with a 33Ω resistor at the rate of 30 seconds ON, 30 seconds OFF, for 1000 successive test cycles at 85°C, capacitors shall meet the characteristic requirements table below. Capacitance Change.....Within ±5% of the initial value Dissipation Factor.....Initial specified value or less Leakage Current.....Initial specified value or less
Endurance	After 2000 hours' application of rated voltage in series with a 3Ω resistor at 85°C, or derated voltage in series with a 3Ω resistor at 125°C, capacitors shall meet the characteristics requirements table below. Capacitance Change.....Within ±10% of the initial value Dissipation Factor.....Initial specified value or less Leakage Current.....Initial specified value or less
Shear Test	After applying the pressure load of 5N for 10±1 seconds horizontally to the center of capacitor side body which has no electrode and has been soldered beforehand on a substrate, there shall be found neither exfoliation nor its sign at the terminal electrode. 5N (0.51 kg · f) For 10±1 seconds
Terminal Strength	Keeping a capacitor surface-mounted on a substrate upside down and supporting the substrate at both of the opposite bottom points 45mm apart from the center of capacitor, the pressure strength is applied with a specified jig at the center of substrate so that the substrate may bend by 1mm as illustrated. Then, there shall be found no remarkable abnormality on the capacitor terminals. R230 20 45 45 1mm

Rated Volt	Rated Capacitance (μF)	Case code	Part Number	Leakage Current (μA)	Dissipation Factor (% @120Hz)	ESR (mΩ @100kHz)
4V	150	C	F910G157MCC	6.0	12	250
	220	C	F910G227MCC	8.8	12	250
	330	N	F910G337MNC	13.2	10	100
	470	N	F910G477MNC	18.8	16	100
	680	N	F910G687MNC	27.2	18	100
6.3V	100	C	F910J107MCC	6.3	8	250
	150	C	F910J157MCC	9.5	12	250
	220	C	F910J227MCC	13.9	14	250
	220	N	F910J227MNC	13.9	10	100
	330	N	F910J337MNC	20.8	14	100
	470	N	F910J477MNC	29.6	16	100
10V	68	C	F911A686MCC	6.8	8	300
	100	C	F911A107MCC	10.0	10	250
	150	N	F911A157MNC	15.0	10	100
	220	N	F911A227MNC	22.0	12	100
	330	N	F911A337MNC	33.0	18	100

* In case of capacitance tolerance ± 10% type, [K] will be put at 9th digit of type numbering system.

TPM Multianode



Tantalum Ultra Low ESR Capacitor

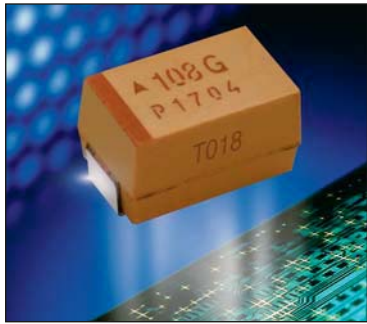

- Multi-anode construction
- Super low ESR
- CV range: 10-2200 μ F / 2.5-50V
- 4 case sizes available
- "Mirror" multi-anode construction used with D case capacitors reduces ESL to half



SnPb termination option is not RoHS compliant.

MULTIANODE CONSTRUCTION

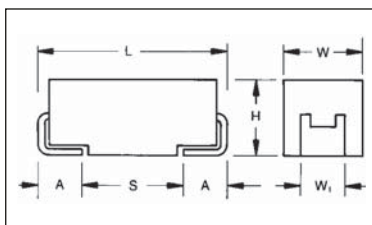
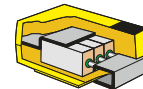

For part marking see page 151

CASE DIMENSIONS: millimeters (inches)

Code	EIA Code	EIA Metric	L \pm 0.20 (0.008)	W \pm 0.20 (0.008) -0.10 (0.004)	H \pm 0.20 (0.008) -0.10 (0.004)	W \pm 0.20 (0.008)	A \pm 0.30 (0.012) -0.20 (0.008)	S Min.
D	2917	7343-31	7.30 (0.287)	4.30 (0.169)	2.90 (0.114)	2.40 (0.094)	1.30 (0.051)	4.40 (0.173)
E	2917	7343-43	7.30 (0.287)	4.30 (0.169)	4.10 (0.162)	2.40 (0.094)	1.30 (0.051)	4.40 (0.173)
V	2924	7361-38	7.30 (0.287)	6.10 (0.240)	3.55 (0.140)	3.10 (0.120)	1.30 (0.051)	4.40 (0.173)
Y	2917	7343-20	7.30 (0.287)	4.30 (0.169)	2.00 (0.079) max	2.40 (0.094)	1.30 (0.051)	4.40 (0.173)

W1 dimension applies to the termination width for A dimensional area only.

HOW TO ORDER

TPM

Type

E

Case Size
See table above

108

Capacitance Code
pF code: 1st two digits represent significant figures, 3rd digit represents multiplier (number of zeros to follow)

M

Tolerance
K=±10%
M=±20%

004

Rated DC Voltage
002=2.5Vdc
004=4Vdc
006=6.3Vdc
010=10Vdc
016=16Vdc
020=20Vdc
025=25Vdc
035=35Vdc
050=50Vdc

R

Packaging
R = Pure Tin 7" Reel
S = Pure Tin 13" Reel
H = Tin Lead 7" Reel (Contact Manufacturer)
K = Tin Lead 13" Reel (Contact Manufacturer)
H, K = Non RoHS

0018

ESR in m Ω

TECHNICAL SPECIFICATIONS

Technical Data:	All technical data relate to an ambient temperature of +25°C									
Capacitance Range:	10 μ F to 2200 μ F									
Capacitance Tolerance:	\pm 10%, \pm 20%									
Rated Voltage (V_R)	\leq +85°C:	2.5	4	6.3	10	16	20	25	35	50
Category Voltage (V_C)	\leq +125°C:	1.7	2.7	4	7	10	13	17	23	33
Surge Voltage (V_S)	\leq +85°C:	3.3	5.2	8	13	20	26	32	46	65
Surge Voltage (V_S)	\leq +125°C:	2.2	3.4	5	8	13	16	20	28	40
Temperature Range:	-55°C to +125°C									
Reliability:	1% per 1000 hours at 85°C, V_R with 0.1 Ω /V series impedance, 60% confidence level									

TPM Multianode



Tantalum Ultra Low ESR Capacitor

CAPACITANCE AND RATED VOLTAGE, VR (VOLTAGE CODE) RANGE (LETTER DENOTES CASE SIZE)

Capacitance		Rated Voltage DC (V _R) to 85°C								
μF	Code	2.5V (e)	4V (G)	6.3V (J)	10V (A)	16V (C)	20V (D)	25V (E)	35V (V)	50V (T)
6.8	685									
10	106									D(140) E(120)
15	156									E(75,100)
22	226								D(70) E(60,100)	E(75,100)
33	336							D(65)	E(50,65)	
47	476						D(45,55)	D(55)/E(65)	E(55,65)	
68	686					D(40,50)		E(45,55)		
100	107				Y(45) ^(M)	D(40,50)	E(35,45)			
150	157				Y(45) ^(M)	E(30,40)	E(35)			
220	227			Y(30) ^(M)	D(35)	E(25,40)				
330	337		D(25,35)	D(25,35)	D(35) E(23,35)	E(60)				
470	477		D(25,35)	D(30) E(18,23,30)	E(23,30)					
680	687		D(25) E(18,23)	E(18,23) V(23)						
1000	108	D(25)	D(25,45) E(18,23), V(18)	E(25) ^(M) V(20) ^(M)						
1500	158	E(12,15,18)	E(15,18)							
2200	228	E(18) ^(M)								

Released codes ^(M tolerance only)

Engineering samples - please contact manufacturer

*Codes under development - subject to change

Note: Voltage ratings are minimum values. AVX reserves the right to supply higher ratings in the same case size, to the same reliability standards.

TPM Multianode

Tantalum Ultra Low ESR Capacitor



RATINGS & PART NUMBER REFERENCE

AVX Part No.	Case Size	Capacitance (µF)	Rated Voltage (V)	DCL (µA) Max.	DF % Max.	ESR Max. (mΩ) @100kHz	MSL	100kHz RMS Current (A)			100kHz RMS Voltage (V)		
								25°C	85°C	125°C	25°C	85°C	125°C
2.5 Volt @ 85°C (1.7 Volt @ 125°C)													
TPMD108*002#0025	D	1000	2.5	25	8	25	3	3.194	2.874	1.277	0.080	0.072	0.032
TPME158*002#0012	E	1500	2.5	38	6	12	3	4.743	4.269	1.897	0.057	0.051	0.023
TPME158*002#0015	E	1500	2.5	38	6	15	3	4.243	3.818	1.697	0.064	0.057	0.025
TPME158*002#0018	E	1500	2.5	38	6	18	3	3.873	3.486	1.549	0.070	0.063	0.028
TPME228M002#0018	E	2200	2.5	44	10	18	3	3.873	3.486	1.549	0.070	0.063	0.028
4 Volt @ 85°C (2.7 Volt @ 125°C)													
TPMD337*004#0025	D	330	4	13.2	8	25	3	3.194	2.874	1.277	0.080	0.072	0.032
TPMD337*004#0035	D	330	4	13.2	8	35	3	2.699	2.429	1.080	0.094	0.085	0.038
TPMD477*004#0025	D	470	4	18.8	8	25	3	3.194	2.874	1.277	0.080	0.072	0.032
TPMD477*004#0035	D	470	4	18.8	8	35	3	2.699	2.429	1.080	0.094	0.085	0.038
TPMD687*004#0025	D	680	4	27.2	8	25	3	3.194	2.874	1.277	0.080	0.072	0.032
TPME687*004#0018	E	680	4	27	6	18	3	3.873	3.486	1.549	0.070	0.063	0.028
TPME687*004#0023	E	680	4	27	6	23	3	3.426	3.084	1.370	0.079	0.071	0.032
TPMD108*004#0025	D	1000	4	40	8	25	3	3.194	2.874	1.277	0.080	0.072	0.032
TPMD108*004#0045	D	1000	4	40	8	45	3	2.380	2.142	0.952	0.107	0.096	0.043
TPME108*004#0018	E	1000	4	40	6	18	3	3.873	3.486	1.549	0.070	0.063	0.028
TPME108*004#0023	E	1000	4	40	6	23	3	3.426	3.084	1.370	0.079	0.071	0.032
TPMV108*004#0018	V	1000	4	40	6	18	3	3.979	3.581	1.592	0.072	0.064	0.029
TPME158*004#0015	E	1500	4	40	6	15	3	4.243	3.818	1.697	0.064	0.057	0.025
TPME158*004#0018	E	1500	4	40	6	18	3	3.873	3.486	1.549	0.070	0.063	0.028
6.3 Volt @ 85°C (4 Volt @ 125°C)													
TPMY227M006#0030	Y	220	6.3	13.2	6	30	3	2.646	2.381	1.058	0.079	0.071	0.032
TPMD337*006#0025	D	330	6.3	19.8	8	25	3	3.194	2.874	1.277	0.080	0.072	0.032
TPMD337*006#0035	D	330	6.3	19.8	8	35	3	2.699	2.429	1.080	0.094	0.085	0.038
TPMD477*006#0030	D	470	6.3	28.2	8	30	3	2.915	2.624	1.166	0.087	0.079	0.035
TPME477*006#0018	E	470	6.3	28	6	18	3	3.873	3.486	1.549	0.070	0.063	0.028
TPME477*006#0023	E	470	6.3	28	6	23	3	3.426	3.084	1.370	0.079	0.071	0.032
TPME477*006#0030	E	470	6.3	28	6	30	3	3.000	2.700	1.200	0.090	0.081	0.036
TPME687*006#0018	E	680	6.3	41	6	18	3	3.873	3.486	1.549	0.070	0.063	0.028
TPME687*006#0023	E	680	6.3	41	6	23	3	3.426	3.084	1.370	0.079	0.071	0.032
TPMV687*006#0023	V	680	6.3	41	6	23	3	3.520	3.168	1.408	0.081	0.073	0.032
TPME108M006#0025	E	1000	6.3	63	8	25	3	3.286	2.958	1.315	0.082	0.074	0.033
TPMV108M006#0020	V	1000	6.3	63	8	20	3	3.775	3.397	1.510	0.075	0.068	0.030
10 Volt @ 85°C (7 Volt @ 125°C)													
TPMY107M010#0045	Y	100	10	10	8	45	3	2.160	1.944	0.864	0.097	0.087	0.039
TPMY157M010#0045	Y	150	10	15	8	45	3	2.160	1.944	0.864	0.097	0.087	0.039
TPMD227*010#0035	D	220	10	22	8	35	3	2.699	2.429	1.080	0.094	0.085	0.038
TPMD337*010#0035	D	330	10	33	8	35	3	2.699	2.429	1.080	0.094	0.085	0.038
TPME337*010#0023	E	330	10	33	6	23	3	3.426	3.084	1.370	0.079	0.071	0.032
TPME337*010#0035	E	330	10	33	6	35	3	2.777	2.500	1.111	0.097	0.087	0.039
TPME477*010#0023	E	470	10	47	6	23	3	3.426	3.084	1.370	0.079	0.071	0.032
TPME477*010#0030	E	470	10	47	6	30	3	3.000	2.700	1.200	0.090	0.081	0.036
16 Volt @ 85°C (10 Volt @ 125°C)													
TPMD686*016#0040	D	68	16	10.9	8	40	3	2.525	2.272	1.010	0.101	0.091	0.040
TPMD686*016#0050	D	68	16	10.9	8	50	3	2.258	2.032	0.903	0.113	0.102	0.045
TPMD107*016#0040	D	100	16	16	8	40	3	2.525	2.272	1.010	0.101	0.091	0.040
TPMD107*016#0050	D	100	16	16	8	50	3	2.258	2.032	0.903	0.113	0.102	0.045
TPME157*016#0030	E	150	16	24	6	30	3	3.000	2.700	1.200	0.090	0.081	0.036
TPME157*016#0040	E	150	16	24	6	40	3	2.598	2.338	1.039	0.104	0.094	0.042
TPME227*016#0025	E	220	16	35	6	25	3	3.286	2.958	1.315	0.082	0.074	0.033
TPME227*016#0040	E	220	16	35	6	40	3	2.598	2.338	1.039	0.104	0.094	0.042
TPME337*016#0050	E	330	16	52.8	10	50	3	2.324	2.091	0.930	0.116	0.105	0.046
20 Volt @ 85°C (13 Volt @ 125°C)													
TPMD476*020#0045	D	47	20	9.4	8	45	3	2.380	2.142	0.952	0.107	0.096	0.043
TPMD476*020#0055	D	47	20	9.4	8	55	3	2.153	1.938	0.861	0.118	0.107	0.047
TPME107*020#0035	E	100	20	20	6	35	3	2.777	2.500	1.111	0.097	0.087	0.039
TPME107*020#0045	E	100	20	20	6	45	3	2.449	2.205	0.980	0.110	0.099	0.044
TPME157*020#0035	E	150	20	30	10	35	3	2.777	2.500	1.111	0.097	0.087	0.039
25 Volt @ 85°C (17 Volt @ 125°C)													
TPMD336*025#0065	D	33	25	8.3	8	65	3	1.981	1.783	0.792	0.129	0.116	0.051
TPMD476*025#0055	D	47	25	11.8	8	55	3	2.153	1.938	0.861	0.118	0.107	0.047
TPME476*025#0065	E	47	25	11.8	6	65	3	2.038	1.834	0.815	0.132	0.119	0.053
TPME686*025#0045	E	68	25	17	6	45	3	2.449	2.205	0.980	0.110	0.099	0.044
TPME686*025#0055	E	68	25	17	6	55	3	2.216	1.994	0.886	0.122	0.110	0.049
35 Volt @ 85°C (23 Volt @ 125°C)													
TPMD226*035#0070	D	22	35	7.7	8	70	3	1.909	1.718	0.763	0.134	0.120	0.053
TPME226*035#0060	E	22	35	8	6	60	3	2.121	1.909	0.849	0.127	0.115	0.051
TPME226*035#0100	E	22	35	8	6	100	3	1.643	1.479	0.657	0.164	0.148	0.066
TPME336*035#0050	E	33	35	12	6	50	3	2.324	2.091	0.930	0.116	0.105	0.046
TPME336*035#0065	E	33	35	12	6	65	3	2.038	1.834	0.815	0.132	0.119	0.053
TPME476*035#0055	E	47	35	16	6	55	3	2.216	1.994	0.886	0.122	0.110	0.049
TPME476*035#0065	E	47	35	16	6	65	3	2.038	1.834	0.815	0.132	0.119	0.053
50 Volt @ 85°C (33 Volt @ 125°C)													
TPMD106*050#0140	D	10	50	5	8	140	3	1.350	1.215	0.540	0.189	0.170	0.076
TPME106*050#0120	E	10	50	5	6	120	3	1.500	1.350	0.600	0.180	0.162	0.072
TPME156*050#0075	E	15	50	7.5	6	75	3	1.897	1.708	0.759	0.142	0.128	0.057
TPME156*050#0100	E	15	50	7.5	6	100	3	1.643	1.479	0.657	0.164	0.148	0.066
TPME226*050#0075	E	22	50	11	8	75	3	1.897	1.708	0.759	0.142	0.128	0.057
TPME226*050#0100	E	22	50	11	8	100	3	1.643	1.479	0.657	0.164	0.148	0.066

Moisture Sensitivity Level (MSL) is defined according to J-STD-020.
 All technical data relates to an ambient temperature of +25°C. Capacitance and DF are measured at 120Hz, 0.5V RMS with a maximum DC bias of 2.2 volts.
 DCL is measured at rated voltage after 5 minutes.

The EIA & CECC standards for low ESR Solid Tantalum Capacitors allow an ESR movement to 1.25 times catalogue limit post mounting.

For typical weight and composition see page 144.

NOTE: AVX reserves the right to supply a higher voltage rating or tighter tolerance part in the same case size, to the same reliability standards.



TPC Series



Low ESR TACmicrochip®

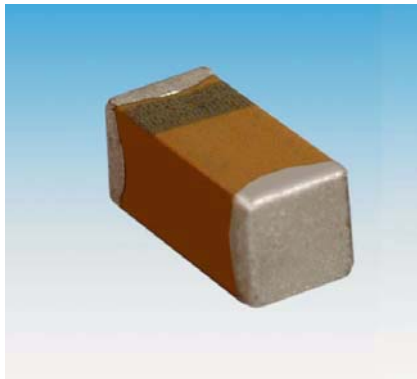

- Low ESR TACmicrochip® capacitor
- Smallest and low profile tantalum
- CV range: 1.0-100µF / 3-25V
- 4 case sizes available
- Power supply applications



CASE DIMENSIONS: millimeters (inches)

Code	EIA Code	EIA Metric	L+0.20 (0.008) -0.00 (0.000)	W+0.15 (0.008) -0.00 (0.000)	H+0.15 (0.008) -0.00 (0.000)	Termination Spacing(S)	Minimum Termination Length (Lt)
H	0805	2012-10	2.00 (0.079)	1.35 (0.053)	1.00 (0.039) max	0.70 (0.028) min	0.15 (0.006)
K	0402	1005-07	1.00 (0.039)	0.50 ^{+0.20} _{-0.00} (0.020 -0.000)	0.50 ^{+0.20} _{-0.00} (0.020 -0.000)	0.40 (0.016) min	0.10 (0.004)
L	0603	1608-10	1.60 (0.063)	0.85 (0.033)	0.85 (0.033)	0.55 (0.022) min	0.15 (0.006)
R	0805	2012-15	2.00 (0.079)	1.35 (0.053)	1.35 (0.053)	0.70 (0.028) min	0.15 (0.006)

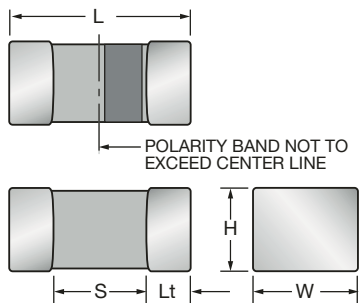

HOW TO ORDER

TPC	R	106	M	010	R	1800
Type TACmicrochip®	Case Size See table above	Capacitance Code pF code: 1st two digits represent significant figures, 3rd digit represents multiplier (number of zeros to follow)	Tolerance K=±10% M=±20%	Rated DC Voltage 003=3Vdc 004=4Vdc 006=6.3Vdc 010=10Vdc 016=16Vdc 020=20Vdc 025=25Vdc	Packaging R, P = 7" Standard Tin Termination Plastic Tape X, Q = 4 1/4" Standard Tin Termination Plastic Tape A, M = 7" Gold Termination Plastic Tape F, N = 4 1/4" Gold Termination Plastic Tape	ESR in mΩ

TECHNICAL SPECIFICATIONS

Technical Data:	All technical data relate to an ambient temperature of +25°C								
Capacitance Range:	1.0 µF to 100 µF								
Capacitance Tolerance:	±10%; ±20%								
Leakage Current DCL:	0.01CV or 0.5µA whichever is the greater								
Rated Voltage (V _R)	≤ +85°C:	3	4	6.3	10	16	20	25	
Category Voltage (V _C)	≤ +125°C:	2	2.7	4	7	10	13	17	
Surge Voltage (V _S)	≤ +85°C:	3.9	5.2	8	13	20	26	32	
Surge Voltage (V _S)	≤ +125°C:	2.6	3.2	5	8	12	16	20	
Temperature Range:	-55°C to +125°C								
Reliability:	1% per 1000 hours at 85°C, V _R with 0.1Ω/V series impedance, 60% confidence level								
Termination Finish:	Nickel and Tin Plating (standard), Nickel and Gold Plating option available upon request								



TPC Series



Low ESR TACmicrochip®

LOW ESR RANGE (LETTER DENOTES CASE SIZE)

Capacitance		Voltage Rating DC (V _R) at 85°C						
µF	Code	3.0V	4.0V	6.3V	10V	16V	20V	25V
1.0	105				L(5000)			R(3000)
1.5	155							
2.2	225			K(8000)/L(5000)	L(5000)	L(5000)		
3.3	335				L(5000)			
4.7	475	K(8000)			L(5000) ^(M)		R(1500) ^{(M)*}	
6.8	685							
10	106			L(4000) ^(M)	H(2500) L(4000) ^(M) ,R(1800)	R(1800)		
15	156			R(1800)	R(1500)			
22	226		L(5000) ^(M) /R(1800)	R(1500)	R(1500)			
33	336	R(1800)	H(1500) ^(M) /R(1500)		R(1500) ^(M)			
47	476	R(1500)		R(1800) ^(M)				
68	686							
100	107		R(1000) ^(M)					

Codes shown are examples of ESR values offered on certain CV and case size. Other codes and ESR values available upon request.

Released codes ^(M tolerance only)

*Code under development – subject to change

Note: Voltage ratings are minimum values. AVX reserves the right to supply higher ratings in the same case size, to the same reliability standards

RATINGS & PART NUMBER REFERENCE

AVX Part No.	EIA	Case Size	Cap (µF)	Rated Voltage (V)	DCL (µA) Max.	DF % Max.	ESR Max. (mΩ) @100kHz	MSL	100kHz Ripple Current Ratings (A)			100kHz Ripple Voltage Ratings (V)		
									25°C	85°C	125°C	25°C	85°C	125°C
3 Volt @ 85°C (2 Volt @ 125°C)														
TPCK475*003#8000	0402	K	4.7	3	0.5	12	8000	1	0.043	0.039	0.017	0.346	0.312	0.139
TPCR336*003#1800	0805	R	33	3	1.0	10	1800	1	0.158	0.142	0.063	0.285	0.256	0.114
TPCR476*003#1500	0805	R	47	3	1.5	10	1500	1	0.173	0.156	0.069	0.260	0.234	0.104
4 Volt @ 85°C (2.7 Volt @ 125°C)														
TPCL226M004#5000	0603	L	22	4	0.9	6	5000	1	0.071	0.064	0.028	0.354	0.318	0.141
TPCR226*004#1800	0805	R	22	4	0.9	8	1800	1	0.158	0.142	0.063	0.285	0.256	0.114
TPCH336M004#1500	0805	H	33	4	1.3	14	1500	1	0.163	0.147	0.065	0.245	0.221	0.098
TPCR336*004#1500	0805	R	33	4	1.3	10	1500	1	0.173	0.156	0.069	0.260	0.234	0.104
TPCR107M004#1000	0805	R	100	4	4.0	30	1000	1	0.212	0.191	0.085	0.212	0.191	0.085
6.3 Volt @ 85°C (4 Volt @ 125°C)														
TPCK225*006#8000	0402	K	2.2	6.3	0.5	8	8000	1	0.043	0.039	0.017	0.346	0.312	0.139
TPCL225*006#5000	0603	L	2.2	6.3	0.5	6	5000	1	0.071	0.064	0.028	0.354	0.318	0.141
TPCL106M006#4000	0603	L	10	6.3	0.6	10	4000	1	0.079	0.071	0.032	0.316	0.285	0.126
TPCR156*006#1800	0805	R	15	6.3	0.9	8	1800	1	0.158	0.142	0.063	0.285	0.256	0.114
TPCR226*006#1500	0805	R	22	6.3	1.4	10	1500	1	0.173	0.156	0.069	0.260	0.234	0.104
TPCR476M006#1800	0805	R	47	6.3	3.0	20	1800	1	0.158	0.142	0.063	0.285	0.256	0.114
10 Volt @ 85°C (7 Volt @ 125°C)														
TPCL105*010#5000	0603	L	1.0	10	0.5	6	5000	1	0.071	0.064	0.028	0.354	0.318	0.141
TPCL225*010#5000	0603	L	2.2	10	0.5	6	5000	1	0.071	0.064	0.028	0.354	0.318	0.141
TPCL335*010#5000	0603	L	3.3	10	0.5	8	5000	1	0.071	0.064	0.028	0.354	0.318	0.141
TPCL475M010#5000	0603	L	4.7	10	0.5	10	5000	1	0.071	0.064	0.028	0.354	0.318	0.141
TPCH106*010#2500	0805	H	10	10	1.0	8	2500	1	0.126	0.113	0.050	0.100	0.09	0.040
TPCL106M010#4000	0603	L	10	10	1.0	20	4000	1	0.079	0.071	0.032	0.316	0.285	0.126
TPCR106*010#1800	0805	R	10	10	1.0	8	1800	1	0.158	0.142	0.063	0.285	0.256	0.114
TPCR156*010#1500	0805	R	15	10	1.5	10	1500	1	0.173	0.156	0.069	0.260	0.234	0.104
TPCR226*010#1500	0805	R	22	10	2.2	14	1500	1	0.173	0.156	0.069	0.260	0.234	0.104
TPCR336M010#1500	0805	R	33	10	3.3	20	1500	1	0.173	0.156	0.069	0.260	0.234	0.104
16 Volt @ 85°C (10 Volt @ 125°C)														
TPCL225*016#5000	0603	L	2.2	16	0.5	10	5000	1	0.071	0.064	0.028	0.354	0.318	0.141
TPCR106*016#1800	0805	R	10	16	1.6	10	1800	1	0.158	0.142	0.063	0.285	0.256	0.114
20 Volt @ 85°C (13 Volt @ 125°C)														
TPCR475M020#1500	0805	R	4.7	20	0.9	8	1500	1	0.173	0.156	0.069	0.260	0.234	0.104
25 Volt @ 85°C (17 Volt @ 125°C)														
TPCR105*025#3000	0805	R	1.0	25	0.5	8	3000	1	0.122	0.110	0.049	0.367	0.331	0.147

Moisture Sensitivity Level (MSL) is defined according to J-STD-020.

All technical data relates to an ambient temperature of +25°C. Capacitance and DF are measured at 120Hz, 0.5V RMS with a maximum DC bias of 2.2 volts. DCL is measured at rated voltage after 5 minutes.

The EIA & CECC standards for low ESR Solid Tantalum Capacitors allow an ESR movement to 1.25 times catalogue limit post mounting.

For typical weight and composition see page 144.

NOTE: AVX reserves the right to supply a higher voltage rating or tighter tolerance part in the same case size, to the same reliability standards.

TCJ Series



Tantalum Solid Electrolytic Chip Capacitors with Conductive Polymer Electrode

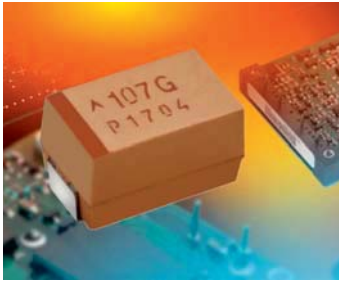

- Conductive polymer electrode reduces ignition failure mode
- Lower ESR
- 3x reflow 260°C compatible
- CV range: 0.47-470µF / 2.5-125V
- 16 case sizes available



Elektra Award 2010



LEAD-FREE
LEAD-FREE COMPATIBLE
COMPONENT



RoHS
COMPLIANT

CASE DIMENSIONS: millimeters (inches)

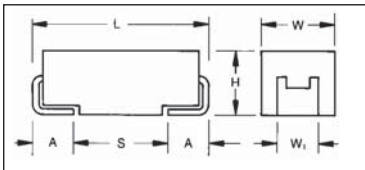

For part marking see page 151

Code	EIA Code	EIA Metric	L±0.20 (0.008)	W±0.20 (0.008) -0.10 (0.004)	H±0.20 (0.008) -0.10 (0.004)	W ₁ ±0.20 (0.008)	A±0.30 (0.012) -0.20 (0.008)	S Min.
A	1206	3216-18	3.20 (0.126)	1.60 (0.063)	1.60 (0.063)	1.20 (0.047)	0.80 (0.031)	1.10 (0.043)
B	1210	3528-21	3.50 (0.138)	2.80 (0.110)	1.90 (0.075)	2.20 (0.087)	0.80 (0.031)	1.40 (0.055)
C	2312	6032-28	6.00 (0.236)	3.20 (0.126)	2.60 (0.102)	2.20 (0.087)	1.30 (0.051)	2.90 (0.114)
D	2917	7343-31	7.30 (0.287)	4.30 (0.169)	2.90 (0.114)	2.40 (0.094)	1.30 (0.051)	4.40 (0.173)
E	2917	7343-43	7.30 (0.287)	4.30 (0.169)	4.10 (0.162)	2.40 (0.094)	1.30 (0.051)	4.40 (0.173)
G	1206	3216-15	3.20 (0.126)	1.60 (0.063)	1.50 (0.059) max	1.20 (0.047)	0.80 (0.031)	1.10 (0.043)
H	1210	3528-15	3.50 (0.138)	2.80 (0.110)	1.50 (0.059) max	2.20 (0.087)	0.80 (0.031)	1.40 (0.055)
K	1206	3216-10	3.20 (0.126)	1.60 (0.063)	1.00 (0.039) max	1.20 (0.047)	0.80 (0.031)	1.10 (0.043)
N	0805	2012-10	2.05 (0.081)	1.30 (0.051)	1.00 (0.039) max	1.00 (0.039)	0.50 (0.020)	0.85 (0.033)
P	0805	2012-15	2.05 (0.081)	1.35 (0.050)	1.50 (0.059) max	1.00±0.10 (0.039±0.004)	0.50 (0.020)	0.85 (0.033)
R	0805	2012-12	2.05 (0.081)	1.30 (0.051)	1.20 (0.047) max	1.00±0.10 (0.039±0.004)	0.50 (0.020)	0.85 (0.033)
S	1206	3216-12	3.20 (0.126)	1.60 (0.063)	1.20 (0.047) max	1.20 (0.047)	0.80 (0.031)	1.10 (0.043)
T	1210	3528-12	3.50 (0.138)	2.80 (0.110)	1.20 (0.047) max	2.20 (0.087)	0.80 (0.031)	1.40 (0.055)
V	2924	7361-38	7.30 (0.287)	6.10 (0.240)	3.55 (0.140)	3.10 (0.120)	1.30 (0.051)	4.40 (0.173)
W	2312	6032-15	6.00 (0.236)	3.20 (0.126)	1.50 (0.059) max	2.20 (0.087)	1.30 (0.051)	2.90 (0.114)
Y	2917	7343-20	7.30 (0.287)	4.30 (0.169)	2.00 (0.079) max	2.40 (0.094)	1.30 (0.051)	4.40 (0.173)

W1 dimension applies to the termination width for A dimensional area only.

HOW TO ORDER

TCJ

Type

A

Case Size
See table above

226

Capacitance Code
pF code: 1st two digits represent significant figures, 3rd digit represents multiplier (number of zeros to follow)

M

Tolerance
M=±20%

004

Rated DC Voltage
002=2.5Vdc
004=4Vdc
006=6.3Vdc
010=10Vdc
016=16Vdc
020=20Vdc
025=25Vdc
035=35Vdc
050=50Vdc
063=63Vdc
075=75Vdc
100=100Vdc
125=125Vdc

R

Packaging
R = Pure Tin 7" Reel
S = Pure Tin 13" Reel

0300

ESR in mΩ

TECHNICAL SPECIFICATIONS

Technical Data:

All technical data relate to an ambient temperature of +25°C

Capacitance Range: 0.47 µF to 470 µF

Capacitance Tolerance: ±20%

Leakage Current DCL: 0.1CV

Rated Voltage (V _R)	≤ +85°C:	2.5	4	6.3	10	16	2.5	4	6.3	10	16	20	25	35	50	63	75	100	125
Category Voltage (V _C)	≤ +105°C:						2	3.2	5	8	12.8	16	20	28	40	50.4	60	80	100
Category Voltage (V _C)	≤ +125°C:	1.7	2.7	4	7	10													
Surge Voltage (V _S)	≤ +85°C:	3.3	5.2	8	13	20	3.25	5.2	8	13	20.8	26	33	46	65	81.9	97.5	130	162.5
Surge Voltage (V _S)	≤ +105°C:						2.5	4	6	10	16	20	25	35	50	63	75	100	125
Surge Voltage (V _S)	≤ +125°C:	2.2	3.4	5	8	13													

Temperature Range: -55°C to +125°C, -55°C to +105°C

Reliability: 1% per 1000 hours at 85°C, V_R with 0.1Ω/V series impedance, 60% confidence level



TCJ Series



Tantalum Solid Electrolytic Chip Capacitors with Conductive Polymer Electrode

CAPACITANCE AND RATED VOLTAGE, VR (VOLTAGE CODE) RANGE (LETTER DENOTES CASE SIZE)

125°C RATED PARTS

Capacitance		Rated Voltage DC (V _R) to 85°C				
µF	Code	2.5V (e)	4V (G)	6.3V (J)	10V (A)	16V (C)
1.0	105					
4.7	475				K(500), R(500)	
6.8	685					A(200)
10	106			A(300), R(500)	A(300)	A(200), B(200), T(150,200)
15	156		A(300)	A(300)	A(200)	B(150)
22	226		A(300)	A(300), K(400) R(500), S(400), T(150)	B(300), T(150)	B(150)
33	336		A(300)	A(200) B(70,200) C(100) T(150)	B(70,200) C(100) T(70,150)	
47	476		A(200), T(80)	A(200), B(70) K(400), P(500) T(80,120)	B(70), C(100)	
68	686	A(250)	A(250), B(70) T(80)	B(55,70) C(100), W(70)		
100	107	A(200), B(70)	A(200), B(70) G(300), T(150)	B(45,69,70)		
150	157	B(70)	B(70)	B(45,69,70) H(200), W(40,70)		
220	227		B(45,70)	B(70,200)		

105°C RATED PARTS

Cap		Rated Voltage DC (V _R) to 85°C												
µF	Code	2.5V (e)	4V (G)	6.3V (J)	10V (A)	16V (C)	20V (D)	25V (E)	35V (V)	50V (T)	63V (J)	75V (P)	100V (A)	125V (B)
0.47	474										B(400)			
0.68	684									B(400)	B(300)			
1.0	105							N*, P(500)	A(250)*	A*, B(300)	B(300), C(300)			
1.5	155								B(200)	B(300), C(300)	C(300)			
2.2	225								B(200)	C(300)	C(200)			
3.3	335								B(200)	C(200)	C(200)			D(250)
4.7	475							B(150)	B(200), C(200)	C(200)	C(200), D(120)	D(150)		
6.8	685							B(150)	C(200)	C(200), D(120)	D(120), E(100,150)	D(120)	V(250)	
10	106			N(200*,500)				B(150)	B(200), C(200), Y(70)	D(120), E(70,100)	E(100,150)			
15	156							B(100,150), Y(70,200)*	C(200), D(70,100), W*, Y(200)*	E(70,100)				
22	226			N(500)			Y(70)	B(150), C(100), D(60,100), Y(70)	D(70,100), Y(70)*					
33	336					Y(60,70)	Y(70)	D(60,100), Y(70,100)	D(70,100), E(55,70)					
47	476			K(150,200), R(500), T(70)		Y(45,70)	D(55)*, Y(70)	D(60,100), E(50)	E(55)					
68	686			T(200)		D(45,55) Y(45,55)	D(55), E(45)	E(50)						
100	107			A(70)*, T(200)	D(45,55), Y(45,55)	E(40)	D(55), E(45)	E(80)						
150	157			B(35), Y(40)	D(45,55), Y(45,55)	E(40)								
220	227	A(35)*	B(60)	D(40,50) W(100)*, Y(50)	D(40,50), Y(40,50)									
330	337		D(50), Y(50)	D(40,50) Y(40,50)										
470	477	D(50), Y(50)	D(50) Y(50)											

Available Ratings, (ESR ratings in mOhms in brackets)

Engineering samples - please contact manufacturer

*Codes under development - subject to change

Note: Voltage ratings are minimum values. AVX reserves the right to supply higher ratings in the same case size, to the same reliability standards.

TCJ Series



Tantalum Solid Electrolytic Chip Capacitors with Conductive Polymer Electrode

RATINGS & PART NUMBER REFERENCE

AVX Part No.	Case Size	Capacitance (µF)	Rated Voltage (V)	DCL (µA) Max.	DF % Max.	ESR Max. (mΩ) @100kHz	MSL	100kHz RMS Current (mA)			100kHz RMS Voltage (mV)		
								25°C	85°C	125°C	25°C	85°C	125°C
2.5 Volt @ 85°C (1.7 Volt @ 125°C)													
TCJA686M002#0250	A	68	2.5	17.0	6	250	3	548	493	219	137	123	55
TCJA107M002#0200	A	100	2.5	25.0	6	200	3	612	551	245	122	110	49
TCJB107M002#0070	B	100	2.5	25.0	6	70	3	1102	992	441	77	69	31
TCJB157M002#0070	B	150	2.5	37.5	6	70	3	1102	992	441	77	69	31
4 Volt @ 85°C (2.7 Volt @ 125°C)													
TCJA156M004#0300	A	15	4	6.0	6	300	3	500	450	200	150	135	60
TCJA226M004#0300	A	22	4	8.8	6	300	3	500	450	200	150	135	60
TCJA336M004#0300	A	33	4	13.2	6	300	3	500	450	200	150	135	60
TCJA476M004#0200	A	47	4	18.8	6	200	3	612	551	245	122	110	49
TCJT476M004#0080	T	47	4	18.8	8	80	3	1000	900	400	80	72	32
TCJA686M004#0250	A	68	4	27.2	6	250	3	548	493	219	137	123	55
TCJB686M004#0070	B	68	4	27.2	6	70	3	1102	992	441	77	69	31
TCJT686M004#0080	T	68	4	27.2	8	80	3	1000	900	400	80	72	32
TCJA107M004#0200	A	100	4	40.0	6	200	3	612	551	245	122	110	49
TCJB107M004#0070	B	100	4	40.0	8	70	3	1102	992	441	77	69	31
TCJG107M004#0300	G	100	4	40.0	10	300	3	483	435	193	145	130	58
TCJT107M004#0150	T	100	4	40.0	8	150	3	730	657	292	110	99	44
TCJB157M004#0070	B	150	4	60.0	6	70	3	1102	992	441	77	69	31
TCJB227M004#0045	B	220	4	88.0	10	45	3	1374	1237	550	62	56	25
TCJB227M004#0070	B	220	4	88.0	10	70	3	1102	992	441	77	69	31
6.3 Volt @ 85°C (4 Volt @ 125°C)													
TCJA106M006#0300	A	10	6.3	6.0	6	300	3	500	450	200	150	135	60
TCJR106M006#0500	R	10	6.3	6.0	6	500	3	332	298	133	166	149	66
TCJA156M006#0300	A	15	6.3	9.0	6	300	3	500	450	200	150	135	60
TCJA226M006#0300	A	22	6.3	13.2	6	300	3	500	450	200	150	135	60
TCJK226M006#0400	K	22	6.3	13.2	8	400	3	403	363	161	161	145	64
TCJR226M006#0500	R	22	6.3	13.2	10	500	3	332	298	133	166	149	66
TCJS226M006#0400	S	22	6.3	13.2	8	400	3	403	363	161	161	145	64
TCJT226M006#0150	T	22	6.3	13.2	6	150	3	730	657	292	110	99	44
TCJA336M006#0200	A	33	6.3	19.8	6	200	3	612	551	245	122	110	49
TCJB336M006#0070	B	33	6.3	19.8	6	70	3	1102	992	441	77	69	31
TCJB336M006#0200	B	33	6.3	19.8	6	200	3	652	587	261	130	117	52
TCJT336M006#0150	T	33	6.3	19.8	8	150	3	730	657	292	110	99	44
TCJA476M006#0200	A	47	6.3	28.2	6	200	3	612	551	245	122	110	49
TCJB476M006#0070	B	47	6.3	28.2	6	70	3	1102	992	441	77	69	31
TCJK476M006#0400	K	47	6.3	28.2	6	400	3	403	363	161	161	146	64
TCJP476M006#0500	P	47	6.3	28.2	10	500	3	346	312	139	173	156	69
TCJT476M006#0080	T	47	6.3	28.2	8	80	3	1000	900	400	80	72	32
TCJT476M006#0120	T	47	6.3	28.2	8	120	3	816	735	327	98	88	39
TCJB686M006#0055	B	68	6.3	40.8	8	55	3	1243	1119	497	68	62	27
TCJB686M006#0070	B	68	6.3	40.8	8	70	3	1102	992	441	77	69	31
TCJC686M006#0100	C	68	6.3	40.8	6	100	3	1049	944	420	105	94	42
TCJW686M006#0070	W	68	6.3	40.8	8	70	3	1134	1021	454	79	71	32
TCJB107M006#0045	B	100	6.3	60.0	10	45	3	1374	1237	550	62	56	25
TCJB107M006#0069	B	100	6.3	60.0	10	69	3	1110	999	444	77	69	31
TCJB107M006#0070	B	100	6.3	60.0	10	70	3	1102	992	441	77	69	31
TCJB157M006#0045	B	150	6.3	90.0	10	45	3	1374	1237	550	62	56	25
TCJB157M006#0069	B	150	6.3	90.0	10	69	3	1110	999	444	77	69	31
TCJB157M006#0070	B	150	6.3	90.0	10	70	3	1102	992	441	77	69	31
TCJH157M006#0200	H	150	6.3	90.0	6	200	3	632	569	253	126	114	51
TCJW157M006#0040	W	150	6.3	90.0	6	40	3	1500	1350	600	60	54	24
TCJW157M006#0070	W	150	6.3	90.0	6	70	3	1134	1021	454	79	71	32
TCJB227M006#0070	B	220	6.3	132.0	10	70	3	1102	992	441	77	69	31
TCJB227M006#0200	B	220	6.3	132.0	10	200	3	652	587	261	130	117	52
10 Volt @ 85°C (7 Volt @ 125°C)													
TCJK475M010#0500	K	4.7	10	4.7	6	500	3	361	324	144	180	162	72
TCJR475M010#0500	R	4.7	10	4.7	6	500	3	332	298	133	166	149	66
TCJA106M010#0300	A	10	10	10.0	6	300	3	500	450	200	150	135	60
TCJA156M010#0200	A	15	10	15.0	6	200	3	612	551	245	122	110	49

Moisture Sensitivity Level (MSL) is defined according to J-STD-020.

All technical data relates to an ambient temperature of +25°C. Capacitance and DF are measured at 120Hz, 0.5RMS with DC bias of 2.2 volts. DCL is measured at rated voltage after 5 minutes.

ESR allowed to move up to 1.25 times catalog limit post mounting.

For typical weight and composition see page 144.

NOTE: AVX reserves the right to supply a higher voltage rating or tighter tolerance part in the same case size, to the same reliability standards.



TCJ Series



Tantalum Solid Electrolytic Chip Capacitors with Conductive Polymer Electrode

RATINGS & PART NUMBER REFERENCE

AVX Part No.	Case Size	Capacitance (µF)	Rated Voltage (V)	DCL (µA) Max.	DF % Max.	ESR Max. (mΩ) @100kHz	MSL	100kHz RMS Current (mA)			100kHz RMS Voltage (mV)		
								25°C	85°C	125°C	25°C	85°C	125°C
TCJB226M010#0300	B	22	10	22.0	6	300	3	532	479	213	160	144	64
TCJT226M010#0150	T	22	10	22.0	6	150	3	730	657	292	110	99	44
TCJB336M010#0070	B	33	10	33.0	6	70	3	1102	992	441	77	69	31
TCJB336M010#0200	B	33	10	33.0	6	200	3	652	587	261	130	117	52
TCJC336M010#0100	C	33	10	33.0	6	100	3	1049	944	420	105	94	42
TCJT336M010#0070	T	33	10	33.0	6	70	3	1069	962	428	75	67	30
TCJT336M010#0150	T	33	10	33.0	6	150	3	730	657	292	110	99	44
TCJB476M010#0070	B	47	10	47.0	6	70	3	1102	992	441	77	69	31
TCJC476M010#0100	C	47	10	47.0	6	100	3	1049	944	420	105	94	42
16 Volt @ 85°C (10 Volt @ 125°C)													
TCJA685M016#0200	A	6.8	16	10.9	6	200	3	612	551	245	122	110	49
TCJA106M016#0200	A	10	16	16.0	6	200	3	612	551	245	122	110	49
TCJB106M016#0200	B	10	16	16.0	6	200	3	652	587	261	130	117	52
TCJT106M016#0150	T	10	16	16.0	6	150	3	730	657	292	110	99	44
TCJT106M016#0200	T	10	16	16.0	6	200	3	632	569	253	126	114	51
TCJB156M016#0150	B	15	16	24.0	6	150	3	758	677	301	113	102	45
TCJB226M016#0150	B	22	16	35.2	6	150	3	753	677	301	113	102	45

Moisture Sensitivity Level (MSL) is defined according to J-STD-020.

All technical data relates to an ambient temperature of +25°C. Capacitance and DF are measured at 120Hz, 0.5RMS with DC bias of 2.2 volts. DCL is measured at rated voltage after 5 minutes.

ESR allowed to move up to 1.25 times catalog limit post mounting.

For typical weight and composition see page 144.

NOTE: AVX reserves the right to supply a higher voltage rating or tighter tolerance part in the same case size, to the same reliability standards.

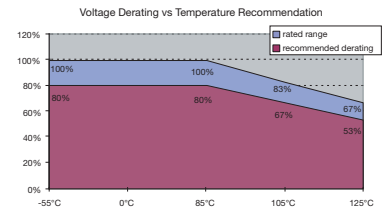

AVX Part No.	Case Size	Capacitance (µF)	Rated Voltage (V)	DCL (µA) Max.	DF % Max.	ESR Max. (mΩ) @100kHz	MSL	100kHz RMS Current (mA)			100kHz RMS Voltage (mV)		
								25°C	85°C	105°C	25°C	85°C	105°C
2.5 Volt @ 85°C (2 Volt @ 105°C)													
TCJD477M002#0050	D	470	2.5	117.5	6	50	3	1732	1559	1126	87	78	56
TCJY477M002#0050	Y	470	2.5	117.5	6	50	3	1581	1423	1028	79	71	51
4 Volt @ 85°C (3.2 Volt @ 105°C)													
TCJB227M004#0060	B	220	4	88	10	60	3	1190	1071	774	71	64	46
TCJD337M004#0050	D	330	4	132	6	50	3	1732	1559	1126	87	78	56
TCJY337M004#0050	Y	330	4	132	6	50	3	1581	1423	1028	79	71	51
TCJD477M004#0050	D	470	4	188	6	50	3	1732	1559	1126	87	78	56
TCJY477M004#0050	Y	470	4	188	6	50	3	1581	1423	1028	79	71	51
6.3 Volt @ 85°C (5 Volt @ 105°C)													
TCJN106M006#0500	N	10	6.3	6.0	6	500	3	316	285	206	158	142	103
TCJN226M006#0500	N	22	6.3	13.2	10	500	3	316	285	206	158	142	103
TCJK476M006#0150	K	47	6.3	28.2	6	150	3	658	592	428	99	89	64
TCJK476M006#0200	K	47	6.3	28.2	6	200	3	570	513	371	114	103	74
TCJR476M006#0500	R	47	6.3	28.2	10	500	3	332	298	216	166	149	108
TCJT476M006#0070	T	47	6.3	28.2	8	70	3	1069	962	695	75	67	49
TCJT686M006#0200	T	68	6.3	40.8	8	200	3	632	569	411	126	114	82
TCJT107M006#0200	T	100	6.3	60	10	200	3	632	569	411	126	114	82
TCJB157M006#0035	B	150	6.3	90	10	35	3	1558	1403	1013	55	49	35
TCJY157M006#0040	Y	150	6.3	90	6	40	3	1768	1591	1149	71	64	46
TCJD227M006#0040	D	220	6.3	132	6	40	3	1936	1743	1259	77	70	50
TCJD227M006#0050	D	220	6.3	132	6	50	3	1732	1559	1126	87	78	56
TCJY227M006#0050	Y	220	6.3	132	6	50	3	1581	1423	1028	79	71	51
TCJD337M006#0040	D	330	6.3	198	6	40	3	1936	1743	1259	77	70	50
TCJD337M006#0050	D	330	6.3	198	6	50	3	1732	1559	1126	87	78	56
TCJY337M006#0040	Y	330	6.3	198	12	40	3	1768	1591	1149	71	64	46
TCJY337M006#0050	Y	330	6.3	198	12	50	3	1581	1423	1028	79	71	51
10 Volt @ 85°C (8 Volt @ 105°C)													
TCJD107M010#0045	D	100	10	100	6	45	3	1826	1643	1187	82	74	53
TCJD107M010#0055	D	100	10	100	6	55	3	1651	1486	1073	91	82	59
TCJY107M010#0045	Y	100	10	100	6	45	3	1667	1500	1083	75	68	49
TCJY107M010#0055	Y	100	10	100	6	55	3	1508	1357	980	83	75	54
TCJD157M010#0045	D	150	10	150	6	45	3	1826	1643	1187	82	74	53
TCJD157M010#0055	D	150	10	150	6	55	3	1651	1486	1073	91	82	59
TCJY157M010#0045	Y	150	10	150	6	45	3	1667	1500	1083	75	68	49
TCJY157M010#0055	Y	150	10	150	6	55	3	1508	1357	980	83	75	54
TCJD227M010#0040	D	220	10	220	6	40	3	1936	1743	1259	77	70	50
TCJD227M010#0050	D	220	10	220	6	50	3	1732	1559	1126	87	78	56
TCJY227M010#0040	Y	220	10	220	6	40	3	1768	1591	1149	71	64	46
TCJY227M010#0050	Y	220	10	220	6	50	3	1581	1423	1028	79	71	51



TCJ Series



Tantalum Solid Electrolytic Chip Capacitors with Conductive Polymer Electrode

RATINGS & PART NUMBER REFERENCE

AVX Part No.	Case Size	Capacitance (µF)	Rated Voltage (V)	DCL (µA) Max.	DF % Max.	ESR Max. (mΩ) @100kHz	MSL	100kHz RMS Current (mA)			100kHz RMS Voltage (mV)		
								25°C	85°C	105°C	25°C	85°C	105°C
16 Volt @ 85°C (12.8 Volt @ 105°C)													
TCJY336M016#0060	Y	33	16	52.8	6	60	3	1443	1299	938	87	78	56
TCJY336M016#0070	Y	33	16	52.8	6	70	3	1336	1203	869	94	84	61
TCJY476M016#0045	Y	47	16	75.2	6	45	3	1667	1500	1083	75	68	49
TCJY476M016#0070	Y	47	16	75.2	6	70	3	1336	1203	869	94	84	61
TCJD686M016#0045	D	68	16	108.8	6	45	3	1826	1643	1187	82	74	53
TCJD686M016#0055	D	68	16	108.8	6	55	3	1651	1486	1073	91	82	59
TCJY686M016#0045	Y	68	16	108.8	6	45	3	1667	1500	1083	75	68	49
TCJY686M016#0055	Y	68	16	108.8	6	55	3	1508	1357	980	83	75	54
TCJE107M016#0040	E	100	16	160.0	6	40	3	2031	1828	1320	81	73	53
TCJE157M016#0040	E	150	16	240.0	6	40	3	2031	1828	1320	81	73	53
20 Volt @ 85°C (16 Volt @ 105°C)													
TCJY226M020#0070	Y	22	20	44.0	6	70	3	1336	1203	869	94	84	61
TCJY336M020#0070	Y	33	20	66.0	6	70	3	1336	1203	869	94	84	61
TCJY476M020#0070	Y	47	20	94.0	6	70	3	1336	1203	869	94	84	61
TCJD686M020#0055	D	68	20	136.0	6	55	3	1651	1486	1073	91	82	59
TCJE686M020#0045	E	68	20	136.0	6	45	3	1915	1723	1245	86	78	56
TCJD107M020#0055	D	100	20	200.0	6	55	3	1651	1486	1073	91	82	59
TCJE107M020#0045	E	100	20	200.0	6	45	3	1915	1723	1245	86	78	56
25 Volt @ 85°C (20 Volt @ 105°C)													
TCJP105M025#0500	P	1.0	25	2.5	6	500	3	346	312	225	173	156	113
TCJB475M025#0150	B	4.7	25	11.8	6	150	3	753	677	489	113	102	73
TCJB685M025#0150	B	6.8	25	17.0	6	150	3	753	677	489	113	102	73
TCJB106M025#0150	B	10	25	25.0	6	150	3	753	677	489	113	102	73
TCJB156M025#0100	B	15	25	37.5	6	100	3	922	830	599	92	83	60
TCJB156M025#0150	B	15	25	37.5	6	150	3	753	677	489	113	102	73
TCJB226M025#0150	B	22	25	55.0	6	150	3	753	677	489	113	102	73
TCJC226M025#0100	C	22	25	55.0	6	100	3	1049	944	682	105	94	68
TCJD226M025#0060	D	22	25	55.0	6	60	3	1581	1423	1028	95	85	62
TCJD226M025#0100	D	22	25	55.0	6	100	3	1225	1102	796	122	110	80
TCJY226M025#0070	Y	22	25	55.0	6	70	3	1336	1203	869	94	84	61
TCJD336M025#0060	D	33	25	82.5	6	60	3	1581	1423	1028	95	85	62
TCJD336M025#0100	D	33	25	82.5	6	100	3	1225	1102	796	122	110	80
TCJY336M025#0070	Y	33	25	82.5	6	70	3	1336	1203	869	94	84	61
TCJY336M025#0100	Y	33	25	82.5	6	100	3	1118	1006	727	112	101	73
TCJD476M025#0060	D	47	25	117.5	6	60	3	1581	1423	1028	95	85	62
TCJD476M025#0100	D	47	25	117.5	6	100	3	1225	1102	796	122	110	80
TCJE476M025#0050	E	47	25	117.5	6	50	3	1817	1635	1181	91	82	59
TCJE686M025#0050	E	68	25	170.0	6	50	3	1817	1635	1181	91	82	59
TCJE107M025#0080	E	100	25	250.0	6	80	3	1436	1293	933	115	103	75
35 Volt @ 85°C (28 Volt @ 105°C)													
TCJB155M035#0200	B	1.5	35	5.3	6	200	3	652	587	424	130	117	85
TCJB225M035#0200	B	2.2	35	7.7	6	200	3	652	587	424	130	117	85
TCJB335M035#0200	B	3.3	35	11.6	6	200	3	652	587	424	130	117	85
TCJB475M035#0200	B	4.7	35	16.5	6	200	3	652	587	424	130	117	85
TCJC475M035#0200	C	4.7	35	16.5	6	200	3	742	667	482	148	133	96
TCJC685M035#0200	C	6.8	35	23.8	6	200	3	742	667	482	148	133	96
TCJB106M035#0200	B	10	35	35.0	6	200	3	652	587	424	130	117	85
TCJC106M035#0200	C	10	35	35.0	6	200	3	742	667	482	148	133	96
TCJC156M035#0200	C	15	35	52.5	6	200	3	742	667	482	148	133	96
TCJY106M035#0070	Y	10	35	35.0	6	70	3	1336	1203	869	94	84	61
TCJD156M035#0070	D	15	35	52.5	6	70	3	1464	1317	952	102	92	67
TCJD156M035#0100	D	15	35	52.5	6	100	3	1225	1102	796	122	110	80
TCJD226M035#0070	D	22	35	77.0	6	70	3	1464	1317	952	102	92	67
TCJD226M035#0100	D	22	35	77.0	6	100	3	1225	1102	796	122	110	80
TCJD336M035#0070	D	33	35	115.5	6	70	3	1464	1317	952	102	92	67
TCJD336M035#0100	D	33	35	115.5	6	100	3	1225	1102	796	122	110	80
TCJE336M035#0055	E	33	35	115.5	6	55	3	1732	1559	1126	95	86	62
TCJE336M035#0070	E	33	35	115.5	6	70	3	1535	1382	998	107	97	70
TCJE476M035#0055	E	47	35	164.5	6	55	3	1732	1559	1126	95	86	62

Moisture Sensitivity Level (MSL) is defined according to J-STD-020.

All technical data relates to an ambient temperature of +25°C. Capacitance and DF are measured at 120Hz, 0.5RMS with DC bias of 2.2 volts. DCL is measured at rated voltage after 5 minutes.

ESR allowed to move up to 1.25 times catalog limit post mounting.

For typical weight and composition see page 144.

NOTE: AVX reserves the right to supply a higher voltage rating or tighter tolerance part in the same case size, to the same reliability standards.



TCJ Series



Tantalum Solid Electrolytic Chip Capacitors with Conductive Polymer Electrode

RATINGS & PART NUMBER REFERENCE

AVX Part No.	Case Size	Capacitance (µF)	Rated Voltage (V)	DCL (µA) Max.	DF % Max.	ESR Max. (mΩ) @100kHz	MSL	100kHz RMS Current (mA)			100kHz RMS Voltage (mV)		
								25°C	85°C	105°C	25°C	85°C	105°C
50 Volt @ 85°C (40 Volt @ 105°C)													
TCJB684M050#0400	B	0.68	50	3.4	6	400	3	461	415	300	184	166	120
TCJB105M050#0300	B	1.0	50	5.0	6	300	3	532	479	346	160	144	104
TCJB155M050#0300	B	1.5	50	7.5	6	300	3	532	479	346	160	144	104
TCJC155M050#0300	C	1.5	50	7.5	6	300	3	606	545	394	182	163	118
TCJC225M050#0300	C	2.2	50	11	6	300	3	606	545	394	182	163	118
TCJC335M050#0200	C	3.3	50	16.5	8	200	3	742	667	482	148	133	96
TCJC475M050#0200	C	4.7	50	23.5	8	200	3	742	667	482	148	133	96
TCJC685M050#0200	C	6.8	50	34.0	8	200	3	742	667	482	148	133	96
TCJD685M050#0120	D	6.8	50	34.0	10	120	3	1118	1006	727	134	121	87
TCJD106M050#0120	D	10	50	50.0	10	120	3	1118	1006	727	134	121	87
TCJE106M050#0070	E	10	50	50.0	6	70	3	1535	1382	998	107	97	70
TCJE106M050#0100	E	10	50	50.0	6	100	3	1285	1156	835	128	116	83
TCJE156M050#0070	E	15	50	75.0	6	70	3	1535	1382	998	107	97	70
TCJE156M050#0100	E	15	50	75.0	6	100	3	1285	1156	835	128	116	83
63 Volt @ 85°C (50.4 Volt @ 105°C)													
TCJB474M063#0400	B	0.47	63	3.0	8	400	3	461	415	300	184	166	120
TCJB684M063#0300	B	0.68	63	4.3	8	300	3	532	479	346	160	144	104
TCJB105M063#0300	B	1.0	63	6.3	8	300	3	532	479	346	160	144	104
TCJC105M063#0300	C	1.0	63	6.3	6	300	3	606	545	394	182	163	118
TCJC155M063#0300	C	1.5	63	9.5	6	300	3	606	545	394	182	163	118
TCJC225M063#0200	C	2.2	63	13.9	6	200	3	742	667	482	148	133	96
TCJC335M063#0200	C	3.3	63	20.8	6	200	3	742	667	482	148	133	96
TCJC475M063#0200	C	4.7	63	29.6	6	200	3	742	667	482	148	133	96
TCJD475M063#0120	D	4.7	63	29.6	6	120	3	1118	1006	727	134	121	87
TCJD685M063#0120	D	6.8	63	42.8	6	120	3	1118	1006	727	134	121	87
TCJE685M063#0100	E	6.8	63	42.8	6	100	3	1285	1156	835	128	116	83
TCJE685M063#0150	E	6.8	63	42.8	6	150	3	1049	944	682	157	142	102
TCJE106M063#0100	E	10	63	63.0	6	100	3	1285	1156	835	128	116	83
TCJE106M063#0150	E	10	63	63.0	6	150	3	1049	944	682	157	142	102
75 Volt @ 85°C (60 Volt @ 105°C)													
TCJD475M075#0150	D	4.7	75	35.3	6	150	3	1000	900	650	150	135	98
TCJD685M075#0120	D	6.8	75	51.0	6	120	3	1118	1006	727	134	121	87
100 Volt @ 85°C (80 Volt @ 105°C)													
TCJV685M100#0250	V	6.8	100	68.0	8	250	3	1000	900	650	250	225	163
125 Volt @ 85°C (100 Volt @ 105°C)													
TCJD335M125#0250	D	3.3	125	41.2	8	250	3	775	697	503	194	174	126

Moisture Sensitivity Level (MSL) is defined according to J-STD-020.

All technical data relates to an ambient temperature of +25°C. Capacitance and DF are measured at 120Hz, 0.5RMS with DC bias of 2.2 volts. DCL is measured at rated voltage after 5 minutes.

ESR allowed to move up to 1.25 times catalog limit post mounting.

For typical weight and composition see page 144.

NOTE: AVX reserves the right to supply a higher voltage rating or tighter tolerance part in the same case size, to the same reliability standards.

Voltage vs Temperature Rating

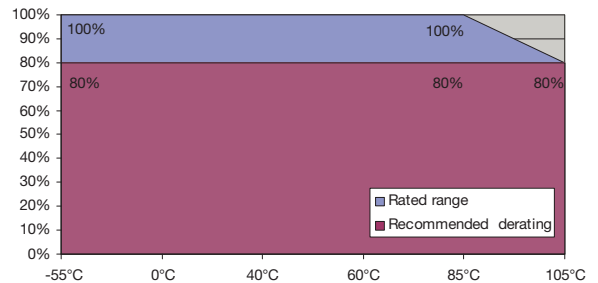

TCM Series



Tantalum Solid Electrolytic Chip Capacitors Conductive Polymer Multianode

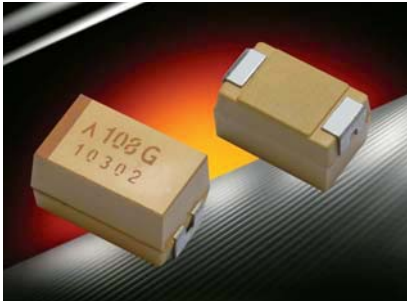

- Conductive polymer multianode
- Extremely Low ESR
- Reduced ignition failure mode
- 3x reflow 260°C compatible
- Volumetric efficiency
- High frequency capacitance retention

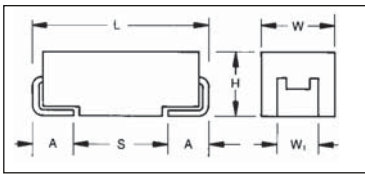

CASE DIMENSIONS: millimeters (inches)

Code	EIA Code	EIA Metric	L±0.20 (0.008)	W±0.20 (0.008) -0.10 (0.004)	H±0.20 (0.008) -0.10 (0.004)	W ₁ ±0.20 (0.008)	A±0.30 (0.012) -0.20 (0.008)	S Min.
E	2917	7343-43	7.30 (0.287)	4.30 (0.169)	4.10 (0.162)	2.40 (0.094)	1.30 (0.051)	4.40 (0.173)

W₁ dimension applies to the termination width for A dimensional area only.

For part marking see page 151

HOW TO ORDER

TCM	E	108	M	004	R	0010
Type	Case Size See table above	Capacitance Code pF code: 1st two digits represent significant figures, 3rd digit represents multiplier (number of zeros to follow)	Tolerance M=±20%	Rated DC Voltage 004=4Vdc 006=6.3Vdc 010=10Vdc 035=35Vdc	Packaging R = Pure Tin 7" Reel S = Pure Tin 13" Reel	ESR in mΩ

TECHNICAL SPECIFICATIONS

Technical Data:	All technical data relate to an ambient temperature of +25°C					
Capacitance Range:	22 μF to 1000 μF					
Capacitance Tolerance:	±20%					
Leakage Current DCL:	0.1CV					
Rated Voltage (V _R)	≤ +85°C:	4	6.3	10	35	
Category Voltage (V _C)	≤ +105°C:	3.2	5	8	28	
Surge Voltage (V _S)	≤ +85°C:	5.2	8	13	46	
Surge Voltage (V _S)	≤ +105°C:	4	6	10	35	
Temperature Range:	-55°C to +105°C					
Reliability:	1% per 1000 hours at 85°C, V _R with 0.1Ω/V series impedance, 60% confidence level					

Tantalum Solid Electrolytic Chip Capacitors Conductive Polymer Multianode

CAPACITANCE AND RATED VOLTAGE, VR (VOLTAGE CODE) RANGE (LETTER DENOTES CASE SIZE)

Capacitance		Rated Voltage DC (V _R) to 85°C			
μF	Code	4V (G)	6.3V (J)	10V (A)	35V (V)
22	226				E(25)
33	336				
47	476				
68	686				
100	107				
150	157				
220	227				
330	337			E(10,15)	
470	477				
680	687		E(12)		
1000	108	E(10,12)			
1500	158				

Available Ratings, (ESR ratings in mOhms in brackets)

Engineering samples - please contact manufacturer

*Codes under development – subject to change

Note: Voltage ratings are minimum values. AVX reserves the right to supply higher ratings in the same case size, to the same reliability standards.

RATINGS & PART NUMBER REFERENCE

AVX Part No.	Case Size	Capacitance (μF)	Rated Voltage (V)	DCL (μA) Max.	DF % Max.	ESR Max. (mΩ) @100kHz	MSL	100kHz RMS Current (mA)			100kHz RMS Voltage (mV)		
								25°C	85°C	105°C	25°C	85°C	105°C
4 Volt @ 85°C (3.2 Volt @ 105°C)													
TCME108M004#0010	E	1000	4	400	8	10	3	5196	4677	3377	52	47	34
TCME108M004#0012	E	1000	4	400	8	12	3	4743	4269	3083	57	51	37
6.3 Volt @85°C (5 Volt @ 105°C)													
TCME687M006#0012	E	680	6.3	408	8	12	3	4743	4269	3083	57	51	37
10 Volt @ 85°C (8 Volt @ 105°C)													
TCME337M010#0010	E	330	10	330	8	10	3	5196	4677	3377	52	47	34
TCME337M010#0015	E	330	10	330	8	15	3	4243	3818	2758	64	57	41
35 Volt @ 85°C (28 Volt @ 105°C)													
TCME226M035#0025	E	22	35	77	8	25	3	3286	2958	2136	82	74	53

Moisture Sensitivity Level (MSL) is defined according to J-STD-020.

All technical data relates to an ambient temperature of +25°C. Capacitance and DF are measured at 120Hz, 0.5RMS with DC bias of 2.2 volts. DCL is measured at rated voltage after 5 minutes.

ESR allowed to move up to 1.25 times catalog limit post mounting.

For typical weight and composition see page 144.

NOTE: AVX reserves the right to supply a higher voltage rating or tighter tolerance part in the same case size, to the same reliability standards.

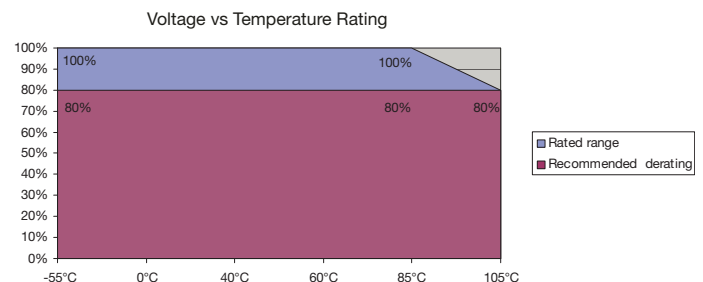

TCN Series



Tantalum Solid Electrolytic Chip Capacitors Undertab Series with Conductive Polymer Electrode



- Conductive polymer electrode reduces ignition failure mode
- Lower ESR
- Undertab terminations layout:
 - High Volumetric Efficiency
 - High PCB assembly density
 - High capacitance in smaller dimensions
- 3x reflow 260°C compatible
- Consumer applications (e.g. mobiles, MP3 etc.)
- 4 case sizes available

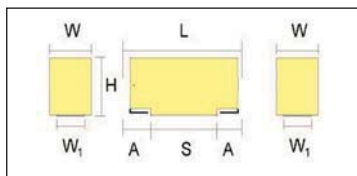

For part marking see page 151

CASE DIMENSIONS: millimeters (inches)

Code	EIA Code	EIA Metric	L±0.20 (0.008)	W±0.20 (0.008) -0.10 (0.004)	H max.	W _i ±0.20 (0.008)	A±0.30 (0.012) -0.20 (0.008)
L	1210	3528-10	3.50 (0.138)	2.80 (0.110)	1.00 (0.039)	2.20 (0.087)	0.80 (0.031)
N	0805	2012-10	2.05 (0.081)	1.30 (0.051)	1.00 (0.039)	1.00 (0.039)	0.50 (0.020)
S	1206	3216-12	3.20 (0.126)	1.60 (0.063)	1.20 (0.047)	1.20 (0.047)	0.80 (0.031)
T	1210	3528-12	3.50 (0.138)	2.80 (0.110)	1.20 (0.047)	2.20 (0.087)	0.80 (0.031)

W_i dimension applies to the termination width for A dimensional area only.

HOW TO ORDER

TCN

Type

L

Case Size
See table above

157

Capacitance Code
pF code: 1st two digits represent significant figures, 3rd digit represents multiplier (number of zeros to follow)

M

Tolerance
M = ±20%

006

Rated DC Voltage
004 = 4Vdc
006 = 6.3Vdc
010 = 10Vdc

R

Packaging
R = Pure Tin 7" Reel
S = Pure Tin 13" Reel

0200

ESR in mΩ

TECHNICAL SPECIFICATIONS

Technical Data:	All technical data relate to an ambient temperature of +25°C				
Capacitance Range:	15µF to 470 µF				
Capacitance Tolerance:	±20%				
Rated Voltage (V _R)	≤ +85°C:	4	6.3	10	
Category Voltage (V _C)	≤ +105°C:	3.2	5	8	
Surge Voltage (V _S)	≤ +85°C:	5.2	8	13	
Surge Voltage (V _S)	≤ +105°C:	4	6	10	
Temperature Range:	-55°C to +105°C				
Reliability:	1% per 1000 hours at 85°C, V _R with 0.1V _R series impedance with 60% confidence level				

Tantalum Solid Electrolytic Chip Capacitors Undertab Series with Conductive Polymer Electrode

CAPACITANCE AND RATED VOLTAGE, VR (VOLTAGE CODE) RANGE (LETTER DENOTES CASE SIZE)

Capacitance		Rated Voltage DC to 85°C / 0.66DC to 105°C		
µF	Code	4V (G)	6.3V (J)	10V (A)
15	156			N(500)*
22	226			N(500)*
33	336	N(500)*	K(500)*N(500)*	K(500)*N(500)*
47	476	N(500)*	K(500)* N(70,200,350)*N(500)	K(500)*S(500)*
68	686	K(500)*N(500)*	K(500)*S(500)*	G(150)*L(150)* S(500)*
100	107	K(500)*S(500)*	G(200)*L(200)/S(250)*	G(150)*L(150)* S(150)*T(150)*
150	157	G(200)*L(200)* S(500)*	K(200)* L(200)/S(200) T(200)	G(150)*H(150)* T(150)*
220	227	G(200)*L(150)* S(200)*T(150)*	H(100,200)*T(200)*	H(150)*
330	337	H(150)*T(150)*	H(200)*	
470	477	H(150)*		

Available Ratings, (ESR ratings in mOhms in brackets)

Engineering samples - please contact manufacturer

*Codes under development - subject to change

Note: Voltage ratings are minimum values. AVX reserves the right to supply higher ratings in the same case size, to the same reliability standards.

RATINGS & PART NUMBER REFERENCE

AVX Part No.	Case Size	Capacitance (µF)	Rated Voltage (V)	DCL (µA) Max.	DF % Max.	ESR Max. (mΩ) @100kHz	MSL	100kHz RMS Current (mA)			100kHz RMS Voltage (mV)		
								25°C	85°C	105°C	25°C	85°C	105°C
6.3 Volt @ 85°C (5 Volt @ 105°C)													
TCNN476M006#0500	N	47	6.3	28.2	10	500	3	283	255	184	141	127	92
TCNL107M006#0200	L	100	6.3	60	10	200	3	548	493	356	110	99	71
TCNL157M006#0200	L	150	6.3	90	10	200	3	548	493	356	110	99	71
TCNS157M006#0200	S	150	6.3	90	10	200	3	524	472	341	105	94	68
TCNT157M006#0200	T	150	6.3	90	10	200	3	592	532	385	118	106	77
TCNT227M006#0200	T	220	6.3	132	10	200	3	592	532	385	118	106	77

Moisture Sensitivity Level (MSL) is defined according to J-STD-020.

All technical data relates to an ambient temperature of +25°C. Capacitance and DF are measured at 120Hz, 0.5RMS with DC bias of 2.2 volts.

DCL is measured at rated voltage after 5 minutes.

ESR allowed to move up to 1.25 times catalog limit post mounting.

For typical weight and composition see page 144.

NOTE: AVX reserves the right to supply a higher voltage rating or tighter tolerance part in the same case size, to the same reliability standards.

Voltage vs Temperature Rating

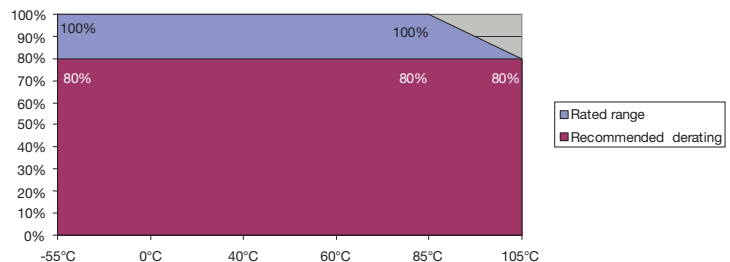

F38 Series



Conductive Polymer, Miniature, Frameless®

FRAMELESS™



- Compliant to the RoHS directive (2002/95/EC).

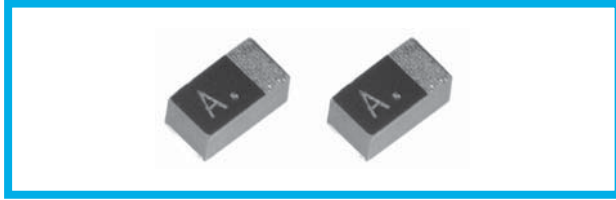

Applications

- Smartphone
- Wireless module
- Tablet PC
- Portable game

Catalog Numbering (Example: 10V 2.2uF)

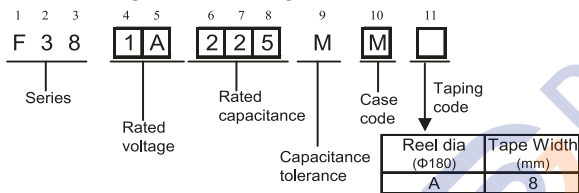

Dimensions

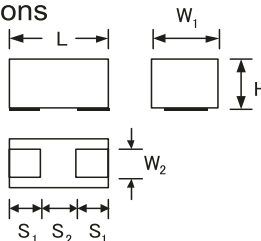

Case Code	L	W ₁	W ₂	H	S ₁	S ₂
M	1.6 ^{+0.2} _{-0.1}	0.85 ^{+0.2} _{-0.1}	0.65±0.1	0.8±0.1	0.5±0.1	0.6±0.1
S	2.0 ^{+0.2} _{-0.1}	1.25 ^{+0.2} _{-0.1}	0.9±0.1	0.8±0.1	0.5±0.1	1.0±0.1

Marking

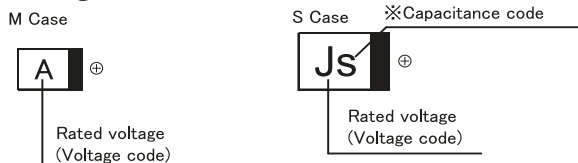

Standard ratings

μF	V			※ Capacitance code		
	Code	4	6.3		10	
2.2	225	0G	0J	1A	M	-
4.7	475				M	-
10	106				(M)	a
22	226				(M)	(S)
47	476				(M)·S	j
100	107	(S)				A

() The series in parentheses are being developed. Please contact to your local Nichicon sales office when these series are being designed in your application.

Specifications

Item	Performance Characteristics
Category	-55~+105°C (Rated temperature : +85°C)
Temperature Range	-55~+105°C (Rated temperature : +85°C)
Capacitance Tolerance	±20% (120Hz)
Dissipation Factor	Refer to the table below
E.S.R.	Refer to the table below
Leakage Current	Refer to the table below Provided that After 5 minute's application of rated voltage, leakage current at 105°C, 10 times or less than 20°C specified value.
Damp Heat (Steady State)	At 40°C, 90~95% R.H., For 500hours (No voltage applied) Capacitance Change...Refer to the table below (1) Dissipation Factor...200% or less of initial specified value Leakage Current...300% or less of initial specified value
Temperature Cycles	At -55°C / +105°C, For 30 minutes each, 5 cycles Capacitance Change...Refer to the table below (1) Dissipation Factor...200% or less of initial specified value Leakage Current...400% or less of initial specified value
Resistance to Soldering Heat	10 seconds reflow at 240°C Capacitance Change...Refer to the table below (1) Dissipation Factor...200% or less of initial specified value Leakage Current...300% or less of initial specified value
Surge	After application of surge in series with a 1kΩ resistor at the rate of 30 seconds ON, 30 seconds OFF, for 1000 successive test cycles at 85°C, capacitors meet the characteristics requirements tableed below. Capacitance Change...Refer to the table below (1) Dissipation Factor...200% or less of initial specified value Leakage Current...300% or less of initial specified value
Endurance	After 1000 hours' application of rated voltage in series with a 3Ω resistor at 85°C, capacitors meet the characteristic requirements tableed below Capacitance Change...Refer to the table below (1) Dissipation Factor...200% or less of initial specified value Leakage Current...400% or less of initial specified value
Shear Test	After applying the pressure load of 5N for 10±1 seconds horizontally to the center of capacitor side body which has no electrode and has been soldered beforehand on an substrate, there shall be found neither exfoliation nor its sign at the terminal electrode. 5N (0.51kg·f) For 10 ± 1seconds
Terminal Strength	Keeping a capacitor surface-mounted on a substrate upside down and supporting the substrate at both of the opposite bottom points 45mm apart from the center of the capacitor, the pressure strength is applied with a specified jig at the center of the substrate so that the substrate may bend by 1mm as illustrated. Then, there shall be found no remarkable abnormality on the capacitor terminals. R230 45 45

Standard ratings

Rated Volt	Rated Capacitance (μF)	Case code	Part Number	*2 Leakage Current (uA)	Dissipation Factor (%@120Hz)	ESR (mΩ@100kHz)	*1 ΔC/C (%)
6.3V	47	S	F380J476MSA	29.6	10	200	*
10V	2.2	M	F381A225MMA	10.0	6	500	*
	4.7	M	F381A475MMA	10.0	6	500	*

*1: ΔC/C Marked "※"

Item	M Case (%)
Damp heat, steady state	-20~+30
Rapid change of temperature	±20
Resistance to soldering heat	±20
Surge	±20
Endurance	±20

*2: Leakage Current

After 5 minute's application of rated voltage, leakage current at 20°C.

The correlations among rated voltage, surge voltage and derated voltage

Rated voltage(V)	6.3	10
85°C Surge voltage(V)	8	13
105°C Derated voltage(V)	5	8

(Notice) Design, Specifications are subject to change without notice.



TRJ Series



Professional Tantalum Chip Capacitor



- Improved reliability – 2x standard
- DCL reduced by 25% to 0.0075 CV
- Robust against higher thermo-mechanical stresses during assembly process
- CV range: 0.10-470µF / 4-50V
- 5 case sizes available
- 123 low ESR parts released
- Automotive, medical, aerospace, military and other high-end applications



SnPb termination option is not RoHS compliant.

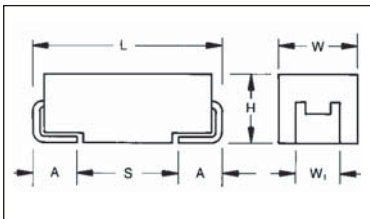

For part marking see page 151

CASE DIMENSIONS: millimeters (inches)

Code	EIA Code	EIA Metric	L±0.20 (0.008)	W+0.20 (0.008) -0.10 (0.004)	H+0.20 (0.008) -0.10 (0.004)	W ₁ ±0.20 (0.008)	A+0.30 (0.012) -0.20 (0.008)	S Min.
A	1206	3216-18	3.20 (0.126)	1.60 (0.063)	1.60 (0.063)	1.20 (0.047)	0.80 (0.031)	1.10 (0.043)
B	1210	3528-21	3.50 (0.138)	2.80 (0.110)	1.90 (0.075)	2.20 (0.087)	0.80 (0.031)	1.40 (0.055)
C	2312	6032-28	6.00 (0.236)	3.20 (0.126)	2.60 (0.102)	2.20 (0.087)	1.30 (0.051)	2.90 (0.114)
D	2917	7343-31	7.30 (0.287)	4.30 (0.169)	2.90 (0.114)	2.40 (0.094)	1.30 (0.051)	4.40 (0.173)
E	2917	7343-43	7.30 (0.287)	4.30 (0.169)	4.10 (0.162)	2.40 (0.094)	1.30 (0.051)	4.40 (0.173)

W₁ dimension applies to the termination width for A dimensional area only.

HOW TO ORDER

TRJ	B	105	*	035	R	RJ	-
Type	Case Size See table above	Capacitance Code pF code: 1st two digits represent significant figures, 3rd digit represents multiplier (number of zeros to follow)	Tolerance K=±10% M=±20%	Rated DC Voltage 004 = 4V 006 = 6.3V 010 = 10V 016 = 16V 020 = 20V 025 = 25V 035 = 35V 050 = 50V	Packaging R = Pure Tin 7" Reel S = Pure Tin 13" Reel A = Gold Plating 7" Reel B = Gold Plating 13" Reel H = Tin Lead 7" Reel (Contact Manufacturer) K = Tin Lead 13" Reel (Contact Manufacturer) H, K = Non RoHS	Standard Suffix OR 0100 Low ESR in mΩ	Additional characters may be added for special requirements V = Dry pack Option (selected codes only)

TECHNICAL SPECIFICATIONS

Technical Data:	All technical data relate to an ambient temperature of +25°C									
Capacitance Range:	0.10 µF to 470 µF									
Capacitance Tolerance:	±10%; ±20%									
Leakage Current DCL:	0.0075CV									
Rated Voltage (V _R)	≤ +85°C:	4	6.3	10	16	20	25	35	50	
Category Voltage (V _C)	≤ +125°C:	2.7	4	7	10	13	17	23	33	
Surge Voltage (V _S)	≤ +85°C:	5.2	8	13	20	26	32	46	65	
Surge Voltage (V _S)	≤ +125°C:	3.4	5	8	13	16	20	28	40	
Temperature Range:	-55°C to +125°C									
Reliability:	0.5% per 1000 hours at 85°C, V _R with 0.1Ω/V series impedance, 60% confidence level									
Termination Plating:	Sn Plating (standard), Gold and SnPb Plating upon request Meets requirements of AEC-Q200									



Professional Tantalum Chip Capacitor

CAPACITANCE AND RATED VOLTAGE, VR (VOLTAGE CODE) RANGE (LETTER DENOTES CASE SIZE)

Capacitance		Rated Voltage DC (V _R) to 85°C							
μF	Code	4V (G)	6.3V (J)	10V (A)	16V (C)	20V (D)	25V (E)	35V (V)	50V (T)
0.10	104							A	
0.15	154							A, A(6000)	
0.22	224							A, A(6000)	A, A(7000)
0.33	334							A, A(6000)	A
0.47	474						A, A(7000)	A, A(4000)	B
0.68	684						A, A(6000)	A, A(6000)	B, B(2000)
1.0	105				A	A, A(3000)	A, A(3000)	A, B, A(3000), B(2000)	C, B, B(2000)
1.5	155			A		A, A(3000)	A, B, A(3000)	A, B, A(2000), B(2500)	C, C(1500)
2.2	225			A	A, A(3500)	A, A(3000)	A, B, A(1600), B(1200)	B, B(2000)	C, D, C(1000), D(1200)
3.3	335				A, B, A(3500)	A, B, A(2500), B(1300)	B, B(2000)	B, C, D, B(1000), C(800)	C, D, C(1000), D(800)
4.7	475			A, A(2000)	A, B, A(2000), B(1500)	A, B, A(1800), B(1000)	B, B(1000)	B, C, D, B(1500), C(600)	D, D(600)
6.8	685			A, B, A(1800)	A, B, C, A(1500), B(1200)	B, C, B(1000)	B, C, B(1000), C(600)	C, D, C(600)	D
10	106		A, B, A(1500)	A, B, A(1800), B(800)	B, C, B(800)	B, C, B(1000), C(500)	C, D, C(600)	C, D, C(600), D(250,400)	E, E(300,400)
15	156	B	A, B, A(1500), B(700)	A, B, C, A(1000), B(600)	B, B(800)	B, C, D, B(500), C(400)	C, D, C(500), D(300)	D, D(225)	
22	226		A, B, C, A(900), B(600)	B, B(700)	B, C, D, B(600), C(350)	C, D, C(400), D(150,300)	D, D(300)	D, D(200,400)	
33	336	C	B, C, B(600)	B, C, D, B(650), C(300)	C, C(300)	C, D, C(300), D(250)	D, D(400)	E, E(150,250)	
47	476		B, C, B(500), C(250)	C, D, C(300)	C, D, C(350), D(200)	D, D(200)	D, E, D(250), E(150)		
68	686		C, C(200)	C, C(300)	C, D, C(200), D(150)	D, E, D(200), E(120,200)			
100	107		C, C(300)	C, D, E, C(200), D(100,150), E(100)	D, E, D(150), E(150)	E, E(150)			
150	157		C, D, C(300), D(150)	D, E, D(150), E(150)	E, E(150)				
220	227		D, D(150)	D, E, E(150)	U, U(200)				
330	337		D, E, E(150)	E, E(100)					
470	477		E, E(200)						

Not recommended for new designs, higher voltage or smaller case size substitution are offered.

Available Ratings, (ESR ratings in mOhms in brackets)

Engineering samples - please contact manufacturer

*Codes under development - subject to change

Note: Voltage ratings are minimum values. AVX reserves the right to supply higher ratings in the same case size, to the same reliability standards.

TRJ Series



Professional Tantalum Chip Capacitor

RATINGS & PART NUMBER REFERENCE

AVX Part No.	Case Size	Capacitance (µF)	Rated Voltage (V)	DCL (µA) Max.	DF % Max.	ESR Max. (mΩ) @100kHz	MSL	100kHz RMS Current (mA)			100kHz RMS Voltage (mV)		
								25°C	85°C	125°C	25°C	85°C	125°C
4 Volt @ 85°C (2.7 Volt @ 125°C)													
TRJB156*004#RJ	B	15	4	0.45	6	3000	1	168	151	67	505	454	202
TRJC336*004#RJ	C	33	4	1.0	6	2000	1	235	211	94	469	422	188
6.3 Volt @ 85°C (4 Volt @ 125°C)													
TRJA106*006#RJ	A	10	6.3	0.45	6	2200	1	185	166	74	406	366	162
TRJA106*006#1500	A	10	6.3	0.45	6	1500	1	224	201	89	335	302	134
TRJB106*006#RJ	B	10	6.3	0.45	6	3000	1	168	151	67	505	454	202
TRJA156*006#RJ	A	15	6.3	0.68	6	2030	1	192	173	77	390	351	156
TRJA156*006#1500	A	15	6.3	0.68	6	1500	1	224	201	89	335	302	134
TRJB156*006#RJ	B	15	6.3	0.68	6	2030	1	205	184	82	415	374	166
TRJB156*006#0700	B	15	6.3	0.68	6	700	1	348	314	139	244	220	98
TRJA226*006#RJ	A	22	6.3	0.99	6	1700	1	210	189	84	357	321	143
TRJA226*006#0900	A	22	6.3	0.99	6	900	1	289	260	115	260	234	104
TRJB226*006#RJ	B	22	6.3	0.99	6	1880	1	213	191	85	400	360	160
TRJB226*006#0600	B	22	6.3	0.99	6	600	1	376	339	151	226	203	90
TRJC226*006#RJ	C	22	6.3	0.99	6	2000	1	235	211	94	469	422	188
TRJB336*006#RJ	B	33	6.3	1.5	6	1740	1	221	199	88	385	346	154
TRJB336*006#0600	B	33	6.3	1.5	6	600	1	376	339	151	226	203	90
TRJC336*006#RJ	C	33	6.3	1.5	6	1800	1	247	222	99	445	400	178
TRJB476*006#RJ	B	47	6.3	2.1	6	1620	1	229	206	92	371	334	148
TRJB476*006#0500	B	47	6.3	2.1	6	500	1	412	371	165	206	186	82
TRJC476*006#RJ	C	47	6.3	2.1	6	540	1	451	406	181	244	219	97
TRJC476*006#0250	C	47	6.3	2.1	6	250	1	663	597	265	166	149	66
TRJC686*006#RJ	C	68	6.3	3.1	6	490	1	474	426	190	232	209	93
TRJC686*006#0200	C	68	6.3	3.1	6	200	1	742	667	297	148	133	59
TRJC107*006#RJ	C	100	6.3	4.5	6	440	1	500	450	200	220	198	88
TRJC107*006#0300	C	100	6.3	4.5	6	300	1	606	545	242	182	163	73
TRJC157*006#RJ	C	150	6.3	6.8	8	500	1	469	422	188	235	211	94
TRJC157*006#0300	C	150	6.3	6.8	8	300	1	606	545	242	182	163	73
TRJD157*006#RJ	D	150	6.3	6.8	6	400	1	612	551	245	245	220	98
TRJD157*006#0150	D	150	6.3	6.8	6	150	1	1000	900	400	150	135	60
TRJD227*006#RJ	D	220	6.3	9.9	8	360	1	645	581	258	232	209	93
TRJD227*006#0150	D	220	6.3	9.9	8	150	1	1000	900	400	150	135	60
TRJD337*006#RJ	D	330	6.3	14	8	400	1	612	551	245	245	220	98
TRJE337*006#RJ	E	330	6.3	14	8	330	1 ¹⁾	707	636	283	233	210	93
TRJE337*006#0150	E	330	6.3	14	8	150	1 ¹⁾	1049	944	420	157	142	63
TRJE477*006#RJ	E	470	6.3	21	8	250	1 ¹⁾	812	731	325	203	183	81
TRJE477*006#0200	E	470	6.3	21	8	200	1 ¹⁾	908	817	363	182	163	73
10 Volt @ 85°C (7 Volt @ 125°C)													
TRJA155*010#RJ	A	1.5	10	0.30	6	7000	1	104	93	41	725	652	290
TRJA225*010#RJ	A	2.2	10	0.30	6	7000	1	104	93	41	725	652	290
TRJA475*010#RJ	A	4.7	10	0.35	6	2900	1	161	145	64	466	420	187
TRJA475*010#2000	A	4.7	10	0.35	6	2000	1	194	174	77	387	349	155
TRJA685*010#RJ	A	6.8	10	0.51	6	2650	1	168	151	67	446	401	178
TRJA685*010#1800	A	6.8	10	0.51	6	1800	1	204	184	82	367	331	147
TRJB685*010#RJ	B	6.8	10	0.51	6	3000	1	168	151	67	505	454	202
TRJA106*010#RJ	A	10	10	0.75	6	2200	1	185	166	74	406	366	162
TRJA106*010#1800	A	10	10	0.75	6	1800	1	204	184	82	367	331	147
TRJB106*010#RJ	B	10	10	0.75	6	2200	1	197	177	79	432	389	173
TRJB106*010#0800	B	10	10	0.75	6	800	1	326	293	130	261	235	104
TRJA156*010#RJ	A	15	10	1.10	6	1800	1	204	184	82	367	331	147
TRJA156*010#1000	A	15	10	1.10	6	1000	1	274	246	110	274	246	110
TRJB156*010#RJ	B	15	10	1.1	6	2030	1	205	184	82	415	374	166
TRJB156*010#0600	B	15	10	1.1	6	600	1	376	339	151	226	203	90
TRJC156*010#RJ	C	15	10	1.1	6	2000	1	235	211	94	469	422	188
TRJB226*010#RJ	B	22	10	1.7	6	1880	1	213	191	85	400	360	160
TRJB226*010#0700	B	22	10	1.7	6	700	1	348	314	139	244	220	98
TRJB336*010#RJ	B	33	10	2.5	6	1000	1	292	262	117	292	262	117
TRJB336*010#0650	B	33	10	2.5	6	650	1	362	325	145	235	212	94
TRJC336*010#RJ	C	33	10	2.5	6	590	1	432	389	173	255	229	102
TRJC336*010#0300	C	33	10	2.5	6	300	1	606	545	242	182	163	73
TRJD336*010#RJ	D	33	10	2.5	6	1100	1	369	332	148	406	366	162
TRJC476*010#RJ	C	47	10	3.5	6	540	1	451	406	181	244	219	97
TRJC476*010#0300	C	47	10	3.5	6	300	1	606	545	242	182	163	73
TRJD476*010#RJ	D	47	10	3.5	6	400	1	612	551	245	245	220	98
TRJC686*010#RJ	C	68	10	5.1	6	490	1	474	426	190	232	209	93
TRJC686*010#0300	C	68	10	5.1	6	300	1	606	545	242	182	163	73
TRJC107*010#RJ	C	100	10	7.5	8	500	1	469	422	188	235	211	94
TRJC107*010#0200	C	100	10	7.5	8	200	1	742	667	297	148	133	59
TRJD107*010#RJ	D	100	10	7.5	6	440	1	584	525	234	257	231	103
TRJD107*010#0100	D	100	10	7.5	6	100	1	1225	1102	490	122	110	49
TRJD107*010#0150	D	100	10	7.5	6	150	1	1000	900	400	150	135	60

¹⁾ Dry pack option (see How to order) recommended for reduction of stress during soldering. Dry pack parts should be treated as MSL 3.
 Moisture Sensitivity Level (MSL) is defined according to J-STD-020.
 All technical data relates to an ambient temperature of +25°C. Capacitance and DF are measured at 120Hz, 0.5V RMS with a maximum DC bias of 2.2 volts.
 DCL is measured at rated voltage after 5 minutes.

The EIA & CECC standards for low ESR Solid Tantalum Capacitors allow an ESR movement to 1.25 times catalogue limit post mounting.
 For typical weight and composition see page 144.

NOTE: AVX reserves the right to supply a higher voltage rating or tighter tolerance part in the same case size, to the same reliability standards.



TRJ Series



Professional Tantalum Chip Capacitor

RATINGS & PART NUMBER REFERENCE

AVX Part No.	Case Size	Capacitance (µF)	Rated Voltage (V)	DCL (µA) Max.	DF % Max.	ESR Max. (mΩ) @100kHz	MSL	100kHz RMS Current (mA)			100kHz RMS Voltage (mV)		
								25°C	85°C	125°C	25°C	85°C	125°C
TRJE107*010#RJ	E	100	10	7.5	6	440	1 ¹⁾	612	551	245	269	242	108
TRJE107*010#0100	E	100	10	7.5	6	100	1 ¹⁾	1285	1156	514	128	116	51
TRJD157*010#RJ	D	150	10	11	8	400	1	612	551	245	245	220	98
TRJD157*010#0150	D	150	10	11	8	150	1	1000	900	400	150	135	60
TRJE157*010#RJ	E	150	10	11	8	400	1 ¹⁾	642	578	257	257	231	103
TRJE157*010#0150	E	150	10	11	8	150	1 ¹⁾	1049	944	420	157	142	63
TRJD227*010#RJ	D	220	10	17	8	500	1	548	493	219	274	246	110
TRJE227*010#RJ	E	220	10	17	8	360	1 ¹⁾	677	609	271	244	219	97
TRJE227*010#0150	E	220	10	17	8	150	1 ¹⁾	1049	944	420	157	142	63
TRJE337*010#RJ	E	330	10	25	8	300	1 ¹⁾	742	667	297	222	200	89
TRJE337*010#100	E	330	10	25	8	10.0	1 ¹⁾	1285	1156	514	128	116	51
16 Volt @ 85°C (10 Volt @ 125°C)													
TRJA105*016#RJ	A	1.0	16	0.30	6	10000	1	87	78	35	866	779	346
TRJA225*016#RJ	A	2.2	16	0.30	6	4550	1	128	116	51	584	526	234
TRJA225*016#3500	A	2.2	16	0.30	6	3500	1	146	132	59	512	461	205
TRJA335*016#RJ	A	3.3	16	0.40	6	3740	1	142	127	57	530	477	212
TRJA335*016#3500	A	3.3	16	0.40	6	3500	1	146	132	59	512	461	205
TRJB335*016#RJ	B	3.3	16	0.40	6	4500	1	137	124	55	618	557	247
TRJA475*016#RJ	A	4.7	16	0.56	6	3160	1	154	139	62	487	438	195
TRJA475*016#2000	A	4.7	16	0.56	6	2000	1	194	174	77	387	349	155
TRJB475*016#RJ	B	4.7	16	0.56	6	3160	1	164	148	66	518	466	207
TRJB475*016#1500	B	4.7	16	0.56	6	1500	1	238	214	95	357	321	143
TRJA685*016#RJ	A	6.8	16	0.82	4	2000	1	194	174	77	387	349	155
TRJA685*016#1500	A	6.8	16	0.82	4	1500	1	224	201	89	335	302	134
TRJB685*016#RJ	B	6.8	16	0.82	6	2650	1	179	161	72	475	427	190
TRJB685*016#1200	B	6.8	16	0.82	6	1200	1	266	240	106	319	287	128
TRJC685*016#RJ	C	6.8	16	0.82	6	2500	1	210	189	84	524	472	210
TRJB106*016#RJ	B	10	16	1.2	6	2200	1	197	177	79	432	389	173
TRJB106*016#0800	B	10	16	1.2	6	800	1	326	293	130	261	235	104
TRJC106*016#RJ	C	10	16	1.2	6	2000	1	235	211	94	469	422	188
TRJB156*016#RJ	B	15	16	1.8	6	2030	1	205	184	82	415	374	166
TRJB156*016#0800	B	15	16	1.8	6	800	1	326	293	130	261	235	104
TRJB226*016#RJ	B	22	16	2.6	6	1100	1	278	250	111	306	275	122
TRJB226*016#0600	B	22	16	2.6	6	600	1	376	339	151	226	203	90
TRJC226*016#RJ	C	22	16	2.6	6	700	1	396	357	159	277	250	111
TRJC226*016#0350	C	22	16	2.6	6	350	1	561	505	224	196	177	78
TRJD226*016#RJ	D	22	16	2.6	6	1100	1	369	332	148	406	366	162
TRJC336*016#RJ	C	33	16	4.0	6	590	1	432	389	173	255	229	102
TRJC336*016#0300	C	33	16	4.0	6	300	1	606	545	242	182	163	73
TRJC476*016#RJ	C	47	16	5.6	6	540	1	451	406	181	244	219	97
TRJC476*016#0350	C	47	16	5.6	6	350	1	561	505	224	196	177	78
TRJD476*016#RJ	D	47	16	5.6	6	540	1	527	474	211	285	256	114
TRJD476*016#0200	D	47	16	5.6	6	200	1	866	779	346	173	156	69
TRJC686*016#RJ	C	68	16	8.2	6	490	1	474	426	190	232	209	93
TRJC686*016#0200	C	68	16	8.2	6	200	1	742	667	297	148	133	59
TRJD686*016#RJ	D	68	16	8.2	6	490	1	553	498	221	271	244	108
TRJD686*016#0150	D	68	16	8.2	6	150	1	1000	900	400	150	135	60
TRJD107*016#RJ	D	100	16	12	6	440	1	584	525	234	257	231	103
TRJD107*016#0150	D	100	16	12	6	150	1	1000	900	400	150	135	60
TRJE107*016#RJ	E	100	16	12	6	440	1 ¹⁾	612	551	245	269	242	108
TRJE107*016#0150	E	100	16	12	6	150	1 ¹⁾	1049	944	420	157	142	63
TRJE157*016#RJ	E	150	16	16	6	300	1 ¹⁾	742	667	297	222	200	89
TRJE157*016#0150	E	150	16	16	6	150	1 ¹⁾	1049	944	420	157	142	63
TRJU227*016#RJ	U	220	16	26.4	12	500	3	574	517	230	287	259	115
TRJU227*016#R0200V	U	220	16	26.4	12	200	3	908	817	363	182	163	73
20 Volt @ 85°C (13 Volt @ 125°C)													
TRJA105*020#RJ	A	1	20	0.30	4	6630	1	106	96	43	705	635	282
TRJA105*020#3000	A	1	20	0.30	4	3000	1	158	142	63	474	427	190
TRJA155*020#RJ	A	1.5	20	0.30	6	5460	1	117	105	47	640	576	256
TRJA155*020#3000	A	1.5	20	0.30	6	3000	1	158	142	63	474	427	190
TRJA225*020#RJ	A	2.2	20	0.33	6	4550	1	128	116	51	584	526	234
TRJA225*020#3000	A	2.2	20	0.33	6	3000	1	158	142	63	474	427	190
TRJA335*020#RJ	A	3.3	20	0.50	6	3740	1	142	127	57	530	477	212
TRJA335*020#2500	A	3.3	20	0.50	6	2500	1	173	156	69	433	390	173
TRJB335*020#RJ	B	3.3	20	0.50	6	3740	1	151	136	60	564	507	226
TRJB335*020#1300	B	3.3	20	0.50	6	1300	1	256	230	102	332	299	133
TRJA475*020#RJ	A	4.7	20	0.71	5	2500	1	184	166	74	461	415	184
TRJA475*020#1800	A	4.7	20	0.71	5	1800	1	217	196	87	391	352	156
TRJB475*020#RJ	B	4.7	20	0.71	6	3160	1	164	148	66	518	466	207
TRJB475*020#1000	B	4.7	20	0.71	6	1000	1	292	262	117	292	262	117
TRJB685*020#RJ	B	6.8	20	1.0	6	2650	1	179	161	72	475	427	190

¹⁾ Dry pack option (see How to order) recommended for reduction of stress during soldering. Dry pack parts should be treated as MSL 3.
Moisture Sensitivity Level (MSL) is defined according to J-STD-020.
All technical data relates to an ambient temperature of +25°C. Capacitance and DF are measured at 120Hz, 0.5V RMS with a maximum DC bias of 2.2 volts.
DCL is measured at rated voltage after 5 minutes.

The EIA & CECC standards for low ESR Solid Tantalum Capacitors allow an ESR movement to 1.25 times catalogue limit post mounting.
For typical weight and composition see page 144.
NOTE: AVX reserves the right to supply a higher voltage rating or tighter tolerance part in the same case size, to the same reliability standards.



TRJ Series



Professional Tantalum Chip Capacitor

RATINGS & PART NUMBER REFERENCE

AVX Part No.	Case Size	Capacitance (µF)	Rated Voltage (V)	DCL (µA) Max.	DF % Max.	ESR Max. (mΩ) @100kHz	MSL	100kHz RMS Current (mA)			100kHz RMS Voltage (mV)		
								25°C	85°C	125°C	25°C	85°C	125°C
TRJB685*020#1000	B	6.8	20	1.0	6	1000	1	292	262	117	292	262	117
TRJC685*020#RJ	C	6.8	20	1.0	6	2000	1	235	211	94	469	422	188
TRJB106*020#RJ	B	10	20	1.5	6	2200	1	197	177	79	432	389	173
TRJB106*020#1000	B	10	20	1.5	6	1000	1	292	262	117	292	262	117
TRJC106*020#RJ	C	10	20	1.5	6	800	1	371	334	148	297	267	119
TRJC106*020#0500	C	10	20	1.5	6	500	1	469	422	188	235	211	94
TRJB156*020#RJ	B	15	20	2.3	6	1400	1	280	252	112	392	353	157
TRJB156*020#0500	B	15	20	2.3	6	500	1	469	422	188	235	211	94
TRJC156*020#RJ	C	15	20	2.3	6	720	1	391	352	156	281	253	113
TRJC156*020#0400	C	15	20	2.3	6	400	1	524	472	210	210	189	84
TRJD156*020#RJ	D	15	20	2.3	6	1100	1	369	332	148	406	366	162
TRJC226*020#RJ	C	22	20	3.3	6	650	1	411	370	165	267	241	107
TRJC226*020#0400	C	22	20	3.3	6	400	1	524	472	210	210	189	84
TRJD226*020#RJ	D	22	20	3.3	6	650	1	480	432	192	312	281	125
TRJD226*020#0150	D	22	20	3.3	6	150	1	1000	900	400	150	135	60
TRJD226*020#0300	D	22	20	3.3	6	300	1	707	636	283	212	191	85
TRJC336*020#RJ	C	33	20	5.0	6	590	1	432	389	173	255	229	102
TRJC336*020#0300	C	33	20	5.0	6	300	1	606	545	242	182	163	73
TRJD336*020#RJ	D	33	20	5.0	6	590	1	504	454	202	297	268	119
TRJD336*020#0250	D	33	20	5.0	6	250	1	775	697	310	194	174	77
TRJD476*020#RJ	D	47	20	7.1	6	540	1	527	474	211	285	256	114
TRJD476*020#0200	D	47	20	7.1	6	200	1	866	779	346	173	156	69
TRJD686*020#RJ	D	68	20	10	6	490	1	553	498	221	271	244	108
TRJD686*020#0200	D	68	20	10	6	200	1	866	779	346	173	156	69
TRJE686*020#RJ	E	68	20	10	6	490	1 ¹⁾	580	522	232	284	256	114
TRJE686*020#0120	E	68	20	10	6	120	1 ¹⁾	1173	1055	469	141	127	56
TRJE686*020#0200	E	68	20	10	6	200	1 ¹⁾	908	817	363	182	163	73
TRJE107*020#RJ	E	100	20	15	6	300	1 ¹⁾	742	667	297	222	200	89
TRJE107*020#0150	E	100	20	15	6	150	1 ¹⁾	1049	944	420	157	142	63
25 Volt @ 85°C (17 Volt @ 125°C)													
TRJA474*025#RJ	A	0.47	25	0.30	4	9530	1	89	80	35	845	761	338
TRJA474*025#7000	A	0.47	25	0.30	4	7000	1	104	93	41	725	652	290
TRJA684*025#RJ	A	0.68	25	0.30	4	7980	1	97	87	39	774	696	309
TRJA684*025#6000	A	0.68	25	0.30	4	6000	1	112	101	45	671	604	268
TRJA105*025#RJ	A	1	25	0.30	4	6630	1	106	96	43	705	635	282
TRJA105*025#3000	A	1	25	0.30	4	3000	1	158	142	63	474	427	190
TRJA155*025#RJ	A	1.5	25	0.30	6	5460	1	117	105	47	640	576	256
TRJA155*025#3000	A	1.5	25	0.30	6	3000	1	158	142	63	474	427	190
TRJB155*025#RJ	B	1.5	25	0.30	6	5000	1	130	117	52	652	587	261
TRJA225*025#RJ	A	2.2	25	0.41	6	2900	1	161	145	64	466	420	187
TRJA225*025#1600	A	2.2	25	0.41	6	1600	1	217	195	87	346	312	139
TRJB225*025#RJ	B	2.2	25	0.41	6	4550	1	137	123	55	622	560	249
TRJB225*025#1200	B	2.2	25	0.41	6	1200	1	266	240	106	319	287	128
TRJB335*025#RJ	B	3.3	25	0.62	6	3740	1	151	136	60	564	507	226
TRJB335*025#2000	B	3.3	25	0.62	6	2000	1	206	186	82	412	371	165
TRJB475*025#RJ	B	4.7	25	0.88	6	3160	1	164	148	66	518	466	207
TRJB475*025#1000	B	4.7	25	0.88	6	1000	1	292	262	117	292	262	117
TRJB685*025#RJ	B	6.8	25	1.30	6	1500	1	238	214	95	357	321	143
TRJB685*025#1000	B	6.8	25	1.30	6	1000	1	292	262	117	292	262	117
TRJC685*025#RJ	C	6.8	25	1.3	6	1070	1	321	289	128	343	309	137
TRJC685*025#0600	C	6.8	25	1.3	6	600	1	428	385	171	257	231	103
TRJC106*025#RJ	C	10	25	1.9	6	800	1	371	334	148	297	267	119
TRJC106*025#0600	C	10	25	1.9	6	600	1	428	385	171	257	231	103
TRJD106*025#RJ	D	10	25	1.9	6	1200	1	354	318	141	424	382	170
TRJC156*025#RJ	C	15	25	2.8	6	720	1	391	352	156	281	253	113
TRJC156*025#0500	C	15	25	2.8	6	500	1	469	422	188	235	211	94
TRJD156*025#RJ	D	15	25	2.8	6	720	1	456	411	183	329	296	131
TRJD156*025#0300	D	15	25	2.8	6	300	1	707	636	283	212	191	85
TRJD226*025#RJ	D	22	25	4.1	6	650	1	480	432	192	312	281	125
TRJD226*025#0300	D	22	25	4.1	6	300	1	707	636	283	212	191	85
TRJD336*025#RJ	D	33	25	6.2	6	590	1	504	454	202	297	268	119
TRJD336*025#0400	D	33	25	6.2	6	400	1	612	551	245	245	220	98
TRJD476*025#RJ	D	47	25	8.8	6	540	1	527	474	211	285	256	114
TRJD476*025#0250	D	47	25	8.8	6	250	1	775	697	310	194	174	77
TRJE476*025#RJ	E	47	25	8.8	6	540	1 ¹⁾	553	497	221	298	269	119
TRJE476*025#0150	E	47	25	8.8	6	150	1 ¹⁾	1049	944	420	157	142	63
35 Volt @ 85°C (23 Volt @ 125°C)													
TRJA104*035#RJ	A	0.1	35	0.30	4	20000	1	61	55	24	1225	1102	490
TRJA154*035#RJ	A	0.15	35	0.30	4	16470	1	67	61	27	1111	1000	445
TRJA154*035#6000	A	0.15	35	0.30	4	6000	1	112	101	45	671	604	268
TRJA224*035#RJ	A	0.22	35	0.30	4	13710	1	74	67	30	1014	913	406

¹⁾ Dry pack option (see How to order) recommended for reduction of stress during soldering. Dry pack parts should be treated as MSL 3.
Moisture Sensitivity Level (MSL) is defined according to J-STD-020.
All technical data relates to an ambient temperature of +25°C. Capacitance and DF are measured at 120Hz, 0.5V RMS with a maximum DC bias of 2.2 volts.
DCL is measured at rated voltage after 5 minutes.

The EIA & CECC standards for low ESR Solid Tantalum Capacitors allow an ESR movement to 1.25 times catalogue limit post mounting.
For typical weight and composition see page 144.
NOTE: AVX reserves the right to supply a higher voltage rating or tighter tolerance part in the same case size, to the same reliability standards.



TRJ Series



Professional Tantalum Chip Capacitor

RATINGS & PART NUMBER REFERENCE

AVX Part No.	Case Size	Capacitance (µF)	Rated Voltage (V)	DCL (µA) Max.	DF % Max.	ESR Max. (mΩ) @100kHz	MSL	100kHz RMS Current (mA)			100kHz RMS Voltage (mV)		
								25°C	85°C	125°C	25°C	85°C	125°C
TRJA224*035#6000	A	0.22	35	0.30	4	6000	1	112	101	45	671	604	268
TRJA334*035#RJ	A	0.33	35	0.30	4	11280	1	82	73	33	920	828	368
TRJA334*035#6000	A	0.33	35	0.30	4	6000	1	112	101	45	671	604	268
TRJA474*035#RJ	A	0.47	35	0.30	4	9530	1	89	80	35	845	761	338
TRJA474*035#4000	A	0.47	35	0.30	4	4000	1	137	123	55	548	493	219
TRJA684*035#RJ	A	0.68	35	0.30	4	7980	1	97	87	39	774	696	309
TRJA684*035#6000	A	0.68	35	0.30	4	6000	1	112	101	45	671	604	268
TRJA105*035#RJ	A	1	35	0.30	4	6630	1	106	96	43	705	635	282
TRJA105*035#3000	A	1	35	0.30	4	3000	1	158	142	63	474	427	190
TRJB105*035#RJ	B	1	35	0.30	4	3400	1	158	142	63	538	484	215
TRJB105*035#2000	B	1	35	0.30	4	2000	1	206	186	82	412	371	165
TRJA155*035#RJ	A	1.5	35	0.39	6	3100	1	166	149	66	513	462	205
TRJA155*035#2000	A	1.5	35	0.39	6	2000	1	206	186	82	412	371	165
TRJB155*035#RJ	B	1.5	35	0.39	6	5460	1	125	112	50	681	613	272
TRJB155*035#2500	B	1.5	35	0.39	6	2500	1	184	166	74	461	415	184
TRJB225*035#RJ	B	2.2	35	0.58	6	4550	1	137	123	55	622	560	249
TRJB225*035#2000	B	2.2	35	0.58	6	2000	1	206	186	82	412	371	165
TRJB335*035#RJ	B	3.3	35	0.87	6	3740	1	151	136	60	564	507	226
TRJB335*035#1000	B	3.3	35	0.87	6	1000	1	292	262	117	292	262	117
TRJC335*035#RJ	C	3.3	35	0.87	6	1840	1	245	220	98	450	405	180
TRJC335*035#0800	C	3.3	35	0.87	6	800	1	371	334	148	297	267	119
TRJD335*035#RJ	D	3.3	35	0.87	6	2000	1	274	246	110	548	493	219
TRJB475*035#RJ	B	4.7	35	1.20	6	2200	1	224	201	89	492	443	197
TRJB475*035#1500	B	4.7	35	1.20	6	1500	1	271	244	108	406	366	162
TRJC475*035#RJ	C	4.7	35	1.2	6	1410	1	279	251	112	394	354	158
TRJC475*035#0600	C	4.7	35	1.2	6	600	1	428	385	171	257	231	103
TRJD475*035#RJ	D	4.7	35	1.2	6	1500	1	316	285	126	474	427	190
TRJC685*035#RJ	C	6.8	35	1.8	6	1070	1	321	289	128	343	309	137
TRJC685*035#0600	C	6.8	35	1.8	6	600	1	428	385	171	257	231	103
TRJD685*035#RJ	D	6.8	35	1.8	6	1300	1	340	306	136	442	397	177
TRJC106*035#RJ	C	10	35	2.6	6	800	1	371	334	148	297	267	119
TRJC106*035#0600	C	10	35	2.6	6	600	1	428	385	171	257	231	103
TRJD106*035#RJ	D	10	35	2.6	6	800	1	433	390	173	346	312	139
TRJD106*035#0250	D	10	35	2.6	6	250	1	775	697	310	194	174	77
TRJD106*035#0400	D	10	35	2.6	6	400	1	612	551	245	245	220	98
TRJD156*035#RJ	D	15	35	3.9	6	720	1	456	411	183	329	296	131
TRJD156*035#0225	D	15	35	3.9	6	225	1	816	735	327	184	165	73
TRJD226*035#RJ	D	22	35	5.8	6	650	1	480	432	192	312	281	125
TRJD226*035#0200	D	22	35	5.8	6	200	1	866	779	346	173	156	69
TRJD226*035#0400	D	22	35	5.8	6	400	1	612	551	245	245	220	98
TRJE336*035#RJ	E	33	35	8.7	6	590	1 ¹⁾	529	476	212	312	281	125
TRJE336*035#0150	E	33	35	8.7	6	150	1 ¹⁾	1049	944	420	157	142	63
TRJE336*035#0250	E	33	35	8.7	6	250	1 ¹⁾	812	731	325	203	183	81
50 Volt @ 85°C (33 Volt @ 125°C)													
TRJA224*050#RJ	A	0.22	50	0.3	4	7500	1	100	90	40	750	675	300
TRJA224*050#7000	A	0.22	50	0.3	4	7000	1	104	93	41	725	652	290
TRJA334*050#RJ	A	0.33	50	0.3	4	7000	1	104	93	41	725	652	290
TRJB474*050#RJ	B	0.47	50	0.3	4	5000	1	130	117	52	652	587	261
TRJB684*050#RJ	B	0.68	50	0.3	4	4000	1	146	131	58	583	525	233
TRJB684*050#2000	B	0.68	50	0.3	4	2000	1	206	186	82	412	371	165
TRJB105*050#RJ	B	1	50	0.4	4	3400	1	158	142	63	538	484	215
TRJB105*050#2000	B	1	50	0.4	4	2000	1	206	186	82	412	371	165
TRJC105*050#RJ	C	1	50	0.4	4	3000	1	191	172	77	574	517	230
TRJC155*050#RJ	C	1.5	50	0.6	6	2500	1	210	189	84	524	472	210
TRJC155*050#1500	C	1.5	50	0.6	6	1500	1	271	244	108	406	366	162
TRJC225*050#RJ	C	2.2	50	0.8	6	1700	1	254	229	102	432	389	173
TRJC225*050#1000	C	2.2	50	0.8	6	1000	1	332	298	133	332	298	133
TRJD225*050#RJ	D	2.2	50	0.8	4.5	2000	1	274	246	110	548	493	219
TRJD225*050#1200	D	2.2	50	0.8	4.5	1200	1	354	318	141	424	382	170
TRJC335*050#RJ	C	3.3	50	1.2	6	1400	1	280	252	112	392	353	157
TRJC335*050#1000	C	3.3	50	1.2	6	1000	1	332	298	133	332	298	133
TRJD335*050#RJ	D	3.3	50	1.20	4.5	1100	1	369	332	148	406	366	162
TRJD335*050#0800	D	3.3	50	1.20	4.5	800	1	433	390	173	346	312	139
TRJD475*050#RJ	D	4.7	50	1.80	4.5	900	1	408	367	163	367	331	147
TRJD475*050#0600	D	4.7	50	1.80	4.5	600	1	500	450	200	300	270	120
TRJD685*050#RJ	D	6.8	50	2.60	4.5	700	1	463	417	185	324	292	130
TRJE106*050#RJ	E	10	50	3.80	4.5	700	1 ¹⁾	486	437	194	340	306	136
TRJE106*050#0300	E	10	50	3.80	4.5	300	1 ¹⁾	742	667	297	222	200	89
TRJE106*050#0400	E	10	50	3.80	4.5	400	1 ¹⁾	642	578	257	257	231	103

1¹⁾ Dry pack option (see How to order) recommended for reduction of stress during soldering. Dry pack parts should be treated as MSL 3.
 Moisture Sensitivity Level (MSL) is defined according to J-STD-020.
 All technical data relates to an ambient temperature of +25°C. Capacitance and DF are measured at 120Hz, 0.5V RMS with a maximum DC bias of 2.2 volts.
 DCL is measured at rated voltage after 5 minutes.

The EIA & CECC standards for low ESR Solid Tantalum Capacitors allow an ESR movement to 1.25 times catalogue limit post mounting.
 For typical weight and composition see page 144.

NOTE: AVX reserves the right to supply a higher voltage rating or tighter tolerance part in the same case size, to the same reliability standards.



F97 Series



Resin-Molded Chip, Improved Reliability J-Lead



- Compliant to the RoHS directive (2002/95/EC).
- Compliant to AEC-Q200.
- Improved reliability - FR=0.5%/1000hrs (twice better than standard)

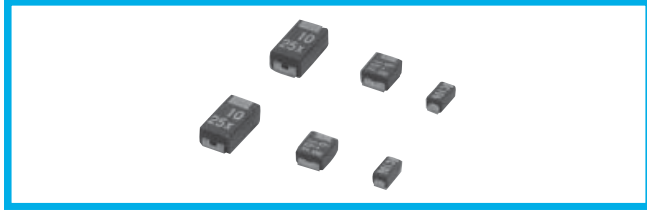

Applications

- Automotive electronics (Engine ECU)
- Industrial equipment

Type numbering system (Example: 16V 3.3μF)

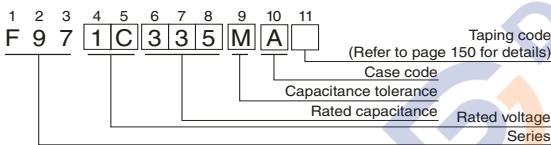

Drawing

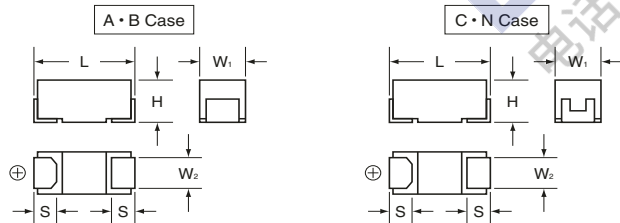

Dimensions

Case code	L	W ₁	W ₂	H	S
A	3.2 ± 0.2	1.6 ± 0.2	1.2 ± 0.1	1.6 ± 0.2	0.8 ± 0.2
B	3.5 ± 0.2	2.8 ± 0.2	2.2 ± 0.1	1.9 ± 0.2	0.8 ± 0.2
C	6.0 ± 0.2	3.2 ± 0.2	2.2 ± 0.1	2.5 ± 0.2	1.3 ± 0.2
N	7.3 ± 0.2	4.3 ± 0.2	2.4 ± 0.1	2.8 ± 0.2	1.3 ± 0.2

Marking

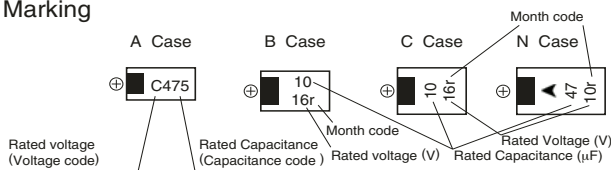

Standard ratings

V	6.3	10	16	20	25	35
Cap. (μF)	0J	1A	1C	1D	1E	1V
0.47	474					A
0.68	684			A	A	A
1	105			A	A	(A)
1.5	155		A	A		(A) · B
2.2	225	A	A	A	(A) · B	B
3.3	335	A	A	A	B	(B) · C
4.7	475	A	A · B	A · B	A · B	(B) · C
6.8	685	A · B	B	B	(B) · C	C
10	106		A · B	A · B · C	(B) · C	C · N
15	156	B	B	(B) · C	N	(C) · N
22	226	A · B	A · B	B · C · N	C · N	(N)
33	336	A · C	B · C · N	B · C · N		(N)
47	476	B · C	(B) · C · N	(C) · N		
68	686	N	N			
100	107	N	(C) · (N)			

Specifications

Item	Performance Characteristics
Category	Temperature Range
	-55 to +125°C (Rated temperature : +85°C)
Capacitance Tolerance	±20%, ±10% (at 120Hz)
Dissipation Factor	Refer to next page
ESR (100kHz)	Refer to next page
Leakage Current	<ul style="list-style-type: none"> ● After 1 minute's application of rated voltage, leakage current at 20°C is not more than 0.01CV or 0.5μA, whichever is greater. ● After 1 minute's application of rated voltage, leakage current at 85°C is not more than 0.1CV or 5μA, whichever is greater. ● After 1 minute's application of derated voltage, leakage current at 125°C is not more than 0.125CV or 6.3μA, whichever is greater.
Capacitance Change by Temperature	+15% Max. (at +125°C) +10% Max. (at +85°C) -10% Max. (at -55°C)
Damp Heat (Steady State)	At 85°C, 85% R.H., For 1000 hours (No voltage applied) Capacitance Change Within ±10% of the initial value Dissipation Factor Initial specified value or less Leakage Current 125% or less than the initial specified value
Load Humidity	After 500 hour's application of rated voltage in series with a 33Ω resistor at 60°C, 90 to 95% R.H., capacitors meet the characteristics requirements table below. Capacitance Change Within ±10% of the initial value Dissipation Factor Initial specified value or less Leakage Current 125% or less than the initial specified value
Temperature Cycles	At -55°C / +125°C, For 30 minutes each, 1000 cycles Capacitance Change Within ±10% of the initial value Dissipation Factor Initial specified value or less Leakage Current Initial specified value or less
Resistance to Soldering Heat	10 seconds reflow at 260°C, 5 seconds immersion at 260°C. Capacitance Change Within ±5% of the initial value Dissipation Factor Initial specified value or less Leakage Current Initial specified value or less
Solderability	After immersing capacitors completely into a solder pot at 245°C for 2 to 3 seconds, more than 3/4 of their electrode area shall remain covered with new solder.
Surge	After application of surge in series with a 33Ω resistor at the rate of 30 seconds ON, 30 seconds OFF, for 1000 successive test cycles at 85°C, capacitors shall meet the characteristic requirements table below. Capacitance Change Within ±5% of the initial value Dissipation Factor Initial specified value or less Leakage Current Initial specified value or less
Endurance	After 2000 hours' application of rated voltage in series with a 3Ω resistor at 85°C, or derated voltage in series with a 3Ω resistor at 125°C, capacitors shall meet the characteristic requirements table below. Capacitance Change Within ±10% of the initial value Dissipation Factor Initial specified value or less Leakage Current Initial specified value or less
Shear Test	After applying the pressure load of 5N for 10 ± 1 seconds horizontally to the center of capacitor side body which has no electrode and has been soldered beforehand on a substrate, there shall be found neither exfoliation nor its sign at the terminal electrode.
Terminal Strength	Keeping a capacitor surface-mounted on a substrate upside down and supporting the substrate at both of the opposite bottom points 45mm apart from the center of capacitor, the pressure strength is applied with a specified jig at the center of the substrate so that substrate may bend by 1mm as illustrated. Then, there shall be found no remarkable abnormality on the capacitor terminals.
Failure Rate	0.5% per 1000 hours at 85°C, V _R with 0.1Ω/V series impedance, 60% confidence level.

() The series in parentheses are being developed.

Please contact to your local AVX sales office when these series are being designed in your application.



F97 Series



Resin-Molded Chip, Improved Reliability J-Lead

■ Standard Ratings

Rated Volt	Rated Capacitance (μF)	Case code	Part Number	Leakage Current (μA)	Dissipation Factor (%@120Hz)	ESR (Ω@100kHz)	
6.3V	3.3	A	F970J335MAA	0.5	4	4.5	
	4.7	A	F970J475MAA	0.5	6	4.0	
	6.8	A	F970J685MAA	0.5	6	3.5	
	6.8	B	F970J685MBA	0.5	6	2.5	
	15	B	F970J156MBA	0.9	6	2.0	
	22	A	F970J226MAA	1.4	12	2.5	
	22	B	F970J226MBA	1.4	8	1.9	
	33	A	F970J336MAA	2.1	12	2.5	
	33	C	F970J336MCC	2.1	6	1.1	
	47	B	F970J476MBA	3.0	8	1.0	
	47	C	F970J476MCC	3.0	6	0.9	
	68	N	F970J686MNC	4.3	6	0.6	
	100	N	F970J107MNC	6.3	8	0.6	
10V	2.2	A	F971A225MAA	0.5	4	5.0	
	3.3	A	F971A335MAA	0.5	4	4.5	
	4.7	A	F971A475MAA	0.5	6	4.0	
	4.7	B	F971A475MBA	0.5	6	2.8	
	6.8	B	F971A685MBA	0.7	6	2.5	
	10	A	F971A106MAA	1.0	6	3.0	
	10	B	F971A106MBA	1.0	6	2.0	
	15	B	F971A156MBA	1.5	6	2.0	
	22	A	F971A226MAA	2.2	15	3.0	
	22	B	F971A226MBA	2.2	8	1.9	
	33	B	F971A336MBA	3.3	8	1.9	
	33	C	F971A336MCC	3.3	6	1.1	
	33	N	F971A336MNC	3.3	6	0.7	
	47	C	F971A476MCC	4.7	8	0.9	
	47	N	F971A476MNC	4.7	6	0.7	
	68	N	F971A686MNC	6.8	6	0.6	
16V	1.5	A	F971C155MAA	0.5	4	6.3	
	2.2	A	F971C225MAA	0.5	4	5.0	
	3.3	A	F971C335MAA	0.5	4	4.5	
	4.7	A	F971C475MAA	0.8	8	4.0	
	4.7	B	F971C475MBA	0.8	6	2.8	
	6.8	B	F971C685MBA	1.1	6	2.5	
	10	A	F971C106MAA	1.6	8	3.5	
	10	B	F971C106MBA	1.6	6	2.1	
	10	C	F971C106MCC	1.6	6	1.5	
	15	C	F971C156MCC	2.4	6	1.2	
	22	B	F971C226MBA	3.5	8	1.9	
	22	C	F971C226MCC	3.5	8	1.1	
	22	N	F971C226MNC	3.5	6	0.7	
	33	B	F971C336MBA	5.3	10	2.1	
	33	C	F971C336MCC	5.3	8	1.1	
33	N	F971C336MNC	5.3	6	0.7		
47	N	F971C476MNC	7.5	8	0.7		
20V	0.68	A	F971D684MAA	0.5	4	7.6	
	1	A	F971D105MAA	0.5	4	7.5	
	1.5	A	F971D155MAA	0.5	4	6.7	
	2.2	A	F971D225MAA	0.5	6	6.3	
	3.3	B	F971D335MBA	0.7	4	3.1	
	4.7	A	F971D475MAA	0.9	8	4.0	
	4.7	B	F971D475MBA	0.9	6	2.8	
	6.8	C	F971D685MCC	1.4	6	1.8	
	10	C	F971D106MCC	2.0	6	1.5	
	15	N	F971D156MNC	3.0	6	0.7	
	22	C	F971D226MCC	4.4	8	1.1	
	22	N	F971D226MNC	4.4	6	0.7	
25V	0.68	A	F971E684MAA	0.5	4	7.6	
	1	A	F971E105MAA	0.5	4	7.5	
	2.2	B	F971E225MBA	0.6	4	3.8	
	3.3	B	F971E335MBA	0.8	4	3.5	
	4.7	C	F971E475MCC	1.2	6	1.8	
	6.8	C	F971E685MCC	1.7	6	1.8	
	10	C	F971E106MCC	2.5	6	1.6	
	10	N	F971E106MNC	2.5	6	1.0	
	15	N	F971E156MNC	3.8	6	0.7	
	35V	0.47	A	F971V474MAA	0.5	4	10.0
		0.68	A	F971V684MAA	0.5	4	7.6
		1.5	B	F971V155MBA	0.5	4	4.0
		2.2	B	F971V225MBA	0.8	4	3.8
		3.3	C	F971V335MCC	1.2	4	2.0
		4.7	C	F971V475MCC	1.6	6	1.8
6.8		N	F971V685MNC	2.4	6	1.0	
10	N	F971V106MNC	3.5	6	1.0		

* In case of capacitance tolerance ±10% type, **[K]** will be put at 9th digit of type numbering system.

TRM Professional Multianode



Tantalum Ultra Low ESR Capacitor

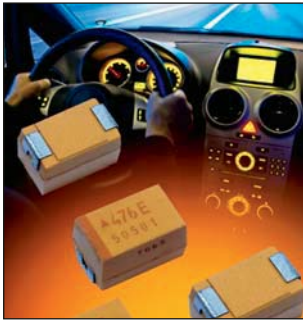

- Improved reliability – 0.5%/1khrs (twice better than standard)
- DCL reduced by 25% to 0.0075 CV
- Robust against higher thermo-mechanical stresses during assembly process
- Multi-anode construction
- Super low ESR
- CV range 22-1500 μ F / 2.5-35V
- “Mirror” construction used with D case capacitors reduces ESL to half
- Automotive, medical, aerospace, military and other hi-end application



SnPb termination option is not RoHS compliant.

MULTIANODE CONSTRUCTION

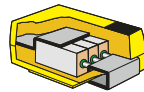

MULTIANODE TRMD LOW SELF INDUCTANCE CONSTRUCTION “MIRROR” DESIGN

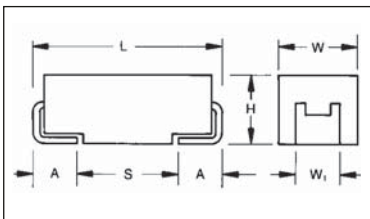
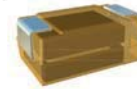

CASE DIMENSIONS: millimeters (inches)

Code	EIA Code	EIA Metric	L \pm 0.20 (0.008)	W+0.20 (0.008) -0.10 (0.004)	H+0.20 (0.008) -0.10 (0.004)	W \pm 0.20 (0.008)	A+0.30 (0.012) -0.20 (0.008)	S Min.
D	2917	7343-31	7.30 (0.287)	4.30 (0.169)	2.90 (0.114)	2.40 (0.094)	1.30 (0.051)	4.40 (0.173)
E	2917	7343-43	7.30 (0.287)	4.30 (0.169)	4.10 (0.162)	2.40 (0.094)	1.30 (0.051)	4.40 (0.173)

W₁ dimension applies to the termination width for A dimensional area only.

For part marking see page 151

HOW TO ORDER

TRM

Type

E

Case Size
See table above

108

Capacitance Code
pF code: 1st two digits represent significant figures, 3rd digit represents multiplier (number of zeros to follow)

Tolerance
K=±10%
M=±20%

004

Rated DC Voltage
002 = 2.5Vdc
004 = 4Vdc
006 = 6.3Vdc
010 = 10Vdc
012 = 12Vdc
016 = 16Vdc
020 = 20Vdc
025 = 25Vdc
035 = 35Vdc

R

Packaging

R = Pure Tin 7" Reel
S = Pure Tin 13" Reel
H = Tin Lead 7" Reel (Contact Manufacturer)
K = Tin Lead 13" Reel (Contact Manufacturer)
H, K = Non RoHS

0023

ESR in m Ω

TECHNICAL SPECIFICATIONS

Technical Data:

All technical data relate to an ambient temperature of +25°C

Capacitance Range: 22 μ F to 1500 μ F

Capacitance Tolerance: ±10%; ±20%

Rated Voltage (V _R)	≤ +85°C:	2.5	4	6.3	10	12	16	20	25	35
Category Voltage (V _C)	≤ +125°C:	1.7	2.7	4	7	8.4	10	13	17	23
Surge Voltage (V _S)	≤ +85°C:	3.3	5.2	8	13	15.6	20	26	32	46
Surge Voltage (V _S)	≤ +125°C:	2.2	3.4	5	8	9.6	13	16	20	28

Temperature Range: -55°C to +125°C

Reliability: 0.5% per 1000 hours at 85°C, V_R with 0.1 Ω /V series impedance, 60% confidence level

Meets requirements of AEC-Q200

TRM Professional Multianode



Tantalum Ultra Low ESR Capacitor

CAPACITANCE AND RATED VOLTAGE, VR (VOLTAGE CODE) RANGE (LETTER DENOTES CASE SIZE)

Capacitance		Rated Voltage DC (V_R) to 85°C									
μF	Code	2.5V (e)	4V (G)	6.3V (J)	10V (A)	12V (B)	16V (C)	20V (D)	25V (E)	35V (V)	50V (T)
6.8	685										
10	106										E(150)*
15	156										
22	226									D(70)/E(60,100)	
33	336								D(65)	E(50,65)	
47	476							D(55)	E(65)		
68	686										
100	107						D(55)*	E(35,45)			
150	157				D(45)*		E(30,40)				
220	227				D(35)	E(35)					
330	337		D(35)	D(35)	E(35)						
470	477		D(35)	E(30)							
680	687		E(23)								
1000	108	D(25)	E(23)								
1500	158	E(18)									
2200	228										

Available Ratings, (ESR ratings in mOhms in brackets)

Engineering samples - please contact manufacturer

*Codes under development - subject to change

Note: Voltage ratings are minimum values. AVX reserves the right to supply higher ratings in the same case size, to the same reliability standards.

TRM Professional Multianode



Tantalum Ultra Low ESR Capacitor

RATINGS & PART NUMBER REFERENCE

AVX Part No.	Case Size	Capacitance (µF)	Rated Voltage (V)	DCL (µA) Max.	DF % Max.	ESR Max. (mΩ) @100kHz	MSL	100kHz RMS Current (A)			100kHz RMS Voltage (V)		
								25°C	85°C	125°C	25°C	85°C	125°C
2.5 Volt @ 85°C (1.7 Volt @ 125°C)													
TRMD108*002#0025	D	1000	2.5	18.8	8	25	3	3.194	2.874	1.277	0.080	0.072	0.032
TRME158*002#0018	E	1500	2.5	28.1	6	18	3	3.873	3.486	1.549	0.070	0.063	0.028
4 Volt @ 85°C (2.7 Volt @ 125°C)													
TRMD337*004#0035	D	330	4	9.9	8	35	3	2.699	2.429	1.080	0.094	0.085	0.038
TRMD477*004#0035	D	470	4	14.1	8	35	3	2.699	2.429	1.080	0.094	0.085	0.038
TRME687*004#0023	E	680	4	20.4	6	23	3	3.426	3.084	1.370	0.079	0.071	0.032
TRME108*004#0023	E	1000	4	30	6	23	3	3.426	3.084	1.370	0.079	0.071	0.032
6.3 Volt @ 85°C (4 Volt @ 125°C)													
TRMD337*006#0035	D	330	6.3	14.9	8	35	3	2.699	2.429	1.080	0.094	0.085	0.038
TRME477*006#0030	E	470	6.3	21.2	6	30	3	3.000	2.700	1.200	0.090	0.081	0.036
10 Volt @ 85°C (7 Volt @ 125°C)													
TRMD227*010#0035	D	220	10	16.5	8	35	3	2.699	2.429	1.080	0.094	0.085	0.038
TRME337*010#0035	E	330	10	24.8	6	35	3	2.777	2.500	1.111	0.097	0.087	0.039
12 Volt @ 85°C (8.4 Volt @ 125°C)													
TRME227*012#0035	E	220	12	19.8	6	35	3	2.777	2.500	1.111	0.097	0.087	0.039
16 Volt @ 85°C (10 Volt @ 125°C)													
TRME157*016#0030	E	150	16	18	6	30	3	3.000	2.700	1.200	0.090	0.081	0.036
TRME157*016#0040	E	150	16	18	6	40	3	2.598	2.338	1.039	0.104	0.094	0.042
20 Volt @ 85°C (13 Volt @ 125°C)													
TRMD476*020#0055	D	47	20	7.1	8	55	3	2.153	1.938	0.861	0.118	0.107	0.047
TRME107*020#0035	E	100	20	15	6	35	3	2.777	2.500	1.111	0.097	0.087	0.039
TRME107*020#0045	E	100	20	15	6	45	3	2.449	2.205	0.980	0.110	0.099	0.044
25 Volt @ 85°C (17 Volt @ 125°C)													
TRMD336*025#0065	D	33	25	6.2	8	65	3	1.981	1.783	0.792	0.129	0.116	0.051
TRME476*025#0065	E	47	25	8.8	6	65	3	2.038	1.834	0.815	0.132	0.119	0.053
35 Volt @ 85°C (23 Volt @ 125°C)													
TRMD226*035#0070	D	22	35	5.8	8	70	3	1.909	1.718	0.763	0.134	0.120	0.053
TRME226*035#0060	E	22	35	5.8	6	60	3	2.121	1.909	0.849	0.127	0.115	0.051
TRME226*035#0100	E	22	35	5.8	6	100	3	1.643	1.479	0.657	0.164	0.148	0.066
TRME336*035#0050	E	33	35	8.7	6	50	3	2.324	2.091	0.930	0.116	0.105	0.046
TRME336*035#0065	E	33	35	8.7	6	65	3	2.038	1.834	0.815	0.132	0.119	0.053

Moisture Sensitivity Level (MSL) is defined according to J-STD-020.

All technical data relates to an ambient temperature of +25°C. Capacitance and DF are measured at 120Hz, 0.5V RMS with a maximum DC bias of 2.2 volts. DCL is measured at rated voltage after 5 minutes.

The EIA & CECC standards for low ESR Solid Tantalum Capacitors allow an ESR movement to 1.25 times catalogue limit post mounting.

For typical weight and composition see page 144.

NOTE: AVX reserves the right to supply a higher voltage rating or tighter tolerance part in the same case size, to the same reliability standards.

THJ Series



High Temperature Tantalum Chip Capacitor



- Improved reliability – 2x standard
- 175°C @ 0.5V_R continuous operation
- CV range: 0.10-220µF / 6.3-50V
- 5 case sizes available
- Low ESR options on approval
- High temperature automotive and industry applications



SnPb termination option is not
RoHS compliant.

CASE DIMENSIONS: millimeters (inches)

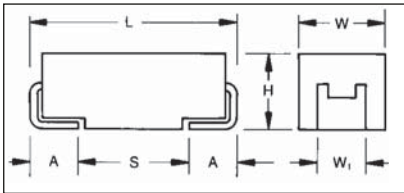

For part marking see page 151

Code	EIA Code	EIA Metric	L±0.20 (0.008)	W+0.20 (0.008) -0.10 (0.004)	H+0.20 (0.008) -0.10 (0.004)	W ₁ ±0.20 (0.008)	A+0.30 (0.012) -0.20 (0.008)	S Min.
A	1206	3216-18	3.20 (0.126)	1.60 (0.063)	1.60 (0.063)	1.20 (0.047)	0.80 (0.031)	1.10 (0.043)
B	1210	3528-21	3.50 (0.138)	2.80 (0.110)	1.90 (0.075)	2.20 (0.087)	0.80 (0.031)	1.40 (0.055)
C	2312	6032-28	6.00 (0.236)	3.20 (0.126)	2.60 (0.102)	2.20 (0.087)	1.30 (0.051)	2.90 (0.114)
D	2917	7343-31	7.30 (0.287)	4.30 (0.169)	2.90 (0.114)	2.40 (0.094)	1.30 (0.051)	4.40 (0.173)
E	2917	7343-43	7.30 (0.287)	4.30 (0.169)	4.10 (0.162)	2.40 (0.094)	1.30 (0.051)	4.40 (0.173)

W₁ dimension applies to the termination width for A dimensional area only.

HOW TO ORDER

THJ	B	105	*	035	R	JN	-
Type	Case Size See table above	Capacitance Code pF code: 1st two digits represent significant figures 3rd digit represents multiplier (number of zeros to follow)	Tolerance K=±10% M=±20%	Rated DC Voltage 006=6.3Vdc 010=10Vdc 016=16Vdc 020=20Vdc 025=25Vdc 035=35Vdc 050=50Vdc	Packaging R = Pure Tin 7" Reel S = Pure Tin 13" Reel A = Gold Plating 7" Reel B = Gold Plating 13" Reel H = Tin Lead 7" Reel (Contact Manufacturer) K = Tin Lead 13" Reel (Contact Manufacturer) H, K = Non RoHS	Standard Suffix OR 0100 Low ESR in mΩ	Additional characters may be added for special requirements V = Dry pack Option (selected codes only)

TECHNICAL SPECIFICATIONS

Technical Data:	All technical data relate to an ambient temperature of +25°C								
Capacitance Range:	0.10 µF to 220 µF								
Capacitance Tolerance:	±10%; ±20%								
Rated Voltage (V _R)	≤ +85°C:	6.3	10	16	20	25	35	50	
Category Voltage (V _C)	≤ +125°C:	4	7	10	13	17	23	33	
Category Voltage (V _C)	≤ +175°C:	3	5	8	10	12	17	25	
Surge Voltage (V _S)	≤ +85°C:	8	13	20	26	32	46	65	
Surge Voltage (V _S)	≤ +125°C:	5	8	13	16	20	28	40	
Surge Voltage (V _S)	≤ +175°C:	4	6	10	12	15	21	30	
Temperature Range:	-55°C to 175°C voltage derating.								
Reliability:	0.5% per 1000 hours at 85°C, V _R with 0.1Ω/V series impedance, 60% confidence level, 3.5 Fits at 40°C, 0.5V _R								
Termination Finish:	Sn Plating (standard), Gold Plating available on request								
	Meets requirements of AEC-Q200								



THJ Series



High Temperature Tantalum Chip Capacitor

CAPACITANCE AND RATED VOLTAGE, VR (VOLTAGE CODE) RANGE (LETTER DENOTES CASE SIZE)

Capacitance		Rated voltage (V _R) to 85°C (Voltage Code)						
µF	Code	6.3V (J)	10V (A)	16V (C)	20V (D)	25V (E)	35V (V)	50V (T)
0.10	104						A	
0.15	154						A	
0.22	224						A	
0.33	334						A	
0.47	474					A	B	
0.68	684					A	B	
1.0	105					A	A/B	
1.5	155				A		C	
2.2	225			A		B	C	
3.3	335		A	A	B		C	D
4.7	475	A	A	A/B			C	D
6.8	685	A	A	A/B			D	D
10	106	A	B	B		C	D	D/E
15	156	B	B	B			D	
22	226	B	B	C, C(500)	C	D	D, D(300)	
33	336	B	C	C	D		E	
47	476	C	C	C/D				
68	686	C	D	D				
100	107	D	D	E				
150	157	D						
220	227		E					

Available Ratings, (ESR ratings in mOhms in brackets)

Engineering samples - please contact manufacturer

*Codes under development - subject to change

Note: Voltage ratings are minimum values. AVX reserves the right to supply higher ratings in the same case size, to the same reliability standards.

THJ Series



High Temperature Tantalum Chip Capacitor

RATINGS & PART NUMBER REFERENCE

AVX Part No.	Case Size	Cap (µF)	Rated Voltage (V)	DCL (µA) Max.	DF % Max.	ESR Max. (Ω) @100kHz	MSL
6.3 Volt @ 85°C (3 Volt @ 175°C) / J							
THJA475*006#JN	A	4.7	6.3	0.5	6	6	1
THJA685*006#JN	A	6.8	6.3	0.5	4.5	2.6	1
THJA106*006#JN	A	10	6.3	0.6	4.5	2.2	1
THJB156*006#JN	B	15	6.3	0.9	6	2.5	1
THJB226*006#JN	B	22	6.3	1.4	6	2.5	1
THJB336*006#JN	B	33	6.3	1.9	6	2.2	1
THJC476*006#JN	C	47	6.3	3.0	6	1.6	1
THJC686*006#JN	C	68	6.3	4.3	6	1.5	1
THJD107*006#JN	D	100	6.3	6	4.5	0.4	1
THJD157*006#JN	D	150	6.3	9.5	6	0.9	1
10 Volt @ 85°C (5 Volt @ 175°C) / A							
THJA335*010#JN	A	3.3	10	0.5	6	5.5	1
THJA475*010#JN	A	4.7	10	0.5	4.5	2.9	1
THJA685*010#JN	A	6.8	10	0.7	4.5	2.6	1
THJB106*010#JN	B	10	10	1	4.5	1.8	1
THJB156*010#JN	B	15	10	1.5	4.5	1.5	1
THJB226*010#JN	B	22	10	2.2	6	2.4	1
THJC336*010#JN	C	33	10	3.3	6	1.6	1
THJC476*010#JN	C	47	10	4.7	4.5	0.5	1
THJD686*010#JN	D	68	10	6.8	4.5	0.4	1
THJD107*010#JN	D	100	10	10	6	0.9	1
THJE227*010#JN	E	220	10	22	10	0.5	1 ¹⁾
16 Volt @ 85°C (8 Volt @ 175°C) / C							
THJA225*016#JN	A	2.2	16	0.5	6	6.5	1
THJA335*016#JN	A	3.3	16	0.5	6	5	1
THJA475*016#JN	A	4.7	16	0.8	4.5	2.9	1
THJB475*016#JN	B	4.7	16	0.8	6	3.5	1
THJA685*016#JN	A	6.8	16	1.1	6	3.5	1
THJB685*016#JN	B	6.8	16	1.1	6	2.5	1
THJB106*016#JN	B	10	16	1.6	6	2.8	1
THJB156*016#JN	B	15	16	2.4	6	2	1
THJC226*016#JN	C	22	16	3.5	6	1.6	1
THJC226*016#0500	C	22	16	3.5	4.5	0.5	1
THJC336*016#JN	C	33	16	5.3	6	1.5	1
THJC476*016#JN	C	47	16	7.5	6	0.8	1
THJD476*016#JN	D	47	16	7.5	6	0.9	1
THJD686*016#JN	D	68	16	10.9	4.5	0.9	1
THJE107*016#JN	E	100	16	16	8	0.4	1 ¹⁾

AVX Part No.	Case Size	Cap (µF)	Rated Voltage (V)	DCL (µA) Max.	DF % Max.	ESR Max. (Ω) @100kHz	MSL
20 Volt @ 85°C (10 Volt @ 175°C) / D							
THJA155*020#JN	A	1.5	20	0.5	6	6.5	1
THJB335*020#JN	B	3.3	20	0.7	6	3	1
THJC156*020#JN	C	15	20	3.0	6	1.7	1
THJD336*020#JN	D	33	20	6.6	6	0.9	1
25 Volt @ 85°C (12 Volt @ 175°C) / E							
THJA474*025#JN	A	0.47	25	0.5	4	14	1
THJA684*025#JN	A	0.68	25	0.5	4	10	1
THJA105*025#JN	A	1.0	25	0.5	3	5.2	1
THJB225*025#JN	B	2.2	25	0.6	6	4.5	1
THJC685*025#JN	C	6.8	25	1.7	6	2	1
THJC106*025#JN	C	10	25	2.5	6	1.8	1
THJD226*025#JN	D	22	25	5.5	6	0.9	1
THJD336*025#JN	D	33	25	8.3	6	0.9	1
35 Volt @ 85°C (17 Volt @ 175°C) / V							
THJA104*035#JN	A	0.1	35	0.5	4	24	1
THJA154*035#JN	A	0.15	35	0.5	4	21	1
THJA224*035#JN	A	0.22	35	0.5	4	18	1
THJA334*035#JN	A	0.33	35	0.5	4	15	1
THJB474*035#JN	B	0.47	35	0.5	4	10	1
THJB684*035#JN	B	0.68	35	0.5	4	8	1
THJA105*035#JN	A	1.0	35	0.5	4	7.5	1
THJB105*035#JN	B	1.0	35	0.5	4	6.5	1
THJC155*035#JN	C	1.5	35	0.5	6	4.5	1
THJC225*035#JN	C	2.2	35	0.8	6	3.5	1
THJC335*035#JN	C	3.3	35	1.2	6	2.5	1
THJC475*035#JN	C	4.7	35	1.6	6	2.2	1
THJD685*035#JN	D	6.8	35	2.4	6	1.3	1
THJD106*035#JN	D	10	35	3.5	6	1	1
THJD156*035#JN	D	15	35	5.3	6	0.9	1
THJD226*035#JN	D	22	35	7.7	6	0.6	1
THJD226*035#0300	D	22	35	7.7	6	0.3	1
THJE336*035#JN	E	33	35	11.6	6	0.5	1 ¹⁾
50 Volt @ 85°C (25 Volt @ 175°C) / T							
THJD335*050#JN	D	3.3	50	1.7	6	1.1	1
THJD475*050#JN	D	4.7	50	2.4	6	0.9	1
THJD685*050#JN	D	6.8	50	3.4	6	0.7	1
THJD106*050#JN	D	10	50	5	6	0.7	1
THJE106*050#JN	E	10	50	5	6	0.7	1 ¹⁾

¹⁾ Dry pack option (see How to order) recommended for reduction of stress during soldering. Dry pack parts should be treated as MSL 3.

Moisture Sensitivity Level (MSL) is defined according to J-STD-020.

All technical data relates to an ambient temperature of +25°C. Capacitance and DF are measured at 120Hz, 0.5V RMS with a maximum DC bias of 2.2 volts.

DCL is measured at rated voltage after 5 minutes.

The EIA & CECC standards for low ESR Solid Tantalum Capacitors allow an ESR movement to 1.25 times catalogue limit post mounting.

For typical weight and composition see page 144.

NOTE: AVX reserves the right to supply a higher voltage rating or tighter tolerance part in the same case size, to the same reliability standards.

THJ 175°C Voltage vs Temperature Rating

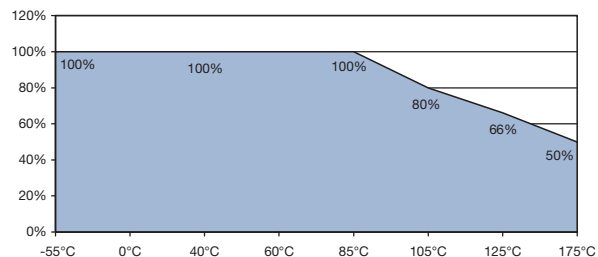

THJ Series with Extension to 200°C



High Temperature Tantalum Chip Capacitor



- SMD 200°C tantalum capacitor
- 200°C @ 0.33V_R 1000hrs continuous operation
- Leakage current after 200°C 1000hrs less than 1mA
- 3x reflow 260°C
- Gold plated termination for hybrid assembly
- Oil drilling, aerospace, automotive applications
- CV range: 10-220μF / 10-16V
- 2 case sizes available

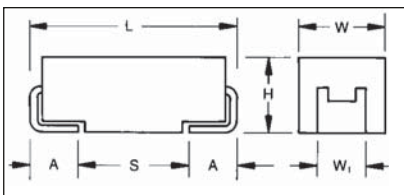

For part marking see page 151

CASE DIMENSIONS: millimeters (inches)

Code	EIA Code	EIA Metric	L±0.20 (0.008)	W+0.20 (0.008) -0.10 (0.004)	H+0.20 (0.008) -0.10 (0.004)	W ₁ ±0.20 (0.008)	A+0.30 (0.012) -0.20 (0.008)	S Min.
B	1210	3528-21	3.50 (0.138)	2.80 (0.110)	1.90 (0.075)	2.20 (0.087)	0.80 (0.031)	1.40 (0.055)
E	2917	7343-43	7.30 (0.287)	4.30 (0.169)	4.10 (0.162)	2.40 (0.094)	1.30 (0.051)	4.40 (0.173)

W₁ dimension applies to the termination width for A dimensional area only.

HOW TO ORDER

THJ	E	107	*	016	A	JH
Type	Case Size See table above	Capacitance Code pF code: 1st two digits represent significant figures 3rd digit represents multiplier (number of zeros to follow)	Tolerance K=±10% M=±20%	Rated DC Voltage 010=10Vdc 016=16Vdc	Packaging A = Gold Plating 7" Reel B = Gold Plating 13" Reel	Standard Suffix

TECHNICAL SPECIFICATIONS

Technical Data:	All technical data relate to an ambient temperature of +25°C		
Capacitance Range:	10 μF to 220 μF		
Capacitance Tolerance:	±10%; ±20%		
Leakage Current DCL @ V _R 25°C	0.01CV		
Leakage Current DCL @ V _C 200°C, 1000 hrs	1mA		
Rated Voltage (V _R)	≤ +85°C:	10	16
Category Voltage (V _C)	≤ +200°C:	3.3	5.3
Surge Voltage (V _S)	≤ +85°C:	13	20
Surge Voltage (V _S)	≤ +200°C:	4.3	6.5
Temperature Range:	-55°C up 200°C with voltage derating		
Reliability:	0.5% per 1000 hours at 85°C, V _R with 0.1Ω/V series impedance, 1000 hrs at 200°C, 0.33V _R		
Termination Finished:	Gold Plating Meets requirements of AEC-Q200		



THJ Series with Extension to 200°C



High Temperature Tantalum Chip Capacitor

CAPACITANCE AND RATED VOLTAGE, VR (VOLTAGE CODE) RANGE (LETTER DENOTES CASE SIZE)

Capacitance		Rated voltage (V _R) to 85°C (Voltage Code)						
µF	Code	6.3V (J)	10V (A)	16V (C)	20V (D)	25V (E)	35V (V)	50V (T)
10	106			B				
15	156							
22	226							
33	336							
47	476							
68	686							
100	107			E				
150	157		E					
220	227							
330	337							
470	477							
680	687							

Available Ratings

Engineering samples - please contact manufacturer

*Codes under development – subject to change

Note: Voltage ratings are minimum values. AVX reserves the right to supply higher ratings in the same case size, to the same reliability standards

RATINGS & PART NUMBER REFERENCE

AVX Part No.	Case Size	Cap (µF)	Rated Voltage (V)	DCL (µA) Max. @ V _R 25°C	DCL (mA) Max. @ V _c 200°C 1000hrs	DF % Max.	ESR Max. (Ω) @100kHz	MSL	100kHz RMS Current (mA)				100kHz RMS Voltage (mV)			
									25°C	85°C	175°C	200°C	25°C	85°C	175°C	200°C
10 Volt @ 85°C (3.3 Volt @ 200°C)																
THJE227*010#JH	E	220	10	22	1.0	10	0.25	1	812	731	162	81	203	183	41	20
16 Volt @ 85°C (5.3 Volt @ 200°C)																
THJB106*016#JH	B	10	16	1.6	1.0	6	2.8	1	174	157	35	17	488	439	98	49
THJE107*016#JH	E	100	16	16	1.0	8	0.25	1	812	731	162	81	203	183	41	20

Moisture Sensitivity Level (MSL) is defined according to J-STD-020.

All technical data relates to an ambient temperature of +25°C. Capacitance and DF are measured at 120Hz, 0.5V RMS with a maximum DC bias of 2.2 volts. DCL is measured at rated voltage after 5 minutes.

For typical weight and composition see page 144.

NOTE: AVX reserves the right to supply a higher voltage rating or tighter tolerance part in the same case size, to the same reliability standards.

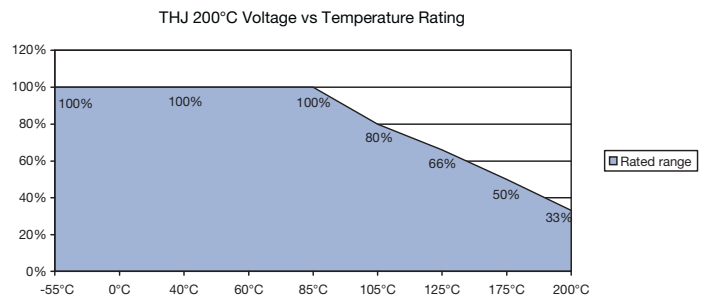

TAW Series



Tantalum Solid Electrolytic Fused Capacitors

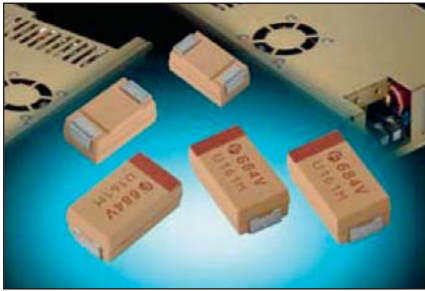

- Thin film fuse connected in series with capacitor
- Protection from possible damaging from high DC leakage current (short circuit failure)
- CV range: 6.8-100 μ F / 10-50V
- Application: servers



LEAD-FREE

LEAD-FREE COMPATIBLE COMPONENT



RoHS COMPLIANT

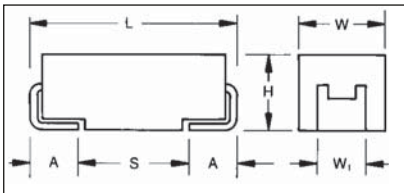

For part marking see page 151

CASE DIMENSIONS: millimeters (inches)

Code	EIA Code	EIA Metric	L \pm 0.20 (0.008)	W \pm 0.20 (0.008) -0.10 (0.004)	H \pm 0.20 (0.008) -0.10 (0.004)	W $_1$ \pm 0.20 (0.008)	A \pm 0.30 (0.012) -0.20 (0.008)	S Min.
D	2917	7343-31	7.30 (0.287)	4.30 (0.169)	2.90 (0.114)	2.40 (0.094)	1.30 (0.051)	4.40 (0.173)

W₁ dimension applies to the termination width for A dimensional area only.

HOW TO ORDER

TAW	D	476	*	010	R	0500
Type	Case Size See table above	Capacitance Code pF code: 1st two digits represent significant figures 3rd digit represents multiplier (number of zeros to follow)	Tolerance K= \pm 10% M= \pm 20%	Rated DC Voltage 010=10Vdc 016=16Vdc 020=20Vdc 025=25Vdc 035=35Vdc 050=50Vdc	Packaging R = Pure Tin 7" Reel S = Pure Tin 13" Reel	ESR in mΩ

TECHNICAL SPECIFICATIONS

Technical Data:	All technical data relate to an ambient temperature of +25°C							
Capacitance Range:	6.8 μ F to 100 μ F							
Capacitance Tolerance:	\pm 10%; \pm 20%							
Rated Voltage (V _R)	\leq +85°C:	10	16	20	25	35	50	
Category Voltage (V _C)	\leq +125°C:	7	10	13	17	23	33	
Surge Voltage (V _S)	\leq +85°C:	13	20	26	32	46	65	
Surge Voltage (V _S)	\leq +125°C:	8	13	16	20	28	40	
Fuse Off	I > 4A in 1s, insulating resistance > 10M Ω							
Fuse Continuous Current Capability	0.75A							
Temperature Range:	-55°C to +125°C							
Reliability:	1% per 1000 hours at 85°C, V _r with 0.1 Ω /V series impedance, 60% confidence level							



Tantalum Solid Electrolytic Fused Capacitors

CAPACITANCE AND RATED VOLTAGE, VR (VOLTAGE CODE) RANGE (LETTER DENOTES CASE SIZE)

Capacitance		Rated Voltage DC (V _R) to 85°C						
μF	Code	6.3V (J)	10V (A)	16V (C)	20V (D)	25V (E)	35V (V)	50V (T)
1.0	105							
2.2	225							
4.7	475							
6.8	685						D(600)	D(700)
10	106					D(600)	D(600)	D(700)
22	226				D(500)	D(600)		
33	336			D(600)	D(500)			
47	476		D(500)	D(800)				
100	107		D(500)					

Available Ratings (ESR ratings in mOhms in brackets)

Engineering samples - please contact manufacturer

*Codes under development – subject to change

Note: Voltage ratings are minimum values. AVX reserves the right to supply higher ratings in the same case size, to the same reliability standards.

RATINGS & PART NUMBER REFERENCE

AVX Part No.	Case Size	Capacitance (μF)	Rated Voltage (V)	DCL (μA) Max.	DF % Max.	ESR Max. (mΩ) @100kHz	MSL	100kHz RMS Current (mA)			100kHz RMS Voltage (mV)		
								25°C	85°C	125°C	25°C	85°C	125°C
10 Volt @ 85°C (7 Volt @ 125°C)													
TAWD476*010#0500	D	47	10	4.7	6	500	1	548	493	219	274	246	110
TAWD107*010#0500	D	100	10	10	8	500	1	548	493	219	274	246	110
16 Volt @ 85°C (10 Volt @ 125°C)													
TAWD336*016#0600	D	33	16	5.3	6	600	1	500	450	200	300	270	120
TAWD476*016#0800	D	47	16	7.5	7	800	1	433	390	173	346	312	139
20 Volt @ 85°C (13 Volt @ 125°C)													
TAWD226*020#0500	D	22	20	4.4	6	500	1	548	493	219	274	246	110
TAWD336*020#0500	D	33	20	6.6	6	500	1	548	493	219	274	246	110
25 Volt @ 85°C (17 Volt @ 125°C)													
TAWD106*025#0600	D	10	25	2.5	6	600	1	500	450	200	300	270	120
TAWD226*025#0600	D	22	25	5.5	6	600	1	500	450	200	300	270	120
35 Volt @ 85°C (23 Volt @ 125°C)													
TAWD685*035#0600	D	6.8	35	2.4	6	600	1	500	450	200	300	270	120
TAWD106*035#0600	D	10	35	3.5	6	600	1	500	450	200	300	270	120
50 Volt @ 85°C (33 Volt @ 125°C)													
TAWD685*050#0700	D	6.8	50	3.4	6	700	1	463	417	185	324	292	130
TAWD106*050#0700	D	10	50	5	6	700	1	463	417	185	324	292	130

Moisture Sensitivity Level (MSL) is defined according to J-STD-020.

All technical data relates to an ambient temperature of +25°C. Capacitance and DF are measured at 120Hz, 0.5V RMS with a maximum DC bias of 2.2 volts. DCL is measured at rated voltage after 5 minutes.

For typical weight and composition see page 144.

NOTE: AVX reserves the right to supply a higher voltage rating or tighter tolerance part in the same case size, to the same reliability standards.

TYPICAL FUSE ACTUATION

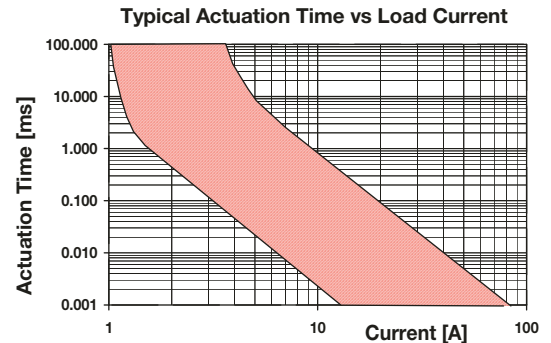

Note: for a different fuse characteristic requirements please contact manufacturer

AUDIO F95 Series



Conformal Coated Chip Optimized for Audio Applications

FRAMELESS™



- Compliant to the RoHS directive (2002/95/EC).

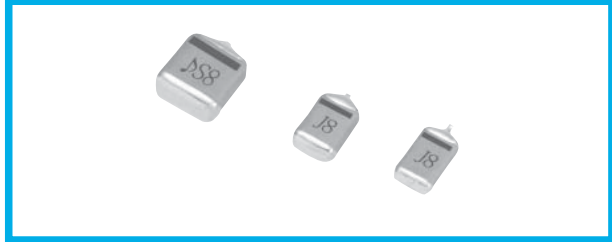

Applications

- Mobile Audio Player
- Smartphone
- Mobile phone
- Wireless Microphone System

Feature

- Rich sound in the bass register and clear sound, Materials are strictly selected to achieve high level sound. F95 series has no lead-frame, and no vibration factor.
- Low ESR, Low ESL
- Line up miniature size and high capacitance, necessary to mobile design.

Type numbering system (Example : 4V 220μF)

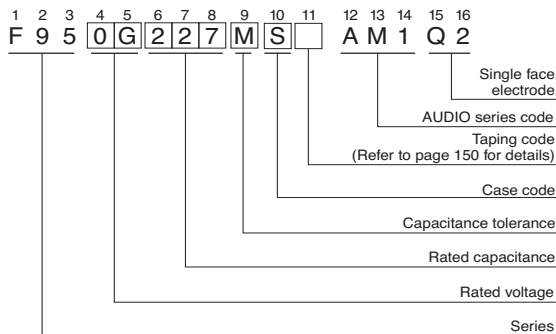

Drawing

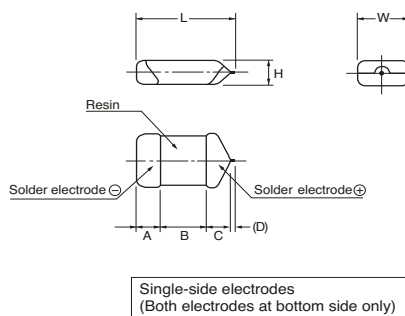

Specifications

Item	Performance Characteristics
Category	–55 to +125°C (Rated temperature : +85°C)
Temperature Range	
Capacitance Tolerance	±20%, ±10% (at 120Hz)
Dissipation Factor (at 120Hz)	Refer to next page
ESR(100kHz)	Refer to next page
Leakage Current	Refer to next page Provided that <ul style="list-style-type: none"> • After 1 minute's application of rated voltage, leakage current at 85°C, 10 times or less than 20°C specified value. • After 1 minute's application of rated voltage, leakage current at 125°C, 12.5 times or less than 20°C specified value.
Capacitance Change by Temperature	+15% Max. (at +125°C) +10% Max. (at +85°C) –10% Max. (at –55°C)
Damp Heat (Steady State)	At 40°C, 90 to 95% R.H., For 500 hours (No voltage applied) Capacitance Change Refer to next page (*1) Dissipation Factor Initial specified value or less Leakage Current Initial specified value or less
Temperature Cycles	At –55°C / +125°C, 30 minutes each, For 5 cycles, Capacitance Change Refer to next page (*1) Dissipation Factor Initial specified value or less Leakage Current Initial specified value or less
Resistance to Soldering Heat	10 seconds reflow at 260°C, 10 seconds immersion at 260°C Capacitance Change Refer to next page (*1) Dissipation Factor Initial specified value or less Leakage Current Initial specified value or less
Surge	After application of surge voltage in series with a 33Ω resistor at the rate of 30 seconds ON, 30 seconds OFF, for 1000 successive test cycles at 85°C, capacitors shall meet the characteristic requirements table below. Capacitance Change Refer to next page (*1) Dissipation Factor Initial specified value or less Leakage Current Initial specified value or less
Endurance	After 2000 hours' application of rated voltage at 85°C, capacitors shall meet the characteristic requirements table below. Capacitance Change Refer to next page (*1) Dissipation Factor Initial specified value or less Leakage Current Initial specified value or less
Shear Test	After applying the pressure load of 5N for 10±1 seconds horizontally to the center of capacitor side body which has no electrode and has been soldered beforehand on a substrate, there shall be found neither exfoliation nor its sign at the terminal electrode. 5N (0.51kg · f) For 10 ± 1 seconds
Terminal Strength	Keeping a capacitor surface-mounted on a substrate upside down and supporting the substrate at both of the opposite bottom points 45mm apart from the center of capacitor, the pressure strength is applied with a specified jig at the center of substrate so that the substrate may bend by 1mm as illustrated. Then, there shall be found no remarkable abnormality on the capacitor terminals. R230 20 45 45 1mm

Dimensions

Case code	L	W	H	A	B	C	(D)
P	2.2 ± 0.3	1.25 ± 0.3	1.0 ± 0.2	0.6 ± 0.3	0.8 ± 0.3	0.8 ± 0.3	(0.2)
S	3.2 ± 0.3	1.6 ± 0.3	1.0 ± 0.2	0.8 ± 0.3	1.2 ± 0.3	0.8 ± 0.3	(0.2)
A	3.2 ± 0.3	1.7 ± 0.3	1.4 ± 0.2	0.8 ± 0.3	1.2 ± 0.3	0.8 ± 0.3	(0.2)
T	3.5 ± 0.2	2.7 ± 0.2	1.0 ± 0.2	0.8 ± 0.2	1.2 ± 0.2	1.1 ± 0.2	(0.2)
B	3.5 ± 0.2	2.8 ± 0.2	1.8 ± 0.2	0.8 ± 0.3	1.2 ± 0.3	1.1 ± 0.3	(0.2)

D dimension only for reference

AUDIO F95 Series



Conformal Coated Chip Optimized for Audio Applications

Standard Ratings

Cap. (μF)	V	4	6.3	10
	Code	0G	0J	1A
68	686	S	S	B
100	107	S	S • T	B
150	157	S	(A)	
220	227	(P) • S • T	(A) • (T) • B	
330	337	T	B	
470	477	(T) • B	(B)	
680	687	(T) • (B)		

() The series in parentheses are being developed.
Please contact to your local AVX sales office when these series are being designed in your application.

Marking

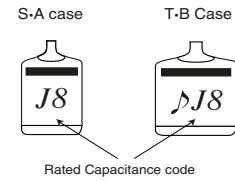

μF code	68	100	150	220	330	470	680
	W7	A8	E8	J8	N8	S8	W8

P case - No marking on part.

Standard Ratings

Rated Volt	Rated Capacitance (μF)	Case code	Part Number	*2 Leakage Current (μA)	Dissipation Factor (% @ 120Hz)	ESR (Ω @ 100kHz)	*1 ΔC/C (%)
4V	68	S	F950G686MSAAM1Q2	2.7	10	0.8	*
	100	S	F950G107MSAAM1Q2	4.0	14	0.8	*
	150	S	F950G157MSAAM1Q2	6.0	22	0.8	±15
	220	S	F950G227MSAAM1Q2	8.8	30	0.8	±15
	220	T	F950G227MTAAM1Q2	8.8	25	0.6	*
	330	T	F950G337MTAAM1Q2	13.2	40	0.8	±20
	470	B	F950G477MBAAM1Q2	18.8	40	0.4	±20
6.3V	68	S	F950J686MSAAM1Q2	4.3	14	0.9	*
	100	S	F950J107MSAAM1Q2	6.3	20	0.9	±15
	100	T	F950J107MTAAM1Q2	6.3	14	0.6	*
	220	B	F950J227MBAAM1Q2	13.9	30	0.4	*
	330	B	F950J337MBAAM1Q2	20.8	35	0.6	±20
10V	68	B	F951A686MBAAM1Q2	6.8	12	0.4	*
	100	B	F951A107MBAAM1Q2	10.0	14	0.4	*

* In case of capacitance tolerance ± 10% type, [K] will be put at 9th digit of type numbering system.

1 : ΔC/C Marked ""

Item	S • A • T • B Case (%)
Damp Heat	±10
Temperature cycles	±5
Resistance soldering heat	±5
Surge	±5
Endurance	±10

*2 : Leakage Current

After 1 minute's application of rated voltage, leakage current at 20°C.

OxiCap[®] NOJ Series



Niobium Oxide Capacitor

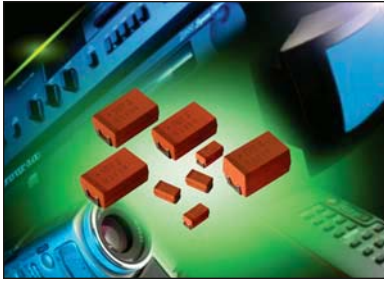

- Non-burn safe technology
- Reliability level: 0.5%/1000 hrs.
- 6 case sizes available
- Environmentally friendly
- IBM global approval received in 2004
- Electra Award received in 2005
- CV range: 4.7-1000 μ F / 1.8-10V



Electra Award
2005

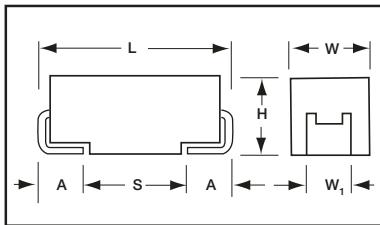

For part marking see page 151

CASE DIMENSIONS: millimeters (inches)

Code	EIA Code	EIA Metric	L \pm 0.20 (0.008)	W+0.20 (0.008) -0.10 (0.004)	H+0.20 (0.008) -0.10 (0.004)	W \pm 0.20 (0.008)	A+0.30 (0.012) -0.20 (0.008)	S Min.
A	1206	3216-18	3.20 (0.126)	1.60 (0.063)	1.60 (0.063)	1.20 (0.047)	0.80 (0.031)	1.10 (0.043)
B	1210	3528-21	3.50 (0.138)	2.80 (0.110)	1.90 (0.075)	2.20 (0.087)	0.80 (0.031)	1.40 (0.055)
C	2312	6032-28	6.00 (0.236)	3.20 (0.126)	2.60 (0.102)	2.20 (0.087)	1.30 (0.051)	2.90 (0.114)
D	2917	7343-31	7.30 (0.287)	4.30 (0.169)	2.90 (0.114)	2.40 (0.094)	1.30 (0.051)	4.40 (0.173)
E	2917	7343-43	7.30 (0.287)	4.30 (0.169)	4.10 (0.162)	2.40 (0.094)	1.30 (0.051)	4.40 (0.173)
V	2924	7361-38	7.30 (0.287)	6.10 (0.240)	3.55 (0.140)	3.10 (0.120)	1.30 (0.051)	4.40 (0.173)

W₁ dimension applies to the termination width for A dimensional area only.

HOW TO ORDER

NOJ	D	107	M	006	R	WJ	-
Type	Case Size See table above	Capacitance Code 1st two digits represent significant figures, 3rd digit represents multiplier in pF	Tolerance M= \pm 20%	Rated DC Voltage 001 = 1.8Vdc 002 = 2.5Vdc 004 = 4Vdc 006 = 6.3Vdc 010 = 10Vdc	Packaging R = Pure Tin 7" Reel S = Pure Tin 13" Reel	Specification Suffix WJ = Standard Suffix	Additional characters may be added for special requirements V = Dry pack Option (selected codes only) with exception of D, E, V cases

TECHNICAL SPECIFICATIONS

Technical Data:	All technical data relate to an ambient temperature of +25°C is not stated						
Capacitance Range:	4.7 μ F to 1000 μ F						
Capacitance Tolerance:	\pm 20%						
Leakage Current DCL:	0.02CV						
Rated Voltage DC (V _R)	\leq +85°C:	1.8	2.5	4	6.3	10	
Category Voltage (V _C)	\leq +105°C:	1.2	1.7	2.7	4	7	
Surge Voltage (V _S)	\leq +85°C:	2.3	3.3	5.2	8	13	
Surge Voltage (V _S)	\leq +105°C:	1.6	2.2	3.4	5	8	
Temperature Range:	-55°C to +105°C						
Reliability:	0.5% per 1000 hours at 85°C, V _R , 0.1 Ω /V series impedance, 60% confidence level Meets requirements of AEC-Q200						

OxiCap® NOJ Series



Niobium Oxide Capacitor

CAPACITANCE AND RATED VOLTAGE RANGE (LETTER DENOTES CASE SIZE)

Capacitance		Rated Voltage DC (V _R) to 85°C / 0.66 DC to 105°C				
μF	Code	1.8V (x)	2.5V (e)	4V (G)	6.3V (J)	10V (A)
4.7	475				A	A
6.8	685				A	A
10	106				A	A/B
15	156			A	A/B	A/B
22	226		A	A/B	A/B	B/C/B(700)
33	336		A/B	A/B	B/C/B(700)	C
47	476	A	A/B	A/B/C	B/C	C
68	686	B	B/C	B/C	B/C	C
100	107	B/C	B/C	B/C/B(250)	B/C/D/B(400)	D/D(150)
150	157	C	C	C/D	C/D	
220	227	C	C	C/D	C/D/E	V
330	337	C	C/D	D	D/E	
470	477		D/E	D/E	E/V	
680	687		E	E/V		
1000	108		V	V		

Released codes

Engineering samples - please contact manufacturer

*Codes under development - subject to change

Note: Voltage ratings are minimum values. AVX reserves the right to supply higher ratings in the same case size, to the same reliability standards.



LEAD-FREE

LEAD-FREE COMPATIBLE
COMPONENT



RoHS
COMPLIANT



NON-BURN
NON-SMOKE

Niobium Oxide Capacitor

RATINGS & PART NUMBER REFERENCE

AVX Part No.	Case Size	Capacitance (µF)	Rated Voltage (V)	DCL (µA) Max.	DF % Max.	ESR Max. (Ω) @100kHz	MSL	100kHz RMS Current (A)			100kHz RMS Voltage (V)		
								25°C	85°C	105°C	25°C	85°C	105°C
1.8 Volt @ 85°C (1.2 Volt @ 105°C)													
NOJA476M001#WJ	A	47	1.8	1.7	8	1.6	1	0.237	0.213	0.095	0.379	0.342	0.152
NOJB476M001#WJ	B	47	1.8	1.7	6	1.6	1	0.252	0.227	0.101	0.404	0.364	0.162
NOJB686M001#WJ	B	68	1.8	2.5	6	1.5	1	0.261	0.235	0.104	0.391	0.352	0.156
NOJB107M001#WJ	B	100	1.8	3.6	6	1.4	1	0.270	0.243	0.108	0.378	0.340	0.151
NOJC107M001#WJ	C	100	1.8	3.6	6	0.4	1	0.574	0.517	0.230	0.230	0.207	0.092
NOJC157M001#WJ	C	150	1.8	5.4	8	0.4	1	0.574	0.517	0.230	0.230	0.207	0.092
NOJC227M001#WJ	C	220	1.8	8.0	8	0.4	1	0.574	0.517	0.230	0.230	0.207	0.092
NOJC337M001#WJ	C	330	1.8	11.9	8	0.3	1	0.663	0.597	0.265	0.199	0.179	0.080
2.5 Volt @ 85°C (1.7 Volt @ 105°C)													
NOJA226M002#WJ	A	22	2.5	1.1	6	1.9	1	0.218	0.196	0.087	0.414	0.372	0.165
NOJA336M002#WJ	A	33	2.5	1.7	6	1.7	1	0.230	0.207	0.092	0.391	0.352	0.156
NOJB336M002#WJ	B	33	2.5	1.7	6	1.7	1	0.245	0.220	0.098	0.416	0.375	0.167
NOJA476M002#WJ	A	47	2.5	2.4	8	1.6	1	0.237	0.213	0.095	0.379	0.342	0.152
NOJB476M002#WJ	B	47	2.5	2.4	6	1.6	1	0.252	0.227	0.101	0.404	0.364	0.162
NOJB686M002#WJ	B	68	2.5	3.4	6	1.5	1	0.261	0.235	0.104	0.391	0.352	0.156
NOJC686M002#WJ	C	68	2.5	3.4	6	0.5	1	0.514	0.462	0.206	0.257	0.231	0.103
NOJB107M002#WJ	B	100	2.5	5.0	6	1.4	1	0.270	0.243	0.108	0.378	0.340	0.151
NOJC107M002#WJ	C	100	2.5	5.0	6	0.4	1	0.574	0.517	0.230	0.230	0.207	0.092
NOJC157M002#WJ	C	150	2.5	7.5	6	0.4	1	0.574	0.517	0.230	0.230	0.207	0.092
NOJC227M002#WJ	C	220	2.5	11.0	8	0.4	1	0.574	0.517	0.230	0.230	0.207	0.092
NOJC337M002#WJ	C	330	2.5	16.5	10	0.3	1	0.663	0.597	0.265	0.199	0.179	0.080
NOJD337M002#WJ	D	330	2.5	16.5	10	0.3	3	0.775	0.697	0.310	0.232	0.209	0.093
NOJD477M002#WJ	D	470	2.5	23.5	12	0.3	3	0.775	0.697	0.310	0.232	0.209	0.093
NOJE477M002#WJ	E	470	2.5	23.5	10	0.3	3	0.812	0.731	0.325	0.244	0.219	0.097
NOJE687M002#WJ	E	680	2.5	34.0	14	0.3	3	0.812	0.731	0.325	0.244	0.219	0.097
NOJV108M002#WJ	V	1000	2.5	50.0	16	0.3	3	1.000	0.900	0.400	0.300	0.270	0.120
4 Volt @ 85°C (2.7 Volt @ 105°C)													
NOJA156M004#WJ	A	15	4	1.2	6	2	1	0.212	0.191	0.085	0.424	0.382	0.170
NOJA226M004#WJ	A	22	4	1.8	6	1.9	1	0.218	0.196	0.087	0.414	0.372	0.165
NOJB226M004#WJ	B	22	4	1.8	6	1.9	1	0.232	0.209	0.093	0.440	0.396	0.176
NOJA336M004#WJ	A	33	4	2.6	10	1.7	1	0.230	0.207	0.092	0.391	0.352	0.156
NOJB336M004#WJ	B	33	4	2.6	6	1.7	1	0.245	0.220	0.098	0.416	0.375	0.167
NOJA476M004#WJ	A	47	4	3.8	18	2.2	1	0.202	0.182	0.081	0.445	0.400	0.178
NOJB476M004#WJ	B	47	4	3.8	6	1.6	1	0.252	0.227	0.101	0.404	0.364	0.162
NOJC476M004#WJ	C	47	4	3.8	6	0.5	1	0.514	0.462	0.206	0.257	0.231	0.103
NOJB686M004#WJ	B	68	4	5.4	6	1.5	1	0.261	0.235	0.104	0.391	0.352	0.156
NOJC686M004#WJ	C	68	4	5.4	6	0.5	1	0.514	0.462	0.206	0.257	0.231	0.103
NOJB107M004#WJ	B	100	4	8.0	16	1.4	1	0.270	0.243	0.108	0.378	0.340	0.151
NOJB107M004#WB	B	100	4	8.0	16	0.25	3	0.639	0.575	0.255	0.160	0.144	0.064
NOJC107M004#WJ	C	100	4	8.0	6	0.4	1	0.574	0.517	0.230	0.230	0.207	0.092
NOJC157M004#WJ	C	150	4	12.0	6	0.4	1	0.574	0.517	0.230	0.230	0.207	0.092
NOJD157M004#WJ	D	150	4	12.0	6	0.3	3	0.775	0.697	0.310	0.232	0.209	0.093
NOJC227M004#WJ	C	220	4	17.6	8	0.4	1	0.574	0.517	0.230	0.230	0.207	0.092
NOJD227M004#WJ	D	220	4	17.6	8	0.4	3	0.671	0.604	0.268	0.268	0.241	0.107
NOJD337M004#WJ	D	330	4	26.4	8	0.3	3	0.775	0.697	0.310	0.232	0.209	0.093
NOJD477M004#WJ	D	470	4	37.6	12	0.3	3	0.775	0.697	0.310	0.232	0.209	0.093
NOJE477M004#WJ	E	470	4	37.6	12	0.3	3	0.812	0.731	0.325	0.244	0.219	0.097
NOJE687M004#WJ	E	680	4	54.4	14	0.3	3	0.812	0.731	0.325	0.244	0.219	0.097
NOJV687M004#WJ	V	680	4	54.4	14	0.3	3	1.000	0.900	0.400	0.300	0.270	0.120
NOJV108M004#WJ	V	1000	4	80.0	18	0.3	3	1.000	0.900	0.400	0.300	0.270	0.120
6.3 Volt @ 85°C (4 Volt @ 105°C)													
NOJA475M006#WJ	A	4.7	6.3	1.1	6	3.2	1	0.168	0.151	0.067	0.537	0.483	0.215
NOJA685M006#WJ	A	6.8	6.3	1.1	6	2.6	1	0.186	0.167	0.074	0.484	0.435	0.193
NOJA106M006#WJ	A	10	6.3	1.2	6	2.2	1	0.202	0.182	0.081	0.445	0.400	0.178
NOJA156M006#WJ	A	15	6.3	1.8	8	2	1	0.212	0.191	0.085	0.424	0.382	0.170
NOJB156M006#WJ	B	15	6.3	1.8	6	2	1	0.226	0.203	0.090	0.452	0.406	0.181
NOJA226M006#WJ	A	22	6.3	2.6	8	1.8	1	0.224	0.201	0.089	0.402	0.362	0.161
NOJB226M006#WJ	B	22	6.3	2.6	6	1.9	1	0.232	0.209	0.093	0.440	0.396	0.176
NOJB336M006#WJ	B	33	6.3	4.0	6	1.7	1	0.245	0.220	0.098	0.416	0.375	0.167

Moisture Sensitivity Level (MSL) is defined according to J-STD-020.

All technical data relates to an ambient temperature of +25°C. Capacitance and DF are measured at 120Hz, 0.5V RMS with a maximum DC bias of 2.2 volts. DCL is measured at rated voltage after 5 minutes.

For typical weight and composition see page 144.

NOTE: AVX reserves the right to supply a higher voltage rating or tighter tolerance part in the same case size, to the same reliability standards.

OxiCap® NOJ Series



Niobium Oxide Capacitor

RATINGS & PART NUMBER REFERENCE

AVX Part No.	Case Size	Capacitance (µF)	Rated Voltage (V)	DCL (µA) Max.	DF % Max.	ESR Max. (Ω) @100kHz	MSL	100kHz RMS Current (A)			100kHz RMS Voltage (V)		
								25°C	85°C	105°C	25°C	85°C	105°C
6.3 Volt @ 85°C (4 Volt @ 105°C)													
NOJB336M006#WB	B	33	6.3	4.0	6	0.7	3	0.382	0.344	0.153	0.267	0.240	0.107
NOJC336M006#WJ	C	33	6.3	4.0	6	0.5	1	0.514	0.462	0.206	0.257	0.231	0.103
NOJB476M006#WJ	B	47	6.3	5.6	6	0.8	1	0.357	0.321	0.143	0.286	0.257	0.114
NOJC476M006#WJ	C	47	6.3	5.7	6	0.5	1	0.514	0.462	0.206	0.257	0.231	0.103
NOJB686M006#WJ	B	68	6.3	8.2	20	1.5	1	0.261	0.235	0.104	0.391	0.352	0.156
NOJC686M006#WJ	C	68	6.3	8.2	6	0.5	1	0.514	0.462	0.206	0.257	0.231	0.103
NOJB107M006#WJ	B	100	6.3	60.0	20	1.7	1	0.245	0.220	0.098	0.416	0.375	0.167
NOJB107M006#WB	B	100	6.3	60.0	20	0.4	3	0.505	0.454	0.202	0.202	0.182	0.081
NOJC107M006#WJ	C	100	6.3	12.0	8	0.4	1	0.574	0.517	0.230	0.230	0.207	0.092
NOJD107M006#WJ	D	100	6.3	12.0	6	0.4	3	0.671	0.604	0.268	0.268	0.241	0.107
NOJC157M006#WJ	C	150	6.3	18.0	6	0.4	1	0.574	0.517	0.230	0.230	0.207	0.092
NOJD157M006#WJ	D	150	6.3	18.0	6	0.4	3	0.671	0.604	0.268	0.268	0.241	0.107
NOJC227M006#WJ	C	220	6.3	26.4	14	0.4	1	0.574	0.517	0.230	0.230	0.207	0.092
NOJD227M006#WJ	D	220	6.3	26.4	8	0.4	3	0.671	0.604	0.268	0.268	0.241	0.107
NOJE227M006#WJ	E	220	6.3	26.4	12	0.4	3	0.704	0.633	0.281	0.281	0.253	0.113
NOJD337M006#WJ	D	330	6.3	39.6	10	0.3	3	0.775	0.697	0.310	0.232	0.209	0.093
NOJE337M006#WJ	E	330	6.3	39.6	12	0.3	3	0.812	0.731	0.325	0.244	0.219	0.097
NOJE477M006#WJ	E	470	6.3	56.4	16	0.3	3	0.812	0.731	0.325	0.244	0.219	0.097
NOJV477M006#WJ	V	470	6.3	56.4	14	0.3	3	1.000	0.900	0.400	0.300	0.270	0.120
10 Volt @ 85°C (7 Volt @ 105°C)													
NOJA475M010#WJ	A	4.7	10	1.0	6	3.1	1	0.170	0.153	0.068	0.528	0.475	0.211
NOJA685M010#WJ	A	6.8	10	1.4	6	2.6	1	0.186	0.167	0.074	0.484	0.435	0.193
NOJA106M010#WJ	A	10	10	2.0	6	2.2	1	0.202	0.182	0.081	0.445	0.400	0.178
NOJB106M010#WJ	B	10	10	2.0	6	1	1	0.319	0.287	0.128	0.319	0.287	0.128
NOJA156M010#WJ	A	15	10	3.0	6	2	1	0.212	0.191	0.085	0.424	0.382	0.170
NOJB156M010#WJ	B	15	10	3.0	6	2	1	0.226	0.203	0.090	0.452	0.406	0.181
NOJB226M010#WJ	B	22	10	4.4	6	1.8	1	0.238	0.214	0.095	0.428	0.386	0.171
NOJB226M010#WB	B	22	10	4.4	6	0.7	3	0.382	0.344	0.153	0.267	0.240	0.107
NOJC226M010#WJ	C	22	10	4.4	6	0.5	1	0.514	0.462	0.206	0.257	0.231	0.103
NOJC336M010#WJ	C	33	10	6.6	6	0.5	1	0.514	0.462	0.206	0.257	0.231	0.103
NOJC476M010#WJ	C	47	10	9.4	6	0.4	1	0.574	0.517	0.230	0.230	0.207	0.092
NOJC686M010#WJ	C	68	10	13.6	12	0.5	1	0.514	0.462	0.206	0.257	0.231	0.103
NOJD107M010#WJ	D	100	10	20.0	12	0.4	3	0.671	0.604	0.268	0.268	0.241	0.107
NOJD107M010#WB	D	100	10	20.0	12	0.15	3	1.095	0.986	0.438	0.164	0.148	0.066
NOJV227M010#WJ	V	220	10	44.0	12	0.4	3	0.866	0.779	0.346	0.364	0.312	0.139

Moisture Sensitivity Level (MSL) is defined according to J-STD-020.

All technical data relates to an ambient temperature of +25°C. Capacitance and DF are measured at 120Hz, 0.5V RMS with a maximum DC bias of 2.2 volts. DCL is measured at rated voltage after 5 minutes.

The EIA & CECC standards for capacitors allow an ESR movement to 1.25 times catalog limit post mounting.

For typical weight and composition see page 144.

NOTE: AVX reserves the right to supply a higher voltage rating or tighter tolerance part in the same case size, to the same reliability standards.

OxiCap® NOJ Series



Low Profile

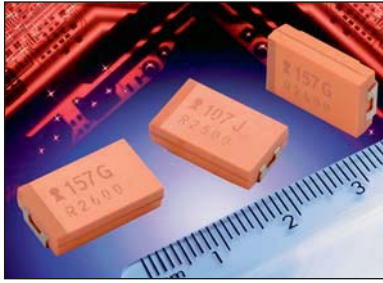

- Non-burn safe technology
- Reliability level: 0.5%/1000 hrs.
- CV range: 2.2-470µF / 1.8-10V
- 7 case sizes in low profile available
- IBM global approval received in 2004
- Electra Award received in 2005



Electra Award
2005

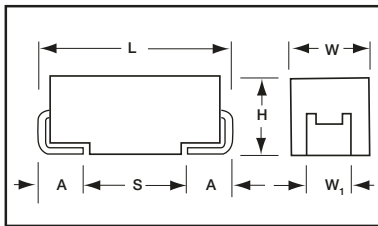

For part marking see page 151

CASE DIMENSIONS: millimeters (inches)

Code	EIA Code	EIA Metric	L±0.20 (0.008)	W+0.20 (0.008) -0.10 (0.004)	H Max	W ₁ ±0.20 (0.008)	A+0.30 (0.012) -0.20 (0.008)	S Min.
F	2312	6032-20	6.00 (0.236)	3.20 (0.126)	2.00 (0.079)	2.20 (0.087)	1.30 (0.051)	2.90 (0.114)
P	0805	2012-15	2.05 (0.081)	1.35 (0.053)	1.50 (0.059)	1.00±0.10 (0.039±0.004)	0.50 (0.020)	0.85 (0.033)
S	1206	3216-12	3.20 (0.126)	1.60 (0.063)	1.20 (0.047)	1.20 (0.047)	0.80 (0.031)	1.10 (0.043)
T	1210	3528-12	3.50 (0.138)	2.80 (0.110)	1.20 (0.047)	2.20 (0.087)	0.80 (0.031)	1.40 (0.055)
W	2312	6032-15	6.00 (0.236)	3.20 (0.126)	1.50 (0.059)	2.20 (0.087)	1.30 (0.051)	2.90 (0.114)
X	2917	7343-15	7.30 (0.287)	4.30 (0.169)	1.50 (0.059)	2.40 (0.094)	1.30 (0.051)	4.40 (0.173)
Y	2917	7343-20	7.30 (0.287)	4.30 (0.169)	2.00 (0.079)	2.40 (0.094)	1.30 (0.051)	4.40 (0.173)

W₁ dimension applies to the termination width for A dimensional area only.
Pad Stand-off is 0.1±0.1.

HOW TO ORDER

NOJ

Type

Y

Case Size
See table above

107

Capacitance Code
1st two digits represent significant figures, 3rd digit represents multiplier in pF

M

Tolerance
M=±20%

006

Rated DC Voltage
001 = 1.8Vdc
002 = 2.5Vdc
004 = 4Vdc
006 = 6.3Vdc
010 = 10Vdc

R

Packaging
R = Pure Tin 7" Reel
S = Pure Tin 13" Reel

WJ

Specification Suffix
WJ = Standard Suffix

-

Additional characters may be added for special requirements
V = Dry pack Option (selected codes only) with exception of X, Y cases

TECHNICAL SPECIFICATIONS

Technical Data:

All technical data relate to an ambient temperature of +25°C is not stated

Capacitance Range: 2.2 µF to 470 µF

Capacitance Tolerance: ±20%

Leakage Current DCL: 0.02CV

Rated Voltage DC (V _R)	≤ +85°C:	1.8	2.5	4	6.3	10
Category Voltage (V _C)	≤ +105°C:	1.2	1.7	2.7	4	7
Surge Voltage (V _S)	≤ +85°C:	2.3	3.3	5.2	8	13
Surge Voltage (V _S)	≤ +105°C:	1.6	2.2	3.4	5	8

Temperature Range: -55°C to +105°C

Reliability: 0.5% per 1000 hours at 85°C, V_R, 0.1Ω/V series impedance, 60% confidence level

Meets requirements of AEC-Q200



OxiCap® NOJ Series



Low Profile

CAPACITANCE AND RATED VOLTAGE RANGE (LETTER DENOTES CASE SIZE)

Capacitance		Rated Voltage DC (V _R) to 85°C / 0.66 DC to 105°C				
µF	Code	1.8V (x)	2.5V (e)	4V (G)	6.3V (J)	10V (A)
1.0	105					
1.5	155					
2.2	225					P
3.3	335					P
4.7	475				P/S	T
6.8	685			P/S	P/S/T	T
10	106		P/S	P/S/T	P/T	T
15	156	P/S	P/S/T	P/T		
22	226	P/S/T	P/T	T	T	
33	336	T	T	T	W	
47	476	T	T	W	W	
68	686		W	W	X/Y	
100	107	W	W	W/X	F/Y	
150	157		X	Y	F/Y	
220	227	X	Y	F/Y	Y	
330	337	Y	Y	Y		
470	477	Y				

Released codes

Engineering samples - please contact manufacturer

*Codes under development - subject to change

Note: Voltage ratings are minimum values. AVX reserves the right to supply higher ratings in the same case size, to the same reliability standards.



LEAD-FREE

LEAD-FREE COMPATIBLE
COMPONENT



RoHS
COMPLIANT



NON-BURN
NON-SMOKE

Low Profile

RATINGS & PART NUMBER REFERENCE

AVX Part No.	Case Size	Capacitance (µF)	Rated Voltage (V)	DCL (µA) Max.	DF % Max.	ESR Max. (Ω) @100kHz	MSL	100kHz RMS Current (A)			100kHz RMS Voltage (V)		
								25°C	85°C	125°C	25°C	85°C	125°C
1.8 Volt @ 85°C (1.2 Volt @ 105°C)													
NOJP156M001#WJ	P	15	1.8	1.0	10	4.1	1	0.133	0.119	0.053	0.543	0.489	0.217
NOJS156M001#WJ	S	15	1.8	1.0	6	2	1	0.197	0.178	0.079	0.395	0.335	0.158
NOJP226M001#WJ	P	22	1.8	1.0	10	3.8	1	0.138	0.124	0.055	0.523	0.471	0.209
NOJS226M001#WJ	S	22	1.8	1.0	8	1.9	1	0.203	0.182	0.081	0.385	0.346	0.154
NOJT226M001#WJ	T	22	1.8	1.0	6	1.8	1	0.231	0.208	0.092	0.416	0.374	0.166
NOJT336M001#WJ	T	33	1.8	1.2	6	1.7	1	0.238	0.214	0.095	0.404	0.364	0.162
NOJT476M001#WJ	T	47	1.8	1.7	10	1.6	1	0.245	0.220	0.098	0.392	0.353	0.157
NOJW107M001#WJ	W	100	1.8	3.6	6	0.4	1	0.520	0.468	0.208	0.208	0.187	0.083
NOJX227M001#WJ	X	220	1.8	8.0	8	0.4	3	0.548	0.493	0.219	0.219	0.197	0.088
NOJY337M001#WJ	Y	330	1.8	11.9	8	0.3	3	0.707	0.636	0.283	0.212	0.191	0.085
NOJY477M001#WJ	Y	470	1.8	17.0	8	0.3	3	0.707	0.636	0.283	0.212	0.191	0.085
2.5 Volt @ 85°C (1.7 Volt @ 105°C)													
NOJP106M002#WJ	P	10	2.5	1.0	6	4.5	1	0.126	0.114	0.051	0.569	0.512	0.228
NOJS106M002#WJ	S	10	2.5	1.0	6	2.2	1	0.188	0.169	0.075	0.414	0.373	0.166
NOJP156M002#WJ	P	15	2.5	1.0	6	4	1	0.134	0.121	0.054	0.537	0.483	0.215
NOJS156M002#WJ	S	15	2.5	1.0	8	2	1	0.197	0.178	0.079	0.395	0.355	0.158
NOJT156M002#WJ	T	15	2.5	1.0	6	2	1	0.219	0.197	0.088	0.438	0.394	0.175
NOJP226M002#WJ	P	22	2.5	1.1	10	3.8	1	0.138	0.124	0.055	0.523	0.471	0.209
NOJT226M002#WJ	T	22	2.5	1.1	6	1.9	1	0.225	0.202	0.090	0.427	0.384	0.171
NOJT336M002#WJ	T	33	2.5	1.7	6	1.7	1	0.238	0.214	0.095	0.404	0.364	0.162
NOJT476M002#WJ	T	47	2.5	2.4	10	1.6	1	0.245	0.220	0.098	0.392	0.353	0.157
NOJW686M002#WJ	W	68	2.5	3.4	6	0.4	1	0.520	0.468	0.208	0.208	0.187	0.083
NOJW107M002#WJ	W	100	2.5	5.0	6	0.4	1	0.520	0.468	0.208	0.208	0.187	0.083
NOJX157M002#WJ	X	150	2.5	7.5	6	0.4	3	0.548	0.493	0.219	0.219	0.197	0.088
NOJY227M002#WJ	Y	220	2.5	11.0	8	0.4	3	0.612	0.551	0.245	0.245	0.220	0.098
NOJY337M002#WJ	Y	330	2.5	16.5	10	0.3	3	0.707	0.636	0.283	0.212	0.191	0.085
4 Volt @ 85°C (2.7 Volt @ 105°C)													
NOJP685M004#WJ	P	6.8	4	1.0	6	5.3	1	0.117	0.105	0.047	0.618	0.556	0.247
NOJS685M004#WJ	S	6.8	4	1.0	6	2.6	1	0.173	0.156	0.069	0.450	0.405	0.180
NOJP106M004#WJ	P	10	4	1.0	20	4.5	1	0.126	0.114	0.051	0.569	0.512	0.228
NOJS106M004#WJ	S	10	4	1.0	8	2.2	1	0.188	0.169	0.075	0.414	0.373	0.166
NOJT106M004#WJ	T	10	4	1.0	6	2.2	1	0.209	0.188	0.084	0.460	0.414	0.184
NOJP156M004#WJ	P	15	4	1.2	10	4.1	1	0.133	0.119	0.053	0.543	0.489	0.217
NOJT156M004#WJ	T	15	4	1.2	6	2	1	0.219	0.197	0.088	0.438	0.394	0.175
NOJT226M004#WJ	T	22	4	1.8	6	1.8	1	0.231	0.208	0.092	0.416	0.374	0.166
NOJT336M004#WJ	T	33	4	2.6	14	2	1	0.219	0.197	0.088	0.438	0.394	0.175
NOJW476M004#WJ	W	47	4	3.8	6	0.5	1	0.465	0.418	0.186	0.232	0.209	0.093
NOJW686M004#WJ	W	68	4	5.4	6	0.4	1	0.520	0.468	0.208	0.208	0.187	0.083
NOJW107M004#WJ	W	100	4	8.0	8	0.4	1	0.520	0.468	0.208	0.208	0.187	0.083
NOJX107M004#WJ	X	100	4	8.0	6	0.4	3	0.548	0.493	0.219	0.219	0.197	0.088
NOJY157M004#WJ	Y	150	4	12.0	6	0.4	3	0.612	0.551	0.245	0.245	0.220	0.098
NOJF227M004#WJ	F	220	4	17.6	10	0.4	1	0.548	0.493	0.219	0.219	0.197	0.088
NOJY227M004#WJ	Y	220	4	17.6	10	0.4	3	0.612	0.551	0.245	0.245	0.220	0.098
NOJY337M004#WJ	Y	330	4	26.4	12	0.3	3	0.707	0.636	0.283	0.212	0.191	0.085
6.3 Volt @ 85°C (4 Volt @ 105°C)													
NOJP475M006#WJ	P	4.7	6.3	1.0	6	6.1	1	0.109	0.098	0.043	0.663	0.596	0.265
NOJS475M006#WJ	S	4.7	6.3	1.0	6	3.2	1	0.156	0.141	0.062	0.500	0.450	0.200
NOJP685M006#WJ	P	6.8	6.3	1.0	10	5.2	1	0.118	0.106	0.047	0.612	0.551	0.245
NOJS685M006#WJ	S	6.8	6.3	1.0	8	2.7	1	0.170	0.153	0.068	0.459	0.413	0.184
NOJT685M006#WJ	T	6.8	6.3	1.0	6	2.6	1	0.192	0.173	0.077	0.500	0.450	0.200
NOJP106M006#WJ	P	10	6.3	1.2	10	4.5	1	0.126	0.114	0.051	0.569	0.512	0.228
NOJT106M006#WJ	T	10	6.3	1.2	6	2.2	1	0.209	0.188	0.084	0.460	0.414	0.184
NOJT226M006#WJ	T	22	6.3	2.6	8	1.8	1	0.231	0.208	0.092	0.416	0.374	0.166
NOJW336M006#WJ	W	33	6.3	4.0	6	0.5	1	0.465	0.418	0.186	0.232	0.209	0.093
NOJW476M006#WJ	W	47	6.3	5.7	6	0.5	1	0.465	0.418	0.186	0.232	0.209	0.093
NOJX686M006#WJ	X	68	6.3	8.2	6	0.5	3	0.490	0.441	0.196	0.245	0.220	0.098
NOJY686M006#WJ	Y	68	6.3	8.2	6	0.5	3	0.548	0.493	0.219	0.274	0.246	0.110
NOJF107M006#WJ	F	100	6.3	12	8	0.4	1	0.548	0.493	0.219	0.219	0.197	0.088
NOJY107M006#WJ	Y	100	6.3	12.0	6	0.4	3	0.612	0.551	0.245	0.245	0.220	0.098
NOJF157M006#WJ	F	150	6.3	18.0	8	0.4	1	0.548	0.493	0.219	0.219	0.197	0.088
NOJY157M006#WJ	Y	150	6.3	18.0	6	0.4	3	0.612	0.551	0.245	0.245	0.220	0.098
NOJY227M006#WJ	Y	220	6.3	26.4	10	0.4	3	0.612	0.551	0.245	0.245	0.220	0.098
10 Volt @ 85°C (7 Volt @ 105°C)													
NOJP225M010#WJ	P	2.2	10	1.0	8	8.3	1	0.093	0.084	0.037	0.773	0.696	0.309
NOJP335M010#WJ	P	3.3	10	1.0	8	7	1	0.101	0.091	0.041	0.710	0.639	0.284
NOJT475M010#WJ	T	4.7	10	1.0	6	3.1	1	0.176	0.158	0.070	0.546	0.491	0.218
NOJT685M010#WJ	T	6.8	10	1.4	6	2.6	1	0.192	0.173	0.077	0.500	0.450	0.200
NOJT106M010#WJ	T	10	10	2.0	6	2.2	1	0.209	0.188	0.084	0.460	0.414	0.184

Moisture Sensitivity Level (MSL) is defined according to J-STD-020.

All technical data relates to an ambient temperature of +25°C. Capacitance and DF are measured at 120Hz, 0.5V RMS with a maximum DC bias of 2.2 volts.

DCL is measured at rated voltage after 5 minutes.

The EIA & CECC standards for capacitors allow an ESR movement to 1.25 times catalog limit post mounting.

For typical weight and composition see page 144.

NOTE: AVX reserves the right to supply a higher voltage rating or tighter tolerance part in the same case size, to the same reliability standards.

OxiCap® NLJ Series



Niobium Oxide Capacitors High CV Consumer Series



- High Volumetric efficiency
- Environmentally friendly
- 3xreflow 260°C compatible
- Consumer applications
- OxiCap® non-burn technology
- RoHS compliance
- Lead-free solution
- 6 case sizes available
- CV range: 22-150µF / 4-10V



Elektra Award
2005

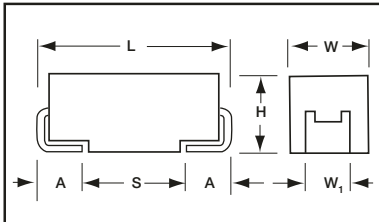

For part marking see page 151

CASE DIMENSIONS: millimeters (inches)

Code	EIA Code	EIA Metric	L±0.20 (0.008)	W+0.20 (0.008) -0.10 (0.004)	H+0.20 (0.008) -0.10 (0.004)	W ₁ ±0.20 (0.008)	A+0.30 (0.012) -0.20 (0.008)	S Min.
A	1206	3216-18	3.20 (0.126)	1.60 (0.063)	1.60 (0.063)	1.20 (0.047)	0.80 (0.031)	1.10 (0.043)
B	1210	3528-21	3.50 (0.138)	2.80 (0.110)	1.90 (0.075)	2.20 (0.087)	0.80 (0.031)	1.40 (0.055)
C	2312	6032-28	6.00 (0.236)	3.20 (0.126)	2.60 (0.102)	2.20 (0.087)	1.30 (0.051)	2.90 (0.114)
D	2917	7343-31	7.30 (0.287)	4.30 (0.169)	2.90 (0.114)	2.40 (0.094)	1.30 (0.051)	4.40 (0.173)
G	1206	3216-15	3.20 (0.126)	1.60 (0.063)	1.50 (0.059) max	1.20 (0.047)	0.80 (0.031)	1.10 (0.043)
P	0805	2012-15	2.05 (0.081)	1.35 (0.053)	1.50 (0.059) max	1.00±0.10 (0.039±0.004)	0.50 (0.020)	0.85 (0.033)
S	1206	3216-12	3.20 (0.126)	1.60 (0.063)	1.20 (0.047) max	1.20 (0.047)	0.80 (0.031)	1.10 (0.043)
T	1210	3528-12	3.50 (0.138)	2.80 (0.110)	1.20 (0.047) max	2.20 (0.087)	0.80 (0.031)	1.40 (0.055)
W	2312	6032-15	6.00 (0.236)	3.20 (0.126)	1.50 (0.059) max	2.20 (0.087)	1.30 (0.051)	2.90 (0.114)
Y	2917	7343-20	7.30 (0.287)	4.30 (0.169)	2.00 (0.079) max	2.40 (0.094)	1.30 (0.051)	4.40 (0.173)

W₁ dimension applies to the termination width for A dimensional area only.

HOW TO ORDER

NLJ	A	476	M	006	R	1600
Type	Case Size See table above	Capacitance Code 1st two digits represent significant figures, 3rd digit represents multiplier in pF	Tolerance M=±20%	Rated DC Voltage 004 = 4Vdc 006 = 6.3Vdc 010 = 10Vdc	Packaging R = Pure Tin 7" Reel S = Pure Tin 13" Reel	ESR in mΩ

Under development

TECHNICAL SPECIFICATIONS

Technical Data:	All technical data relate to an ambient temperature of +25°C				
Capacitance Range:	6.8 µF to 1000 µF				
Capacitance Tolerance:	±20%				
Leakage Current DCL:	0.1CV				
Rated Voltage DC (V _R)	-55°C ≤ +40°C:	4	6.3	10	
Category Voltage (V _C)	at 85°C:	2	3.15	5	
Category Voltage (V _C)	at 105°C:	1.32	2	3.3	
Temperature Range:	-55°C to +105°C with category voltage				
Reliability:	0.2% per 1000 hours at 85°C, 0.5xV _R , 0.1Ω/V series impedance with 60% confidence level				



OxiCap® NLJ Series



Niobium Oxide Capacitors High CV Consumer Series

CAPACITANCE AND RATED VOLTAGE RANGE (LETTER DENOTES CASE SIZE)

Capacitance		Rated Voltage DC to 40°C / 0.5DC to 85°C / 0.33DC to 105°C		
µF	Code	4V (G)	6.3V (J)	10V (A)
6.8	685			K(4000)*/P(5000)*
10	106		K(4000)*	K(2200)*/P(6000)*
15	156	K(4000)*/P(4000)*	P(3500)*	L(2800)*/S(2000)*
22	226	P(4000)	L(2500)*/S(1800)	A(4000)/G(3000) L(2200)*
33	336	A(3000)*/S(1700)*	G(2200)/L(2500)*	A(1700)/T(1800)*
47	476	A(2600)*/G(2600)* L(1600)*	A(1600)/T(1600)	B(1000)/H(1000)* W(400)*
68	686	A(1500)*/T(1500)*	H(900)*	B(1400)*
100	107	H(900)*	B(1700)/W(600)*	C(1200)*/Y(1200)*
150	157	B(1500)/W(400)*		
220	227			D(1000)*
330	337		C(500)*/Y(500)*	
470	477	C(500)*/Y(500)*		
680	687		D(500)*	
1000	108	D(500)*		



LEAD-FREE

LEAD-FREE COMPATIBLE
COMPONENT



RoHS
COMPLIANT



NON-BURN
NON-SMOKE

Available Ratings, (ESR ratings in mOhms in brackets)

Engineering samples - please contact manufacturer

*Codes under development - subject to change

Note: Voltage ratings are minimum values. AVX reserves the right to supply higher ratings in the same case size, to the same reliability standards.

RATINGS & PART NUMBER REFERENCE

AVX Part No.	Case Size	Capacitance (µF)	Rated Voltage (V)	Maximum Surge Current (A)*	DCL (µA) Max.	ESR Max. (mΩ) @100kHz	MSL	100kHz Ripple Current (mA)			100kHz Ripple Voltage (mV)		
								25°C	85°C	105°C	25°C	85°C	105°C
4 Volt @ 85°C (1.32 Volt @ 105°C)													
NLJP226M004#4000	P	22	4	0.4	8.8	4000	3	134	121	54	537	483	215
NLJB157M004#1500	B	150	4	1.0	60.0	1500	3	261	235	104	391	352	156
NLJW157M004#0400	W	150	4	2.4	60.0	400	3	520	468	208	208	187	83
NLJC477M004#0500	C	470	4	2.1	188.0	500	3	514	462	206	257	231	103
NLJY477M004#0500	Y	470	4	2.1	188.0	500	3	548	493	219	274	246	110
NLJD108M004#0500	D	1000	4	2.1	400.0	500	3	600	540	240	300	270	120
6.3 Volt @ 85°C (2 Volt @ 105°C)													
NLJS226M006#1800	S	22	6.3	1.4	13.2	1800	3	208	187	83	375	337	150
NLJG336M006#2200	G	33	6.3	1.2	19.8	2200	3	195	176	78	430	387	172
NLJA476M006#1600	A	47	6.3	1.5	28.2	1600	3	237	213	98	379	342	152
NLJT476M006#1600	T	47	6.3	1.5	28.2	1600	3	245	220	98	392	353	157
NLJB107M006#1700	B	100	6.3	1.5	60.0	1700	3	245	220	98	416	375	167
NLJW107M006#0600	W	100	6.3	3.0	60.0	600	3	424	382	170	255	229	102
NLJC337M006#0500	C	330	6.3	3.3	198.0	500	3	514	462	206	257	231	103
NLJY337M006#0500	Y	330	6.3	3.3	198.0	500	3	548	493	219	274	246	110
NLJD687M006#0500	D	680	6.3	3.3	408.0	500	3	600	540	240	300	270	120
10 Volt @ 85°C (3.3 Volt @ 105°C)													
NLJA226M010#4000	A	22	10	1.1	22.0	4000	3	150	135	60	600	540	240
NLJG226M010#3000	G	22	10	1.4	22.0	3000	3	167	151	67	502	452	201
NLJA336M010#1700	A	33	10	2.3	33.0	1700	3	230	207	92	391	352	156
NLJB476M010#1000	B	47	10	3.4	47.0	1000	3	319	287	128	319	287	128
NLJW476M010#0400	W	47	10	5.9	47.0	400	3	520	468	208	208	187	83
NLJC107M010#1200	C	100	10	3.0	100.0	1200	3	332	298	133	398	358	159
NLJY107M010#1200	Y	100	10	3.0	100.0	1200	3	354	318	141	424	382	170
NLJD227M010#1000	D	220	10	3.4	220.0	1000	3	424	382	170	424	382	170

Moisture Sensitivity Level (MSL) is defined according to J-STD-020.

All technical data relates to an ambient temperature of +25°C. Capacitance and DF are measured at 120Hz, 0.5V RMS with a maximum DC bias of 2.2 volts. DCL is measured at rated voltage after 5 minutes.

ESR allowed to move up to 1.25 times catalogue limit post mounting

DCL allowed to move up to 2.00 times catalogue limit post mounting

For typical weight and composition see page 144.

NOTE: AVX reserves the right to supply a higher voltage rating or tighter tolerance part in the same case size, to the same reliability standards.

Voltage vs Temperature Rating

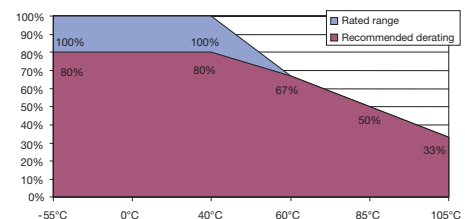

OxiCap[®] NOS Low ESR Series



Niobium Oxide Capacitor



- Low ESR NbO capacitors
- Non-burn safe technology
- Reliability level: 0.2%/1000 hrs.
- CV range: 10-1000 μ F / 1.8-6.3V
- 9 case sizes available
- IBM global approval received in 2004
- Electra Award received in 2005



Electra Award
2005

CASE DIMENSIONS: millimeters (inches)

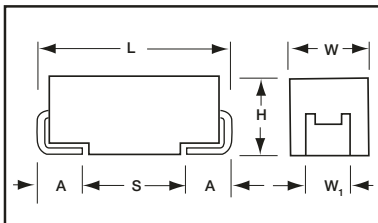

For part marking see page 151

Code	EIA Code	EIA Metric	L \pm 0.20 (0.008)	W+0.20 (0.008) -0.10 (0.004)	H+0.20 (0.008) -0.10 (0.004)	W ₁ \pm 0.20 (0.008)	A+0.30 (0.012) -0.20 (0.008)	S Min.
A	1206	3216-18	3.20 (0.126)	1.60 (0.063)	1.60 (0.063)	1.20 (0.047)	0.80 (0.031)	1.10 (0.043)
B	1210	3528-21	3.50 (0.138)	2.80 (0.110)	1.90 (0.075)	2.20 (0.087)	0.80 (0.031)	1.40 (0.055)
C	2312	6032-28	6.00 (0.236)	3.20 (0.126)	2.60 (0.102)	2.20 (0.087)	1.30 (0.051)	2.90 (0.114)
D	2917	7343-31	7.30 (0.287)	4.30 (0.169)	2.90 (0.114)	2.40 (0.094)	1.30 (0.051)	4.40 (0.173)
E	2917	7343-43	7.30 (0.287)	4.30 (0.169)	4.10 (0.162)	2.40 (0.094)	1.30 (0.051)	4.40 (0.173)
V	2924	7361-38	7.30 (0.287)	6.10 (0.240)	3.55 (0.140)	3.10 (0.120)	1.30 (0.051)	4.40 (0.173)
W	2312	6032-15	6.00 (0.236)	3.20 (0.126)	1.50 (0.059) max.	2.20 (0.087)	1.30 (0.051)	2.90 (0.114)
X	2917	7343-15	7.30 (0.287)	4.30 (0.169)	1.50 (0.059) max.	2.40 (0.094)	1.30 (0.051)	4.40 (0.173)
Y	2917	7343-20	7.30 (0.287)	4.30 (0.169)	2.00 (0.079) max.	2.40 (0.094)	1.30 (0.051)	4.40 (0.173)

W₁ dimension applies to the termination width for A dimensional area only.

HOW TO ORDER

NOS	D	107	M	006	R	0100	-
Type	Case Size See table above	Capacitance Code 1st two digits represent significant figures, 3rd digit represents multiplier in pF	Tolerance M=±20%	Rated DC Voltage 001 = 1.8Vdc 002 = 2.5Vdc 004 = 4Vdc 006 = 6.3Vdc	Packaging R = Pure Tin 7" Reel S = Pure Tin 13" Reel	ESR in mΩ	Additional characters may be added for special requirements V = Dry pack Option (selected codes only) with exception of D, E, X, Y, V cases

TECHNICAL SPECIFICATIONS

Technical Data:	All technical data relate to an ambient temperature of +25°C is not stated				
Capacitance Range:	10 μ F to 1000 μ F				
Capacitance Tolerance:	±20%				
Leakage Current DCL:	0.02CV				
Rated Voltage DC (V _R)	≤ +85°C:	1.8	2.5	4	6.3
Category Voltage (V _C)	≤ +125°C:	0.9	1.3	2	3
Surge Voltage (V _S)	≤ +85°C:	2.3	3.3	5.2	8
Surge Voltage (V _S)	≤ +125°C:	1.2	1.7	2.6	4
Temperature Range:	-55°C to +125°C				
Reliability:	0.2% per 1000 hours at 85°C, V _R , 0.1 Ω /V series impedance, 60% confidence level Meets requirements of AEC-Q200				

OxiCap® NOS Low ESR Series



Niobium Oxide Capacitor

CAPACITANCE AND RATED VOLTAGE RANGE (LETTER DENOTES CASE SIZE)

Capacitance		Rated Voltage DC (V _R) to 85°C / 0.66 DC to 105°C / 0.5 DC to 125°C			
µF	Code	1.8V (x)	2.5V (e)	4.0V (G)	6.3V (J)
4.7	475				
6.8	685				
10	106				A(800, 1000, 2000)
15	156			A(1500)	B(600)
22	226		A(900)	B(600)	B(600)
33	336			B(600)	B(600) C(500) W(250)
47	476		B(500)	B(500) C(300) W(150)	B(500) C(300)
68	686		C(200) W(150)	C(200)	C(75,200) X(100) Y(100)
100	107	B(350) W(150)	C(150)	C(70,150) X(100)	C(150) D(80,100) Y(100)
150	157		C(65,150) X(100)	C(90,150) Y(100)	D(50,70,100) Y(100)
220	227	C(125) X(100)	C(80,125) Y(100)	D(40,60,100) Y(100)	D(45,60,100) E(80,100)
330	337	Y(100)	D(35,50,100) Y(100)	D(35,55,100) E(100)/Y(150)	E(80,100)
470	477	Y(100)	D(35,55,100) E(100)	D(100) E(75,100)	E(75)/V(75)
680	687		E(60)	V(75)	
1000	108		V(50)		



LEAD-FREE

LEAD-FREE COMPATIBLE
COMPONENT



RoHS
COMPLIANT



NON-BURN
NON-SMOKE

Available Ratings, (ESR ratings in mOhms in brackets)

Engineering samples - please contact manufacturer

*Codes under development - subject to change

Note: Voltage ratings are minimum values. AVX reserves the right to supply higher ratings in the same case size, to the same reliability standards.

OxiCap® NOS Low ESR Series



Niobium Oxide Capacitor

RATINGS & PART NUMBER REFERENCE

AVX Part No.	Case Size	Capacitance (µF)	Rated Voltage (V)	DCL (µA) Max.	DF % Max.	ESR Max. (mΩ) @100kHz	MSL	100kHz RMS Current (A)			100kHz RMS Voltage (V)		
								25°C	85°C	125°C	25°C	85°C	125°C
1.8 Volt @ 85°C (1.2 Volt @ 105°C, 0.9 Volt @ 125°C)													
NOSB107M001#0350	B	100	1.8	3.6	6	350	1	0.540	0.486	0.216	0.189	0.170	0.076
NOSW107M001#0150	W	100	1.8	3.6	6	150	1	0.849	0.764	0.339	0.127	0.115	0.051
NOSC227M001#0125	C	220	1.8	8.0	8	125	1	1.028	0.925	0.411	0.128	0.116	0.051
NOSX227M001#0100	X	220	1.8	8.0	8	100	3	1.095	0.986	0.438	0.110	0.099	0.044
NOSY337M001#0100	Y	330	1.8	11.9	8	100	3	1.225	1.102	0.490	0.122	0.110	0.049
NOSY477M001#0100	Y	470	1.8	17.0	8	100	3	1.225	1.102	0.490	0.122	0.110	0.049
2.5 Volt @ 85°C (1.7 Volt @ 105°C, 1.3 Volt @ 125°C)													
NOSA226M002#0900	A	22	2.5	1.1	6	900	1	0.316	0.285	0.126	0.285	0.256	0.114
NOSB476M002#0500	B	47	2.5	2.4	6	500	1	0.452	0.406	0.181	0.226	0.203	0.090
NOSB686M002#0200	C	68	2.5	3.4	6	200	1	0.812	0.731	0.325	0.162	0.146	0.065
NOSW686M002#0150	W	68	2.5	3.4	6	150	1	0.849	0.764	0.339	0.127	0.115	0.051
NOSC107M002#0150	C	100	2.5	5.0	6	150	1	0.938	0.844	0.375	0.141	0.127	0.056
NOSC157M002#0065	C	150	2.5	7.5	6	65	1	1.425	1.283	0.570	0.093	0.083	0.037
NOSC157M002#0150	C	150	2.5	7.5	6	150	1	0.938	0.844	0.375	0.141	0.127	0.056
NOSX157M002#0100	X	150	2.5	7.5	6	100	3	1.095	0.986	0.438	0.110	0.099	0.044
NOSC227M002#0080	C	220	2.5	11.0	8	80	1	1.285	1.156	0.514	0.103	0.092	0.041
NOSC227M002#0125	C	220	2.5	11.0	8	125	1	1.028	0.925	0.411	0.128	0.116	0.051
NOSY227M002#0100	Y	220	2.5	11.0	8	100	3	1.225	1.102	0.490	0.122	0.110	0.049
NOSD337M002#0035	D	330	2.5	16.5	10	35	3	2.268	2.041	0.907	0.079	0.071	0.032
NOSD337M002#0050	D	330	2.5	16.5	10	50	3	1.897	1.708	0.759	0.095	0.085	0.038
NOSD337M002#0100	D	330	2.5	16.5	10	100	3	1.342	1.207	0.537	0.134	0.121	0.054
NOSY337M002#0100	Y	330	2.5	16.5	10	100	3	1.225	1.102	0.490	0.122	0.110	0.049
NOSD477M002#0035	D	470	2.5	23.5	12	35	3	2.268	2.041	0.907	0.079	0.071	0.032
NOSD447M002#0055	D	470	2.5	23.5	12	55	3	1.809	1.628	0.724	0.099	0.090	0.040
NOSD447M002#0100	D	470	2.5	23.5	12	100	3	1.342	1.207	0.537	0.134	0.121	0.054
NOSE477M002#0100	E	470	2.5	23.5	10	100	3	1.407	1.266	0.563	0.141	0.127	0.056
NOSE687M002#0060	E	680	2.5	34.0	14	60	3	1.817	1.635	0.727	0.109	0.098	0.044
NOSV108M002#0050	V	1000	2.5	50.0	16	50	3	2.449	2.205	0.980	0.122	0.110	0.049
4 Volt @ 85°C (2.6 Volt @ 105°C, 2 Volt @ 125°C)													
NOSA156M004#1500	A	15	4	1.2	6	1500	1	0.245	0.220	0.098	0.367	0.331	0.147
NOSB226M004#0600	B	22	4	1.8	6	600	1	0.412	0.371	0.165	0.247	0.223	0.099
NOSB336M004#0600	B	33	4	2.6	6	600	1	0.412	0.371	0.165	0.247	0.223	0.099
NOSB476M004#0500	B	47	4	3.8	6	500	1	0.452	0.406	0.181	0.226	0.203	0.090
NOSC476M004#0300	C	47	4	3.8	6	300	1	0.663	0.597	0.265	0.199	0.179	0.080
NOSW476M004#0150	W	47	4	3.8	6	150	1	0.849	0.764	0.339	0.127	0.115	0.051
NOSC686M004#0200	C	68	4	5.4	6	200	1	0.812	0.731	0.325	0.162	0.146	0.065
NOSC107M004#0070	C	100	4	8.0	6	70	1	1.373	1.236	0.549	0.096	0.087	0.038
NOSC107M004#0150	C	100	4	8.0	6	150	1	0.938	0.844	0.375	0.141	0.127	0.056
NOSX107M004#0100	X	100	4	8.0	6	100	3	1.095	0.986	0.438	0.110	0.099	0.044
NOSC157M004#0090	C	150	4	12.0	6	90	1	1.211	1.090	0.484	0.109	0.098	0.044
NOSC157M004#0150	C	150	4	12.0	6	150	1	0.938	0.844	0.375	0.141	0.127	0.056
NOSY157M004#0100	Y	150	4	12.0	6	100	3	1.225	1.102	0.490	0.122	0.110	0.049
NOSD227M004#0040	D	220	4	17.6	8	40	3	2.121	1.909	0.849	0.085	0.076	0.034
NOSD227M004#0060	D	220	4	17.6	8	60	3	1.732	1.559	0.693	0.104	0.094	0.042
NOSD227M004#0100	D	220	4	17.6	8	100	3	1.342	1.207	0.537	0.134	0.121	0.054
NOSY227M004#0100	Y	220	4	17.6	10	100	3	1.225	1.102	0.490	0.122	0.110	0.049
NOSD337M004#0035	D	330	4	26.4	8	35	3	2.268	2.041	0.907	0.079	0.071	0.032
NOSD337M004#0055	D	330	4	26.4	8	55	3	1.809	1.628	0.724	0.099	0.090	0.040
NOSD337M004#0100	D	330	4	26.4	8	100	3	1.342	1.207	0.537	0.134	0.121	0.054
NOSE337M004#0100	E	330	4	26.4	8	100	3	1.407	1.266	0.563	0.141	0.127	0.056
NOSY337M004#0150	Y	330	4	26.4	12	150	3	1.000	0.900	0.400	0.150	0.135	0.060
NOSD477M004#0100	D	470	4	37.6	12	100	3	1.342	1.207	0.537	0.134	0.121	0.054
NOSE477M004#0075	E	470	4	37.6	12	75	3	1.625	1.462	0.650	0.122	0.110	0.049
NOSE477M004#0100	E	470	4	37.6	12	100	3	1.407	1.266	0.563	0.141	0.127	0.056
NOSV687M004#0075	V	680	4	54.4	14	75	3	2.000	1.800	0.800	0.150	0.135	0.060

Moisture Sensitivity Level (MSL) is defined according to J-STD-020.

All technical data relates to an ambient temperature of +25°C. Capacitance and DF are measured at 120Hz, 0.5V RMS with a maximum DC bias of 2.2 volts. DCL is measured at rated voltage after 5 minutes.

ESR allowed to move, up to 1.25 times catalog limit post mounting.

For typical weight and composition see page 144.

NOTE: AVX reserves the right to supply a higher voltage rating or tighter tolerance part in the same case size, to the same reliability standards.

OxiCap® NOS Low ESR Series



Niobium Oxide Capacitor

RATINGS & PART NUMBER REFERENCE

AVX Part No.	Case Size	Capacitance (µF)	Rated Voltage (V)	DCL (µA) Max.	DF % Max.	ESR Max. (mΩ) @100kHz	MSL	100kHz RMS Current (A)			100kHz RMS Voltage (V)		
								25°C	85°C	125°C	25°C	85°C	125°C
6.3 Volt @ 85°C (4 Volt @ 105°C, 3 Volt @ 125°C)													
NOSA106M006#0800	A	10	6.3	1.2	6	800	1	0.335	0.302	0.134	0.268	0.241	0.107
NOSA106M006#1000	A	10	6.3	1.2	6	1000	1	0.300	0.270	0.120	0.300	0.270	0.120
NOSA106M006#2000	A	10	6.3	1.2	6	2000	1	0.212	0.191	0.085	0.424	0.382	0.170
NOSB156M006#0600	B	15	6.3	1.8	6	600	1	0.412	0.371	0.165	0.247	0.223	0.099
NOSB226M006#0600	B	22	6.3	2.6	6	600	1	0.412	0.371	0.165	0.247	0.223	0.099
NOSB336M006#0600	B	33	6.3	4.0	6	600	1	0.412	0.371	0.165	0.247	0.223	0.099
NOSC336M006#0500	C	33	6.3	4.0	6	500	1	0.514	0.462	0.206	0.257	0.231	0.103
NOSW336M006#0250	W	33	6.3	4.0	6	250	1	0.657	0.592	0.263	0.164	0.148	0.066
NOSB476M006#0500	B	47	6.3	5.6	6	500	1	0.452	0.406	0.181	0.226	0.203	0.090
NOSC476M006#0300	C	47	6.3	5.7	6	300	1	0.663	0.597	0.265	0.199	0.179	0.080
NOSC686M006#0075	C	68	6.3	8.2	6	75	1	1.327	1.194	0.531	0.099	0.090	0.040
NOSC686M006#0200	C	68	6.3	8.2	6	200	1	0.812	0.731	0.325	0.162	0.146	0.065
NOSX686M006#0100	X	68	6.3	8.2	6	100	3	1.095	0.986	0.438	0.110	0.099	0.044
NOSY686M006#0100	Y	68	6.3	8.2	6	100	3	1.225	1.102	0.490	0.122	0.110	0.049
NOSC107M006#0150	C	100	6.3	12.0	8	150	1	0.938	0.844	0.375	0.141	0.127	0.056
NOSD107M006#0080	D	100	6.3	12.0	6	80	3	1.500	1.350	0.600	0.120	0.108	0.048
NOSD107M006#0100	D	100	6.3	12.0	6	100	3	1.342	1.207	0.537	0.134	0.121	0.054
NOSY107M006#0100	Y	100	6.3	12.0	6	100	3	1.225	1.102	0.490	0.122	0.110	0.049
NOSD157M006#0050	D	150	6.3	18.0	6	50	3	1.897	1.708	0.759	0.095	0.085	0.038
NOSD157M006#0070	D	150	6.3	18.0	6	70	3	1.604	1.443	0.641	0.112	0.101	0.045
NOSD157M006#0100	D	150	6.3	18.0	6	100	3	1.342	1.207	0.537	0.134	0.121	0.054
NOSY157M006#0100	Y	150	6.3	18.0	6	100	3	1.225	1.102	0.490	0.122	0.110	0.049
NOSD227M006#0045	D	220	6.3	26.4	8	45	3	2.000	1.800	0.800	0.090	0.081	0.036
NOSD227M006#0060	D	220	6.3	26.4	8	60	3	1.732	1.559	0.693	0.104	0.094	0.042
NOSD227M006#0100	D	220	6.3	26.4	8	100	3	1.342	1.207	0.537	0.134	0.121	0.054
NOSE227M006#0080	E	220	6.3	26.4	12	80	3	1.573	1.416	0.629	0.126	0.113	0.050
NOSE227M006#0100	E	220	6.3	26.4	12	100	3	1.407	1.266	0.563	0.141	0.127	0.056
NOSE337M006#0080	E	330	6.3	39.6	12	80	3	1.573	1.416	0.629	0.126	0.113	0.050
NOSE337M006#0100	E	330	6.3	39.6	12	100	3	1.407	1.266	0.563	0.141	0.127	0.056
NOSE477M006#0075	E	470	6.3	56.4	16	75	3	1.625	1.462	0.650	0.122	0.110	0.049
NOSV477M006#0075	V	470	6.3	56.4	14	75	3	2.000	1.800	0.800	0.150	0.135	0.060

Moisture Sensitivity Level (MSL) is defined according to J-STD-020.

All technical data relates to an ambient temperature of +25°C. Capacitance and DF are measured at 120Hz, 0.5V RMS with a maximum DC bias of 2.2 volts. DCL is measured at rated voltage after 5 minutes.

The EIA & CECC standards for low ESR Solid Tantalum Capacitors allow an ESR movement to 1.25 times catalogue limit post mounting.

For typical weight and composition see page 144.

NOTE: AVX reserves the right to supply a higher voltage rating or tighter tolerance part in the same case size, to the same reliability standards.

OxiCap[®] NOM Low ESR Multianodes



Niobium Oxide Capacitor

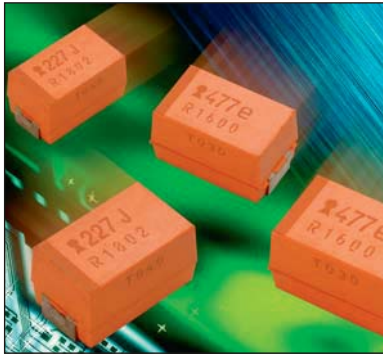

- Multi-anode construction
- Super low ESR
- Non-burn safe technology
- CV range: 220-680 μ F / 1.8-6.3V
- IBM global approval received in 2004
- Electra award received in 2005



Electra Award
2005

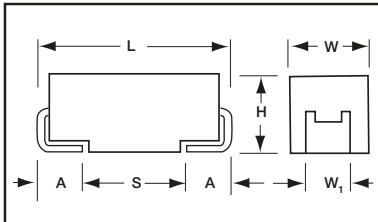

For part marking see page 151

CASE DIMENSIONS: millimeters (inches)

Code	EIA Code	EIA Metric	L \pm 0.20 (0.008)	W \pm 0.20 (0.008) -0.10 (0.004)	H \pm 0.20 (0.008) -0.10 (0.004)	W \pm 0.20 (0.008) (0.008)	A \pm 0.30 (0.012) -0.20 (0.008)	S Min.
E	2917	7343-43	7.30 (0.287)	4.30 (0.169)	4.10 (0.162)	2.40 (0.094)	1.30 (0.051)	4.40 (0.173)

W₁ dimension applies to the termination width for A dimensional area only.

HOW TO ORDER

NOM

Type

E

Case Size
See table above

227

Capacitance Code
1st two digits represent significant figures, 3rd digit represents multiplier in pF

M

Tolerance
M \pm 20%

006

Rated DC Voltage
001 = 1.8Vdc
002 = 2.5Vdc
004 = 4Vdc
006 = 6.3Vdc

R

Packaging
R = Pure Tin 7" Reel
S = Pure Tin 13" Reel

0040

ESR in m Ω

TECHNICAL SPECIFICATIONS

Technical Data:	All technical data relate to an ambient temperature of +25°C is not stated				
Capacitance Range:	220 μ F to 680 μ F				
Capacitance Tolerance:	\pm 20%				
Leakage Current DCL:	0.02CV				
Rated Voltage DC (V _R)	\leq +85°C:	1.8	2.5	4	6.3
Category Voltage (V _C)	\leq +125°C:	0.9	1.3	2	3
Surge Voltage (V _S)	\leq +85°C:	2.3	3.3	5.2	8
Surge Voltage (V _S)	\leq +125°C:	1.2	1.7	2.6	4
Temperature Range:	-55°C to +125°C				
Reliability:	0.2% per 1000 hours at 85°C, V _R , 0.1 Ω /V series impedance, 60% confidence level Meets requirements of AEC-Q200				



OxiCap® NOM Low ESR Multianodes



Niobium Oxide Capacitor

CAPACITANCE AND RATED VOLTAGE RANGE (LETTER DENOTES CASE SIZE)

Capacitance		Rated Voltage DC (V _R) to 85°C / 0.66 DC to 105°C / 0.5 DC to 125°C			
μF	Code	1.8V (x)	2.5V (e)	4.0V (G)	6.3V (J)
220	227				E(40)
330	337			E(35)	E(23,35)
470	477		E(30)	E(23,30)	
680	687	E(23)	E(23)		

Available Ratings, (ESR ratings in mOhms in brackets)

Engineering samples - please contact manufacturer

*Codes under development - subject to change

Note: Voltage ratings are minimum values. AVX reserves the right to supply higher ratings in the same case size, to the same reliability standards.



LEAD-FREE

LEAD-FREE COMPATIBLE
COMPONENT



RoHS
COMPLIANT



NON-BURN
NON-SMOKE

DGP HNST
 电话: 0755-23173910

RATINGS & PART NUMBER REFERENCE

AVX Part No.	Case Size	Capacitance (μF)	Rated Voltage (V)	DCL (μA) Max.	DF % Max.	ESR Max. (mΩ) @100kHz	MSL	100kHz RMS Current (A)			100kHz RMS Voltage (V)		
								25°C	85°C	125°C	25°C	85°C	125°C
1.8 Volt @ 85°C (1.2 Volt @ 105°C / 0.9 Volt @ 125°C)													
NOME687M001#0023	E	680	1.8	24.5	6	23	3	3.753	3.378	1.501	0.086	0.078	0.035
2.5 Volt @ 85°C (1.7 Volt @ 105°C / 1.3 Volt @ 125°C)													
NOME477M002#0030	E	470	2.5	23.5	10	30	3	3.286	2.958	1.315	0.099	0.089	0.039
NOME687M002#0023	E	680	2.5	34	6	23	3	3.753	3.378	1.501	0.086	0.078	0.035
4 Volt @ 85°C (2.6 Volt @ 105°C / 2 Volt @ 125°C)													
NOME337M004#0035	E	330	4	26.4	8	35	3	3.043	2.738	1.217	0.106	0.096	0.043
NOME477M004#0023	E	470	4	37.6	6	23	3	3.753	3.378	1.501	0.086	0.078	0.035
NOME477M004#0030	E	470	4	37.6	6	30	3	3.286	2.958	1.315	0.099	0.089	0.039
6.3 Volt @ 85°C (4 Volt @ 105°C / 3 Volt @ 125°C)													
NOME227M006#0040	E	220	6.3	26.4	12	40	3	2.846	2.561	1.138	0.114	0.102	0.046
NOME337M006#0023	E	330	6.3	39.6	6	23	3	3.753	3.378	1.501	0.086	0.078	0.035
NOME337M006#0035	E	330	6.3	39.6	6	35	3	3.043	2.738	1.217	0.106	0.096	0.043

Moisture Sensitivity Level (MSL) is defined according to J-STD-020.

All technical data relates to an ambient temperature of +25°C. Capacitance and DF are measured at 120Hz, 0.5V RMS with a maximum DC bias of 2.2 volts.

DCL is measured at rated voltage after 5 minutes.

ESR allowed to move up to 125 times catalog limit post mounting.

For typical weight and composition see page 144.

NOTE: AVX reserves the right to supply a higher voltage rating or tighter tolerance part in the same case size, to the same reliability standards.

Section 3: Introduction



Foreword

AVX offers a broad line of solid Tantalum capacitors in a wide range of sizes, styles, and ratings to meet any design needs. This catalog combines into one source AVX's leaded tantalum capacitor information from its worldwide tantalum operations.

The TAP/TEP is rated for use from -55°C to $+85^{\circ}\text{C}$ at rated voltage and up to $+125^{\circ}\text{C}$ with voltage derating. There are three preferred wire forms to choose from which are available on tape and reel, and in bulk for hand insertion.

AVX has a complete tantalum applications service available for use by all our customers. With the capability to prototype and mass produce solid tantalum capacitors in special configurations, almost any design need can be fulfilled.

And if the customer requirements are outside our standard testing, AVX will work with you to define and implement a test or screening plan.

AVX is determined to become the world leader in tantalum capacitor technology and has made, and is continuing to make, significant investments in equipment and research to reach that end. We believe that the investment has paid off with the devices shown on the following pages.

Dipped Radial Capacitors

SOLID TANTALUM RESIN DIPPED SERIES TAP/TEP

The TAP/TEP resin dipped series of miniature tantalum capacitors is available for individual needs in both commercial and professional applications. From computers to automotive to industrial, AVX has a dipped radial for almost any application.

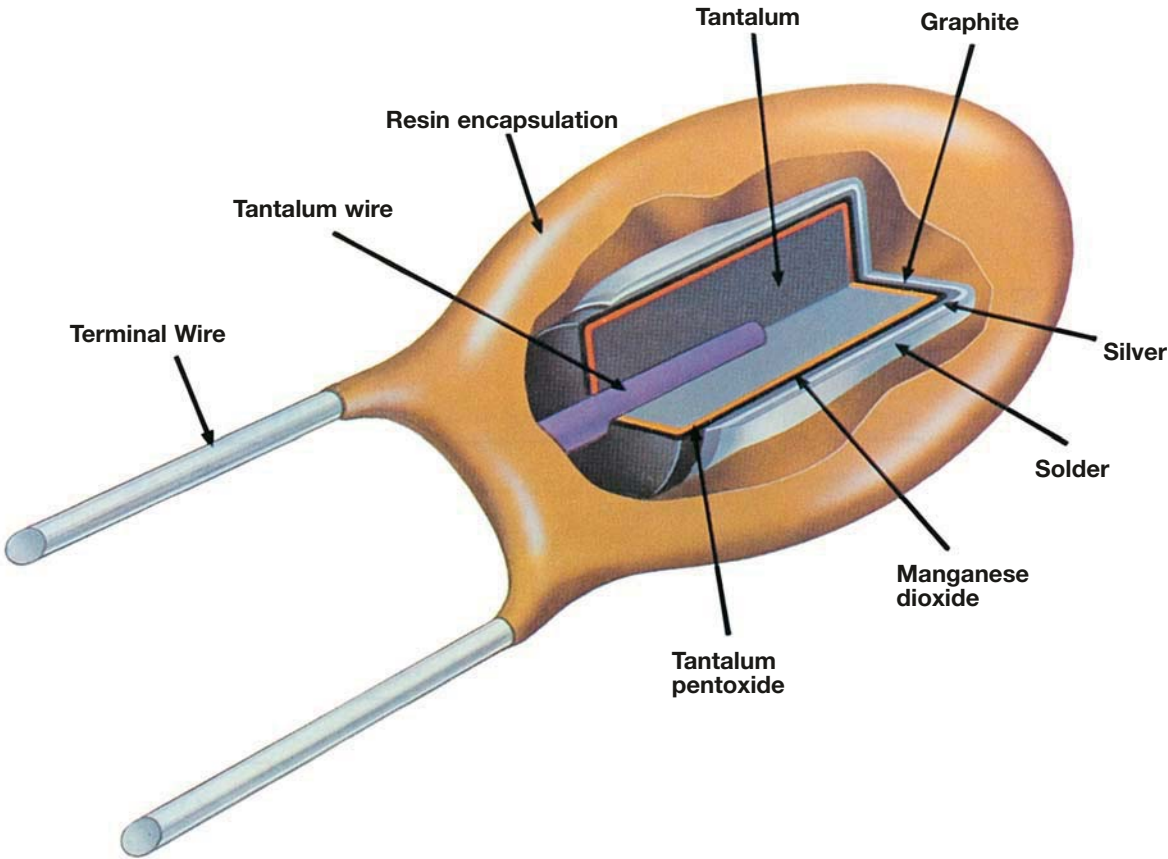

Dipped Radial Capacitors



Wire Form Outline

SOLID TANTALUM RESIN DIPPED TAP/TEP

Preferred Wire Forms

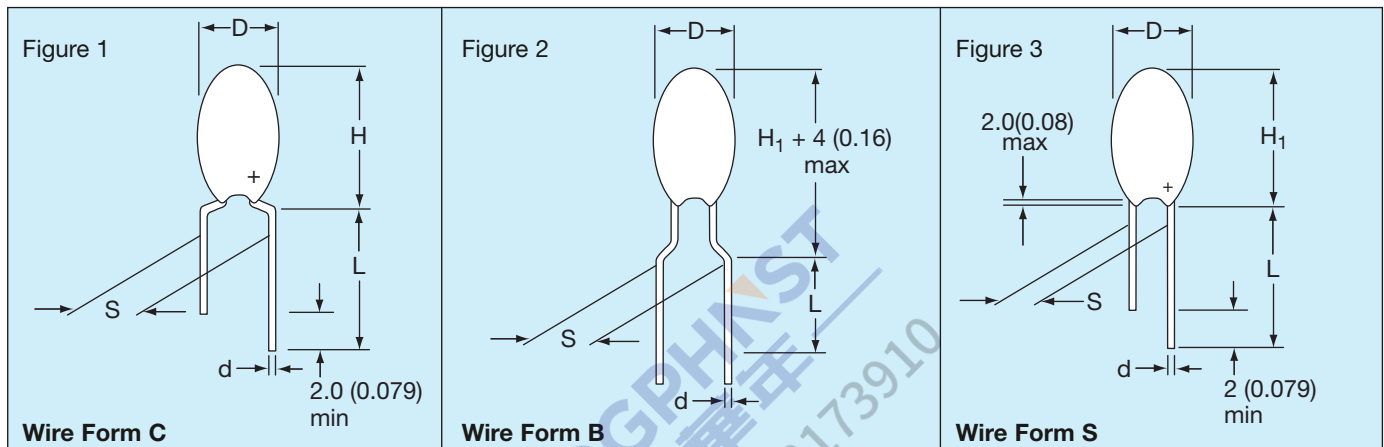

Non-Preferred Wire Forms (Not recommended for new designs)

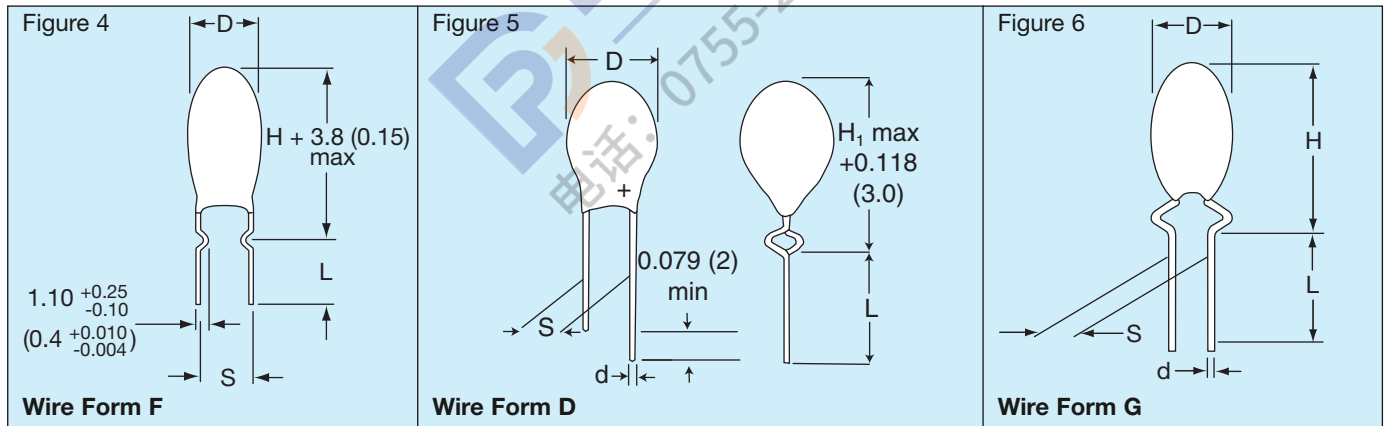

DIMENSIONS

millimeters (inches)

Wire Form	Figure	Case Size	L (see note 1)	S	d	Packaging Suffixes Available*
-----------	--------	-----------	----------------	---	---	-------------------------------

Preferred Wire Forms

C	Figure 1	A - R*	16.0±4.00 (0.630±0.160)	5.00±1.00 (0.200±0.040)	0.50±0.05 (0.020±0.002)	CCS Bulk CRW Tape/Reel CRS Tape/Ammo
B	Figure 2	A - J*	16.0±4.00 (0.630±0.160)	5.00±1.00 (0.200±0.040)	0.50±0.05 (0.020±0.002)	BRW Tape/Reel BRS Tape/Ammo
S	Figure 3	A - J*	16.0±4.00 (0.630±0.160)	2.50±0.50 (0.100±0.020)	0.50±0.05 (0.020±0.002)	SCS Bulk SRW Tape/Reel SRS Tape/Ammo

Non-Preferred Wire Forms (Not recommended for new designs)

F	Figure 4	A - R	3.90±0.75 (0.155±0.030)	5.00±0.50 (0.200±0.020)	0.50±0.05 (0.020±0.002)	FCS Bulk
D	Figure 5	A - H*	16.0±4.00 (0.630±0.160)	2.50±0.75 (0.100±0.020)	0.50±0.05 (0.020±0.002)	DCS Bulk DTW Tape/Reel DTS Tape/Ammo
G	Figure 6	A - J	16.0±4.00 (0.630±0.160)	3.18±0.50 (0.125±0.020)	0.50±0.05 (0.020±0.002)	GSB Bulk
H	Similar to Figure 1	A - R	16.0±4.00 (0.630±0.160)	6.35±1.00 (0.250±0.040)	0.50±0.05 (0.020±0.002)	HSB Bulk

Notes: (1) Lead lengths can be supplied to tolerances other than those above and should be specified in the ordering information.

(2) For D, H, and H₁ dimensions, refer to individual product on following pages.

* For case size availability in tape and reel, please refer to pages 123-124.



Dipped Radial Capacitors



TAP Series

SOLID TANTALUM RESIN DIPPED CAPACITORS

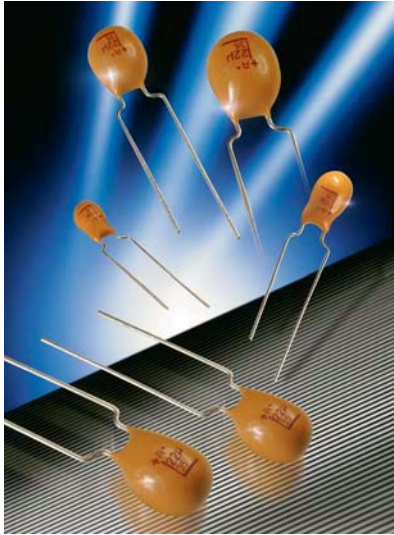

TAP is a professional grade device manufactured with a flame retardant coating and featuring low leakage current and impedance, very small physical sizes and exceptional temperature stability. It is designed and conditioned to operate to +125°C (see page 153 for voltage derating above 85°C) and is available loose or taped and reeled for auto insertion. The 15 case sizes with wide capacitance and working voltage ranges means the TAP can accommodate almost any application.



MAXIMUM CASE DIMENSIONS: millimeters (inches)

Wire Case	C, F, G, H H	B, S, D *H ₁	D
A	8.50 (0.330)	7.00 (0.280)	4.50 (0.180)
B	9.00 (0.350)	7.50 (0.300)	4.50 (0.180)
C	10.0 (0.390)	8.50 (0.330)	5.00 (0.200)
D	10.5 (0.410)	9.00 (0.350)	5.00 (0.200)
E	10.5 (0.410)	9.00 (0.350)	5.50 (0.220)
F	11.5 (0.450)	10.0 (0.390)	6.00 (0.240)
G	11.5 (0.450)	10.0 (0.390)	6.50 (0.260)
H	12.0 (0.470)	10.5 (0.410)	7.00 (0.280)
J	13.0 (0.510)	11.5 (0.450)	8.00 (0.310)
K	14.0 (0.550)	12.5 (0.490)	8.50 (0.330)
L	14.0 (0.550)	12.5 (0.490)	9.00 (0.350)
M	14.5 (0.570)	13.0 (0.510)	9.00 (0.350)
N	16.0 (0.630)		9.00 (0.350)
P	17.0 (0.670)		10.0 (0.390)
R	18.5 (0.730)		10.0 (0.390)

HOW TO ORDER

TAP

Type

475

Capacitance Code
pF code: 1st two digits
represent significant figures,
3rd digit represents multiplier
(number of zeros to follow)

M

Capacitance Tolerance
K = ±10%
M = ±20%
(For J = ±5% tolerance,
please consult factory)

035

Rated DC Voltage

SCS

Suffix indicating wire form
and packaging
(see page 116)



Dipped Radial Capacitors



TAP Series

TECHNICAL SPECIFICATIONS

Technical Data:	All technical data relate to an ambient temperature of +25°C							
Capacitance Range:	0.10 μ F to 330 μ F							
Capacitance Tolerance:	\pm 20%; \pm 10% (\pm 5% consult your AVX representative for details)							
Rated Voltage DC (V_R)	$\leq +85^\circ\text{C}$:	6.3	10	16	20	25	35	50
Category Voltage (V_C)	$\leq +125^\circ\text{C}$:	4	6.3	10	13	16	23	33
Surge Voltage (V_S)	$\leq +85^\circ\text{C}$:	8	13	20	26	33	46	65
Surge Voltage (V_S)	$\leq +125^\circ\text{C}$:	5	9	12	16	21	28	40
Temperature Range:	-55°C to +125°C							
Environmental Classification:	55/125/56 (IEC 68-2)							
Dissipation Factor:	\leq 0.04 for C_R 0.1-1.5 μ F							
	\leq 0.06 for C_R 2.2-6.8 μ F							
	\leq 0.08 for C_R 10-68 μ F							
	\leq 0.10 for C_R 100-330 μ F							
Reliability:	1% per 1000 hrs. at 85°C with 0.1 Ω /V series impedance, 60% confidence level.							
Qualification:	CECC 30201 - 032							

Capacitance Range (letter denotes case size)								
Capacitance		Rated voltage DC (V_R)						
μ F	Code	6.3V	10V	16V	20V	25V	35V	50V
0.10	104						A	A
0.15	154						A	A
0.22	224						A	A
0.33	334						A	A
0.47	474						A	A
0.68	684						A	B
1.0	105				A	A	A	C
1.5	155			A	A	A	A	D
2.2	225		A	A	A	A	B	E
3.3	335	A	A	A	B	B	C	F
4.7	475	A	A	B	C	C	E	G
6.8	685	A	B	C	D	D	F	H
10	106	B	C	D	E	E	F	J
15	156	C	D	E	F	F	H	K
22	226	D	E	F	H	H	K	L
33	336	E	F	F	J	J	M	
47	476	F	G	J	K	M	N	
68	686	G	H	L	N	N		
100	107	H	K	N	N			
150	157	K	N	N				
220	227	M	P	R				
330	337	P	R					

Values outside this standard range may be available on request.
 AVX reserves the right to supply capacitors to a higher voltage rating, in the same case size, than that ordered.

MARKING

Polarity, capacitance, rated DC voltage, and an "A" (AVX logo) are laser marked on the capacitor body which is made of flame retardant gold epoxy resin with a limiting oxygen index in excess of 30 (ASTM-D-2863).

- Polarity
- Tolerance code:
- Capacitance \pm 20% = Standard (no marking)
- Voltage \pm 10% = "K" on reverse side of unit
- AVX logo \pm 5% = "J" on reverse side of unit

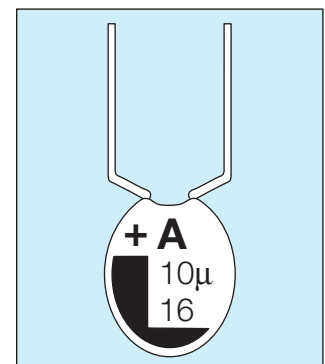

Dipped Radial Capacitors



TAP Series

RATINGS AND PART NUMBER REFERENCE

AVX Part No.	Case Size	Capacitance μ F	DCL (μ A) Max.	DF % Max.	ESR Max. (Ω) @ 100 kHz
6.3 volt @ 85°C (4 volt @ 125°C)					
TAP 335(+006	A	3.3	0.5	6	13.0
TAP 475(+006	A	4.7	0.5	6	10.0
TAP 685(+006	A	6.8	0.5	6	8.0
TAP 106(+006	B	10	0.5	8	6.0
TAP 156(+006	C	15	0.8	8	5.0
TAP 226(+006	D	22	1.1	8	3.7
TAP 336(+006	E	33	1.7	8	3.0
TAP 476(+006	F	47	2.4	8	2.0
TAP 686(+006	G	68	3.4	8	1.8
TAP 107(+006	H	100	5.0	10	1.6
TAP 157(+006	K	150	7.6	10	0.9
TAP 227(+006	M	220	11.0	10	0.9
TAP 337(+006	P	330	16.6	10	0.7
10 volt @ 85°C (6.3 volt @ 125°C)					
TAP 225(+010	A	2.2	0.5	6	13.0
TAP 335(+010	A	3.3	0.5	6	10.0
TAP 475(+010	A	4.7	0.5	6	8.0
TAP 685(+010	B	6.8	0.5	6	6.0
TAP 106(+010	C	10	0.8	8	5.0
TAP 156(+010	D	15	1.2	8	3.7
TAP 226(+010	E	22	1.7	8	2.7
TAP 336(+010	F	33	2.6	8	2.1
TAP 476(+010	G	47	3.7	8	1.7
TAP 686(+010	H	68	5.4	8	1.3
TAP 107(+010	K	100	8.0	10	1.0
TAP 157(+010	N	150	12.0	10	0.8
TAP 227(+010	P	220	17.6	10	0.6
TAP 337(+010	R	330	20.0	10	0.5
16 volt @ 85°C (10 volt @ 125°C)					
TAP 155(+016	A	1.5	0.5	4	10.0
TAP 225(+016	A	2.2	0.5	6	8.0
TAP 335(+016	A	3.3	0.5	6	6.0
TAP 475(+016	B	4.7	0.6	6	5.0
TAP 685(+016	C	6.8	0.8	6	4.0
TAP 106(+016	D	10	1.2	8	3.2
TAP 156(+016	E	15	1.9	8	2.5
TAP 226(+016	F	22	2.8	8	2.0
TAP 336(+016	F	33	4.2	8	1.6
TAP 476(+016	J	47	6.0	8	1.3
TAP 686(+016	L	68	8.7	8	1.0
TAP 107(+016	N	100	12.8	10	0.8
TAP 157(+016	N	150	19.2	10	0.6
TAP 227(+016	R	220	20.0	10	0.5
20 volt @ 85°C (13 volt @ 125°C)					
TAP 105(+020	A	1.0	0.5	4	10.0
TAP 155(+020	A	1.5	0.5	4	9.0
TAP 225(+020	A	2.2	0.5	6	7.0
TAP 335(+020	B	3.3	0.5	6	5.5
TAP 475(+020	C	4.7	0.7	6	4.5
TAP 685(+020	D	6.8	1.0	6	3.6
TAP 106(+020	E	10	1.6	8	2.9
TAP 156(+020	F	15	2.4	8	2.3
TAP 226(+020	H	22	3.5	8	1.8
TAP 336(+020	J	33	5.2	8	1.4
TAP 476(+020	K	47	7.5	8	1.2
TAP 686(+020	N	68	10.8	8	0.9
TAP 107(+020	N	100	16.0	10	0.6

AVX Part No.	Case Size	Capacitance μ F	DCL (μ A) Max.	DF % Max.	ESR Max. (Ω) @ 100 kHz
25 volt @ 85°C (16 volt @ 125°C)					
TAP 105(+025	A	1.0	0.5	4	10.0
TAP 155(+025	A	1.5	0.5	4	8.0
TAP 225(+025	A	2.2	0.5	6	6.0
TAP 335(+025	B	3.3	0.6	6	5.0
TAP 475(+025	C	4.7	0.9	6	4.0
TAP 685(+025	D	6.8	1.3	6	3.1
TAP 106(+025	E	10	2.0	8	2.5
TAP 156(+025	F	15	3.0	8	2.0
TAP 226(+025	H	22	4.4	8	1.5
TAP 336(+025	J	33	6.6	8	1.2
TAP 476(+025	M	47	9.4	8	1.0
TAP 686(+025	N	68	13.6	8	0.8
35 volt @ 85°C (23 volt @ 125°C)					
TAP 104(+035	A	0.1	0.5	4	26.0
TAP 154(+035	A	0.15	0.5	4	21.0
TAP 224(+035	A	0.22	0.5	4	17.0
TAP 334(+035	A	0.33	0.5	4	15.0
TAP 474(+035	A	0.47	0.5	4	13.0
TAP 684(+035	A	0.68	0.5	4	10.0
TAP 105(+035	A	1.0	0.5	4	8.0
TAP 155(+035	A	1.5	0.5	4	6.0
TAP 225(+035	B	2.2	0.6	6	5.0
TAP 335(+035	C	3.3	0.9	6	4.0
TAP 475(+035	E	4.7	1.3	6	3.0
TAP 685(+035	F	6.8	1.9	6	2.5
TAP 106(+035	F	10	2.8	8	2.0
TAP 156(+035	H	15	4.2	8	1.6
TAP 226(+035	K	22	6.1	8	1.3
TAP 336(+035	M	33	9.2	8	1.0
TAP 476(+035	N	47	10.0	8	0.8
50 volt @ 85°C (33 volt @ 125°C)					
TAP 104(+050	A	0.1	0.5	4	26.0
TAP 154(+050	A	0.15	0.5	4	21.0
TAP 224(+050	A	0.22	0.5	4	17.0
TAP 334(+050	A	0.33	0.5	4	15.0
TAP 474(+050	A	0.47	0.5	4	13.0
TAP 684(+050	B	0.68	0.5	4	10.0
TAP 105(+050	C	1.0	0.5	4	8.0
TAP 155(+050	D	1.5	0.6	4	6.0
TAP 225(+050	E	2.2	0.8	6	3.5
TAP 335(+050	F	3.3	1.3	6	3.0
TAP 475(+050	G	4.7	1.8	6	2.5
TAP 685(+050	H	6.8	2.7	6	2.0
TAP 106(+050	J	10	4.0	8	1.6
TAP 156(+050	K	15	6.0	8	1.2
TAP 226(+050	L	22	8.8	8	1.0

(*) Insert capacitance tolerance code; M for $\pm 20\%$, K for $\pm 10\%$ and J for $\pm 5\%$

NOTE: Voltage ratings are minimum values. AVX reserves the right to supply higher voltage ratings in the same case size.

Dipped Radial Capacitors



TEP Series Tin-Lead (Sn/Pb) Finish Product



TEP is a Tin-Lead finish version of the conformally coated tantalum radial leaded capacitor (TAP). It is a professional grade device manufactured with a flame retardant coating and featuring low leakage current and impedance, very small physical sizes and exceptional temperature stability, available in bulk and T&R packaging for auto insertion. The wide range of Capacitance, working voltages and case sizes enables TEP to accommodate to almost any application.

Not RoHS Compliant

CASE DIMENSIONS: millimeters (inches)

Wire Case	C, F, G, H H	B, S, D *H ₁	D
A	8.50 (0.335)	7.00 (0.276)	4.50 (0.177)
B	9.00 (0.354)	7.50 (0.295)	4.50 (0.177)
C	10.0 (0.394)	8.50 (0.335)	5.00 (0.197)
D	10.5 (0.413)	9.00 (0.354)	5.00 (0.197)
E	10.5 (0.413)	9.00 (0.354)	5.50 (0.217)
F	11.5 (0.453)	10.0 (0.394)	6.00 (0.236)
G	11.5 (0.453)	10.0 (0.394)	6.50 (0.256)
H	12.0 (0.472)	10.5 (0.413)	7.00 (0.276)
J	13.0 (0.512)	11.5 (0.453)	8.00 (0.315)
K	14.0 (0.551)		8.50 (0.335)
L	14.0 (0.551)		9.00 (0.354)
M	14.5 (0.571)		9.00 (0.354)
N	16.0 (0.630)		9.00 (0.354)
P	17.0 (0.669)		10.0 (0.394)
R	18.5 (0.728)		10.0 (0.394)

HOW TO ORDER

TEP

Type

106

Capacitance Code
pF code: 1st two digits represent significant figures, 3rd digit represents multiplier (number of zeros to follow)

M

Capacitance Tolerance
K = ±10%
M = ±20%
(For J = ±5% tolerance, please consult factory)

016

Rated DC Voltage

SCS

Suffix indicating wire form and packaging
(see page 116)

Dipped Radial Capacitors



TEP Series

TECHNICAL SPECIFICATIONS

Technical Data:	All technical data relate to an ambient temperature of +25°C							
Capacitance Range:	0.10 μ F to 330 μ F							
Capacitance Tolerance:	\pm 10%; \pm 20% (\pm 5% consult your AVX representative for details)							
Rated Voltage DC (V_R)	\leq +85°C:	6.3	10	16	20	25	35	50
Category Voltage (V_C)	\leq +125°C:	4	6.3	10	13	16	23	33
Surge Voltage (V_S)	\leq +85°C:	8	13	20	26	33	46	65
Surge Voltage (V_S)	\leq +125°C:	5	9	12	16	21	28	40
Temperature Range:	-55°C to +125°C							
Dissipation Factor:	\leq 0.04 for C_R 0.1-1.5 μ F							
	\leq 0.06 for C_R 2.2-6.8 μ F							
	\leq 0.08 for C_R 10-68 μ F							
	\leq 0.10 for C_R 100-330 μ F							
Reliability:	1% per 1000 hrs. at 85°C, V_R with 0.1 Ω /V series impedance, 60% confidence level.							

Capacitance Range (letter denotes case size)		Rated voltage DC (V_R)							
μ F	Code	6.3V	10V	16V	20V	25V	35V	50V	
0.10	104						A	A	
0.15	154						A	A	
0.22	224						A	A	
0.33	334						A	A	
0.47	474						A	A	
0.68	684						A	B	
1.0	105				A	A	A	C	
1.5	155			A	A	A	A	D	
2.2	225		A	A	A	A	B	E	
3.3	335	A	A	A	B	B	C	F	
4.7	475	A	A	B	C	C	E	G	
6.8	685	A	B	C	D	D	F	H	
10	106	B	C	D	E	E	F	J	
15	156	C	D	E	F	F	H	K	
22	226	D	E	F	H	H	K	L	
33	336	E	F	F	J	J	M		
47	476	F	G	J	K	M	N		
68	686	G	H	L	N	N			
100	107	H	K	N	N				
150	157	K	N	N					
220	227	M	P	R					
330	337	P	R						

Values outside this standard range may be available on request.
 AVX reserves the right to supply capacitors to a higher voltage rating, in the same case size, than that ordered.

MARKING

Polarity, capacitance, rated DC voltage, and an "A" (AVX logo) are laser marked on the capacitor body which is made of flame retardant gold epoxy resin with a limiting oxygen index in excess of 30 (ASTM-D-2863).

- Polarity
- Capacitance
- Voltage
- AVX logo
- Tolerance code:
 - \pm 20% = Standard (no marking)
 - \pm 10% = "K" on reverse side of unit
 - \pm 5% = "J" on reverse side of unit

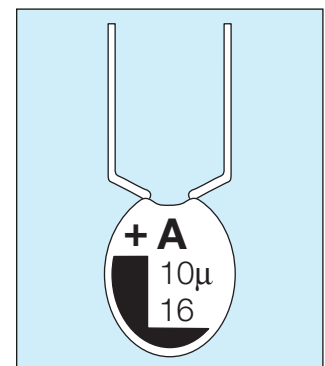

Dipped Radial Capacitors



TEP Series

RATINGS & PART NUMBER REFERENCE

AVX Part No.	Case Size	Cap (µF)	DCL (µA) Max.	DF % Max.	ESR Max. (Ω) @100kHz
TEP335(*)006	A	3.3	0.5	6	13
TEP475(*)006	A	4.7	0.5	6	10
TEP685(*)006	A	6.8	0.5	6	8
TEP106(*)006	B	10	0.5	8	6
TEP156(*)006	C	15	0.8	8	5
TEP226(*)006	D	22	1.1	8	3.7
TEP336(*)006	E	33	1.7	8	3
TEP476(*)006	F	47	2.4	8	2
TEP686(*)006	G	68	3.4	8	1.8
TEP107(*)006	H	100	5	10	1.6
TEP157(*)006	K	150	7.6	10	0.9
TEP227(*)006	M	220	11	10	0.9
TEP337(*)006	P	330	16.6	10	0.7
TEP335(*)006	A	3.3	0.5	6	13
TEP225(*)010	A	2.2	0.5	6	13
TEP335(*)010	A	3.3	0.5	6	10
TEP475(*)010	A	4.7	0.5	6	8
TEP685(*)010	B	6.8	0.5	6	6
TEP106(*)010	C	10	0.8	8	5
TEP156(*)010	D	15	1.2	8	3.7
TEP226(*)010	E	22	1.7	8	2.7
TEP336(*)010	F	33	2.6	8	2.1
TEP476(*)010	G	47	3.7	8	1.7
TEP686(*)010	H	68	5.4	8	1.3
TEP107(*)010	K	100	8	10	1
TEP157(*)010	N	150	12	10	0.8
TEP227(*)010	P	220	17.6	10	0.6
TEP337(*)010	R	330	20	10	0.5
TEP155(*)016	A	1.5	0.5	4	10
TEP225(*)016	A	2.2	0.5	6	8
TEP335(*)016	A	3.3	0.5	6	6
TEP475(*)016	B	4.7	0.6	6	5
TEP685(*)016	C	6.8	0.8	6	4
TEP106(*)016	D	10	1.2	8	3.2
TEP156(*)016	E	15	1.9	8	2.5
TEP226(*)016	F	22	2.8	8	2
TEP336(*)016	F	33	4.2	8	1.6
TEP476(*)016	J	47	6	8	1.3
TEP686(*)016	L	68	8.7	8	1
TEP107(*)016	N	100	12.8	10	0.8
TEP157(*)016	N	150	19.2	10	0.6
TEP227(*)016	R	220	20	10	0.5
TEP105(*)020	A	1	0.5	4	10
TEP155(*)020	A	1.5	0.5	4	9
TEP225(*)020	A	2.2	0.5	6	7
TEP335(*)020	B	3.3	0.5	6	5.5
TEP475(*)020	C	4.7	0.7	6	4.5
TEP685(*)020	D	6.8	1	6	3.6
TEP106(*)020	E	10	1.6	8	2.9
TEP156(*)020	F	15	2.4	8	2.3

AVX Part No.	Case Size	Cap (µF)	DCL (µA) Max.	DF % Max.	ESR Max. (Ω) @100kHz
TEP226(*)020	H	22	3.5	8	1.8
TEP336(*)020	J	33	5.2	8	1.4
TEP476(*)020	K	47	7.5	8	1.2
TEP686(*)020	N	68	10.8	8	0.9
TEP107(*)020	N	100	16	10	0.6
TEP105(*)025	A	1	0.5	4	10
TEP155(*)025	A	1.5	0.5	4	8
TEP225(*)025	A	2.2	0.5	6	6
TEP335(*)025	B	3.3	0.6	6	5
TEP475(*)025	C	4.7	0.9	6	4
TEP685(*)025	D	6.8	1.3	6	3.1
TEP106(*)025	E	10	2	8	2.5
TEP156(*)025	F	15	3	8	2
TEP226(*)025	H	22	4.4	8	1.5
TEP336(*)025	J	33	6.6	8	1.2
TEP476(*)025	M	47	9.4	8	1
TEP686(*)025	N	68	13.6	8	0.8
TEP104(*)035	A	0.1	0.5	4	26
TEP154(*)035	A	0.15	0.5	4	21
TEP224(*)035	A	0.22	0.5	4	17
TEP334(*)035	A	0.33	0.5	4	15
TEP474(*)035	A	0.47	0.5	4	13
TEP684(*)035	A	0.68	0.5	4	10
TEP105(*)035	A	1	0.5	4	8
TEP155(*)035	A	1.5	0.5	4	6
TEP225(*)035	B	2.2	0.6	6	5
TEP335(*)035	C	3.3	0.9	6	4
TEP475(*)035	E	4.7	1.3	6	3
TEP685(*)035	F	6.8	1.9	6	2.5
TEP106(*)035	F	10	2.8	8	2
TEP156(*)035	H	15	4.2	8	1.6
TEP226(*)035	K	22	6.1	8	1.3
TEP336(*)035	M	33	9.2	8	1
TEP476(*)035	N	47	10	8	0.8
TEP104(*)050	A	0.1	0.5	4	26
TEP154(*)050	A	0.15	0.5	4	21
TEP224(*)050	A	0.22	0.5	4	17
TEP334(*)050	A	0.33	0.5	4	15
TEP474(*)050	A	0.47	0.5	4	13
TEP684(*)050	B	0.68	0.5	4	10
TEP105(*)050	C	1	0.5	4	8
TEP155(*)050	D	1.5	0.6	4	6
TEP225(*)050	E	2.2	0.8	6	3.5
TEP335(*)050	F	3.3	1.3	6	3
TEP475(*)050	G	4.7	1.8	6	2.5
TEP685(*)050	H	6.8	2.7	6	2
TEP106(*)050	J	10	4	8	1.6
TEP156(*)050	K	15	6	8	1.2
TEP226(*)050	L	22	8.8	8	1

Tape and Reel Packaging

SOLID TANTALUM RESIN DIPPED TAP/TEP

TAPE AND REEL PACKAGING FOR AUTOMATIC COMPONENT INSERTION

TAP/TEP types are all offered on radial tape, in reel or 'ammo' pack format for use on high speed radial automatic insertion equipment, or preforming machines.

The tape format is compatible with EIA 468A standard for component taping set out by major manufacturers of radial automatic insertion equipment.

TAP/TEP – available in three formats. See page 124 for dimensions.

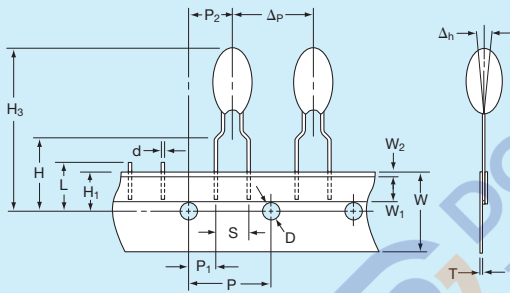

'B' wires for normal automatic insertion on 5mm pitch.

BRW suffix for reel
BRS suffix for 'ammo' pack
Available in case sizes A - J

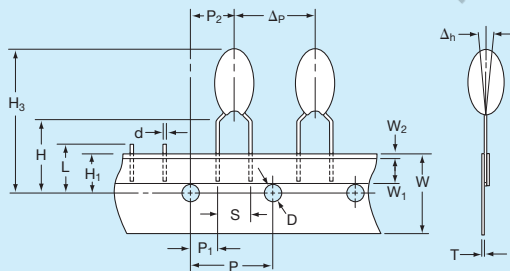

'C' wires for preforming.

CRW suffix for reel
CRS suffix for 'ammo' pack
Available in case sizes A - R

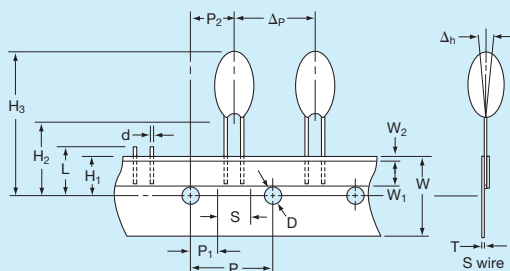

'S' and 'D' wire for special applications, automatic insertion on 2.5mm pitch.

SRW, DTW suffix for reel
SRS, DTS suffix for 'ammo' pack
Available in case sizes A - J

Dipped Radial Capacitors



Tape and Reel Packaging

SOLID TANTALUM RESIN DIPPED TAP/TEP

CASE DIMENSIONS: millimeters (inches)

Description	Code	Dimension
Feed hole pitch	P	12.7 ± 0.30 (0.500 ± 0.010)
Hole center to lead	P ₁	3.85 ± 0.70 (0.150 ± 0.030) to be measured at bottom of clench
		5.05 ± 1.00 (0.200 ± 0.040) for S wire
Hole center to component center	P ₂	6.35 ± 0.40 (0.250 ± 0.020)
Change in pitch	Δp	± 1.00 (± 0.040)
Lead diameter	d	0.50 ± 0.05 (0.020 ± 0.003)
Lead spacing	S	See wire form table
Component alignment	Δh	0 ± 2.00 (0 ± 0.080)
Feed hole diameter	D	4.00 ± 0.20 (0.150 ± 0.008)
Tape width	W	18.0 + 1.00 (0.700 + 0.040) - 0.50 - 0.020
Hold down tape width	W ₁	6.00 (0.240) min.
Hold down tape position	W ₂	1.00 (0.040) max.
Lead wire clench height	H	16.0 ± 0.50 (0.630 ± 0.020)
		19.0 ± 1.00 (0.750 ± 0.040) on request
Hole position	H ₁	9.00 ± 0.50 (0.350 ± 0.020)
Base of component height	H ₂	18.0 (0.700) min. (S wire only)
Component height	H ₃	32.25 (1.300) max.
Length of snipped lead	L	11.0 (0.430) max.
Total tape thickness	T	0.70 ± 0.20 (0.030 ± 0.001)
		Carrying card 0.50 ± 0.10 (0.020 ± 0.005)

REEL CONFIGURATION AND DIMENSIONS: millimeters (inches)

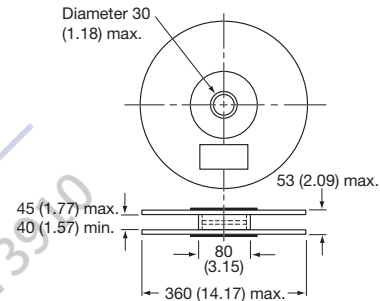

Manufactured from cardboard with plastic hub.

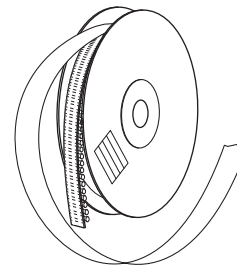

Holding tape outside. Positive terminal leading.

PACKAGING QUANTITIES

For Reels

Style	Case size	No. of pieces
TAP TEP	A	1500
	B, C, D	1250
	E, F	1000
	G, H, J	750
	K, L, M, N, P, R	500

For 'Ammo' pack

Style	Case size	No. of pieces
TAP TEP	A, B, C, D	3000
	E, F, G	2500
	H, J	2000
	K, L, M, N, P, R	1000

For bulk products

Style	Case size	No. of pieces
TAP TEP	A to H	1000
	J to L	500
	M to R	100

AMMO PACK DIMENSIONS

millimeters (inches) max.

Height 360 (14.17), width 360 (14.17), thickness 60 (2.36)

GENERAL NOTES

Resin dipped tantalum capacitors are only available taped in the range of case sizes and in the modular quantities by case size as indicated.

Packaging quantities on tape may vary by ±1%.

Section 4: Technical Summary and Application Guidelines



INTRODUCTION

Tantalum capacitors are manufactured from a powder of pure tantalum metal. OxiCap® - niobium oxide capacitor is made from niobium oxide NbO powder. The typical particle size is between 2 and 10 μm.

Figure below shows typical powders. Note the very great difference in particle size between the powder CVs/g.

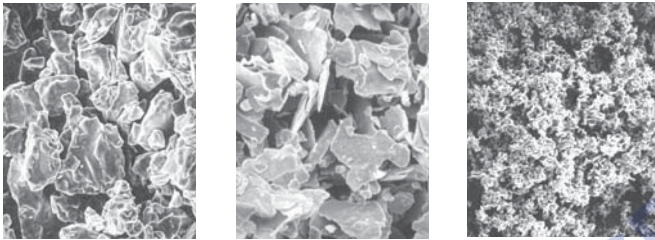

4000μFV

20000μFV

50000μFV

Figure 1a. Tantalum powder

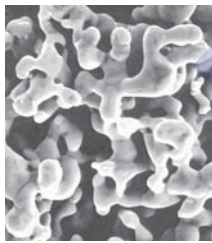

Figure 1b. Niobium Oxide powder

The powder is compressed under high pressure around a Tantalum or Niobium wire (known as the Riser Wire) to form a “pellet”. The riser wire is the anode connection to the capacitor.

This is subsequently vacuum sintered at high temperature (typically 1200 - 1800°C) which produces a mechanically strong pellet and drives off any impurities within the powder.

During sintering the powder becomes a sponge like structure with all the particles interconnected in a huge lattice.

This structure is of high mechanical strength and density, but is also highly porous giving a large internal surface area (see Figure 2).

The larger the surface area the larger the capacitance. Thus high CV/g (capacitance voltage product per gram) powders, which have a low average particle size, are used for low voltage, high capacitance parts.

By choosing which powder and sinter temperature is used to produce each capacitance/voltage rating the surface area can be controlled.

The following example uses a 220μF 6V capacitor to illustrate the point.

$$C = \frac{\epsilon_0 \epsilon_r A}{d}$$

where ϵ_0 is the dielectric constant of free space (8.855 x 10⁻¹² Farads/m)

ϵ_r is the relative dielectric constant

= 27 for Tantalum Pentoxide

= 41 for Niobium Pentoxide

d is the dielectric thickness in meters

C is the capacitance in Farads

and A is the surface area in meters

Rearranging this equation gives:

$$A = \frac{Cd}{\epsilon_0 \epsilon_r}$$

thus for a 220μF/6V capacitor the surface area is 346 square centimeters, or nearly a half times the size of this page.

The dielectric is then formed over all the Tantalum or niobium oxide surfaces by the electrochemical process of anodization. To activate this, the “pellet” is dipped into a very weak solution of phosphoric acid.

The dielectric thickness is controlled by the voltage applied during the forming process. Initially the power supply is kept in a constant current mode until the correct thickness of dielectric has been reached (that is the voltage reaches the “forming voltage”), it then switches to constant voltage mode and the current decays to close to zero.

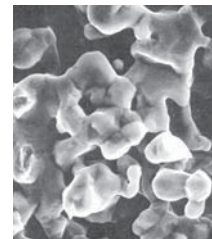
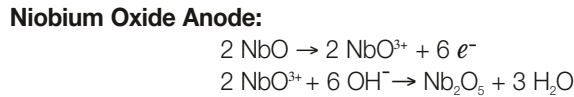
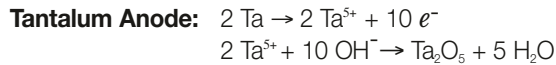

Figure 2. Sintered Anode

Technical Summary and Application Guidelines



The chemical equations describing the process are as follows:



Cathode:

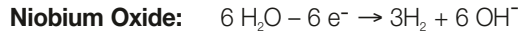
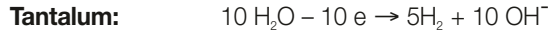

The oxide forms on the surface of the Tantalum or Niobium Oxide but it also grows into the material. For each unit of oxide two thirds grows out and one third grows in. It is for this reason that there is a limit on the maximum voltage rating of Tantalum & Niobium Oxide capacitors with present technology powders (see Figure 3).

The dielectric operates under high electrical stress. Consider a 220µF 6V part:

Formation voltage = Formation Ratio x Working Voltage
 = 3.5 x 6
 = 21 Volts

Tantalum:

The pentoxide (Ta_2O_5) dielectric grows at a rate of 1.7×10^{-9} m/V

Dielectric thickness (d) = $21 \times 1.7 \times 10^{-9}$
 = 0.036 µm

Electric Field strength = Working Voltage / d
 = 167 KV/mm

Niobium Oxide:

The niobium oxide (Nb_2O_5) dielectric grows at a rate of 2.4×10^{-9} m/V

Dielectric thickness (d) = $21 \times 2.4 \times 10^{-9}$
 = 0.050 µm

Electric Field strength = Working Voltage / d
 = 120 KV/mm

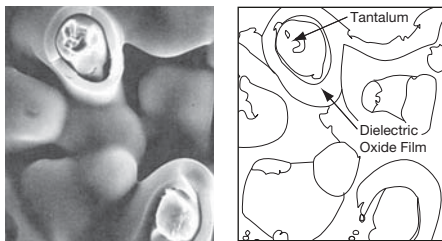
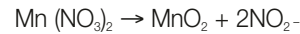

Figure 3. Dielectric layer

The next stage is the production of the cathode plate. This is achieved by pyrolysis of Manganese Nitrate into Manganese Dioxide.

The “pellet” is dipped into an aqueous solution of nitrate and then baked in an oven at approximately 250°C to produce the dioxide coat. The chemical equation is:



This process is repeated several times through varying specific densities of nitrate to build up a thick coat over all internal and external surfaces of the “pellet”, as shown in Figure 4.

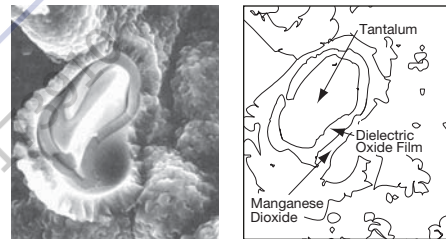

Figure 4. Manganese Dioxide Layer

The “pellet” is then dipped into graphite and silver to provide a good connection to the Manganese Dioxide cathode plate. Electrical contact is established by deposition of carbon onto the surface of the cathode. The carbon is then coated with a conductive material to facilitate connection to the cathode termination (see Figure 5). Packaging is carried out to meet individual specifications and customer requirements. This manufacturing technique is adhered to for the whole range of AVX Tantalum capacitors, which can be subdivided into four basic groups: Chip / Resin dipped / Rectangular boxed / Axial.

Further information on production of Tantalum Capacitors can be obtained from the technical paper “Basic Tantalum Technology”, by John Gill, available from your local AVX representative.

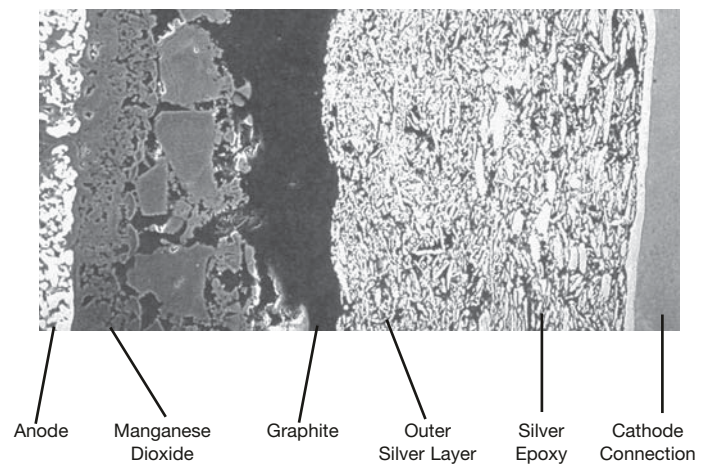

Figure 5. Cathode Termination



Technical Summary and Application Guidelines



SECTION 1 ELECTRICAL CHARACTERISTICS AND EXPLANATION OF TERMS

1.1 CAPACITANCE

1.1.1 Rated capacitance (C_R).

This is the nominal rated capacitance. For tantalum and OxiCap® capacitors it is measured as the capacitance of the equivalent series circuit at 25°C using a measuring bridge supplied by a 0.5V rms 120Hz sinusoidal signal, free of harmonics with a bias of 2.2Vd.c.

1.1.2 Capacitance tolerance.

This is the permissible variation of the actual value of the capacitance from the rated value. For additional reading, please consult the AVX technical publication "Capacitance Tolerances for Solid Tantalum Capacitors".

1.1.3 Temperature dependence of capacitance.

The capacitance of a tantalum capacitor varies with temperature. This variation itself is dependent to a small extent on the rated voltage and capacitor size.

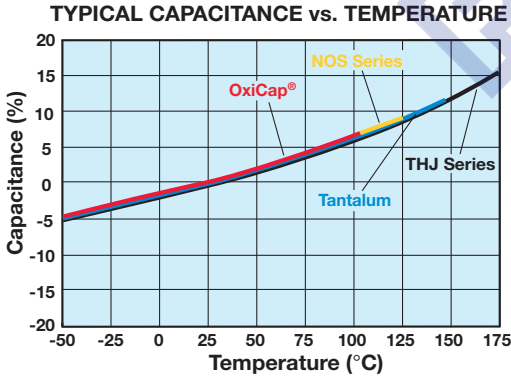

1.1.4 Frequency dependence of the capacitance.

The effective capacitance decreases as frequency increases. Beyond 100kHz the capacitance continues to drop until resonance is reached (typically between 0.5 - 5MHz depending on the rating). Beyond the resonant frequency the device becomes inductive.

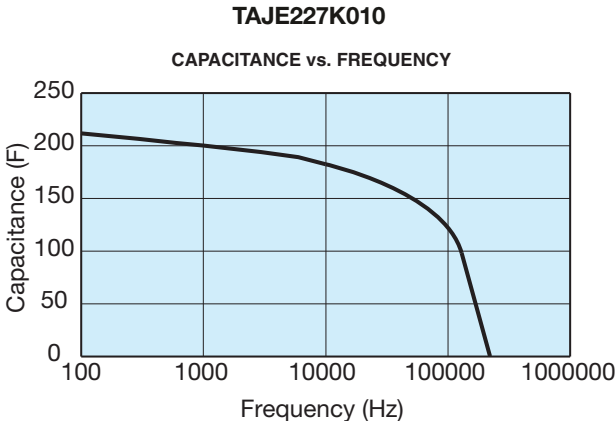

For individual part number please refer to SpiTan Software for frequency and temperature behavior found on AVX Corporation website.

1.2 VOLTAGE

1.2.1 Rated d.c. voltage (V_R).

This is the rated d.c. voltage for continuous operation up to 85°C (up to 40°C for TLJ, TLN, NLJ series).

Operating voltage consists of the sum of DC bias voltage and ripple peak voltage. The peak voltage should not exceed the category voltage. For recommended voltage (application) derating refer to figure 2c of the SECTION 3.

1.2.2 Category voltage (V_C).

This is the maximum voltage that may be applied continuously to a capacitor. It is equal to the rated voltage up to +85°C (up to 40°C for TLJ, TLN, NLJ series), beyond which it is subject to a linear derating, to 2/3 V_R at 125°C for tantalum and 2/3 V_R at 105°C for OxiCap®.

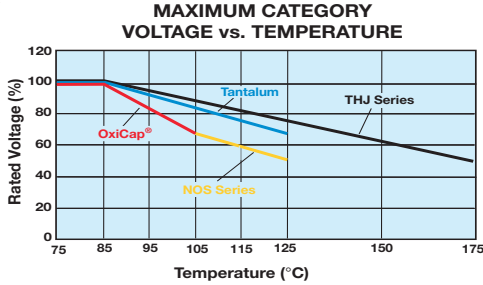

1.2.3 Surge voltage (V_S).

This is the highest voltage that may be applied to a capacitor for short periods of time in circuits with minimum series resistance of 330ohms (CECC states 1kΩ). The surge voltage may be applied up to 10 times in an hour for periods of up to 30 seconds at a time. The surge voltage must not be used as a parameter in the design of circuits in which, in the normal course of operation, the capacitor is periodically charged and discharged.

85°C Tantalum		125°C Tantalum*	
Rated Voltage V_R	Surge Voltage V_S	Category Voltage V_C	Surge Voltage V_S
2	2.7	1.3	1.7
2.5	3.3	1.7	2.2
3	3.9	2	2.6
4	5.2	2.7	3.4
5	6.5	3.3	4
6.3	8	4	5
10	13	7	8
16	20	10	13
20	26	13	16
25	32	17	20
35	46	23	28
50	65	33	40

85°C OxiCap®		105°C OxiCap®	
Rated Voltage V_R	Surge Voltage V_S	Category Voltage V_C	Surge Voltage V_S
1.8	2.3	1.2	1.6
2.5	3.3	1.7	2.2
4	5.2	2.7	3.4
6.3	8	4	5
10	13	7	8

*For THJ 175°C Category & Surge voltage see THJ section on pages 91-93.



1.2.4 Effect of surges

The solid Tantalum and OxiCap® capacitors have a limited ability to withstand voltage and current surges. This is in common with all other electrolytic capacitors and is due to the fact that they operate under very high electrical stress across the dielectric. For example a 6 volt tantalum capacitor has an Electrical Field of 167 kV/mm when operated at rated voltage. OxiCap® capacitors operate at electrical field significantly less than 167 kV/mm.

It is important to ensure that the voltage across the terminals of the capacitor never exceeds the specified surge voltage rating.

Solid tantalum capacitors and OxiCap® have a self healing ability provided by the Manganese Dioxide semiconducting layer used as the negative plate. However, this is limited in low impedance applications. In the case of low impedance circuits, the capacitor is likely to be stressed by current surges.

Derating the capacitor increases the reliability of the component. (See Figure 2b page 135). The “AVX Recommended Derating Table” (page 137) summarizes voltage rating for use on common voltage rails, in low impedance applications for both Tantalum and OxiCap® capacitors.

In circuits which undergo rapid charge or discharge a protective resistor of 1Ω/V is recommended. If this is impossible, a derating factor of up to 70% should be used on tantalum capacitors. OxiCap® capacitors can be used with derating of 20% minimum.

In such situations a higher voltage may be needed than is available as a single capacitor. A series combination should be used to increase the working voltage of the equivalent capacitor: For example, two 22μF 25V parts in series is equivalent to one 11μF 50V part. For further details refer to J.A. Gill's paper “Investigation into the Effects of Connecting Tantalum Capacitors in Series”, available from AVX offices worldwide.

NOTE:

While testing a circuit (e.g. at ICT or functional) it is likely that the capacitors will be subjected to large voltage and current transients, which will not be seen in normal use. These conditions should be borne in mind when considering the capacitor's rated voltage for use. These can be controlled by ensuring a correct test resistance is used.

1.2.5 Reverse voltage and Non-Polar operation.

The values quoted are the maximum levels of reverse voltage which should appear on the capacitors at any time. These limits are based on the assumption that the capacitors are polarized in the correct direction for the majority of their working life. They are intended to cover short term reversals of polarity such as those occurring during switching transients or during a minor portion of an impressed waveform. Continuous application of reverse voltage without normal polarization will result in a degradation of leakage current. In conditions under which continuous application of a reverse

voltage could occur two similar capacitors should be used in a back-to-back configuration with the negative terminations connected together. Under most conditions this combination will have a capacitance one half of the nominal capacitance of either capacitor. Under conditions of isolated pulses or during the first few cycles, the capacitance may approach the full nominal value. The reverse voltage ratings are designed to cover exceptional conditions of small level excursions into incorrect polarity. The values quoted are not intended to cover continuous reverse operation.

The peak reverse voltage applied to the capacitor must not exceed:

- 10% of the rated d.c. working voltage to a maximum of 1.0v at 25°C
- 3% of the rated d.c. working voltage to a maximum of 0.5v at 85°C
- 1% of the rated d.c. working voltage to a maximum of 0.1v at 125°C (0.1v at 150°C THJ Series)

Note: Capacitance and DF values of OxiCap® may exceed specification limits under these conditions.

LEAKAGE CURRENT vs. BIAS VOLTAGE

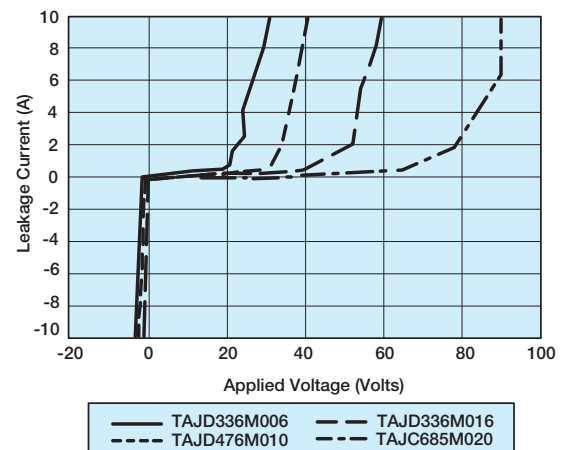

1.2.6 Superimposed A.C. Voltage (Vr.m.s.) - Ripple Voltage.

This is the maximum r.m.s. alternating voltage; superimposed on a d.c. voltage, that may be applied to a capacitor. The sum of the d.c. voltage and peak value of the superimposed a.c. voltage must not exceed the category voltage, v.c.

Full details are given in Section 2.

1.2.7 Forming voltage.

This is the voltage at which the anode oxide is formed. The thickness of this oxide layer is proportional to the formation voltage for a capacitor and is a factor in setting the rated voltage.

1.3 DISSIPATION FACTOR AND TANGENT OF LOSS ANGLE (TAN D)

1.3.1 Dissipation factor (D.F.).

Dissipation factor is the measurement of the tangent of the loss angle ($\tan \delta$) expressed as a percentage. The measurement of DF is carried out using a measuring bridge that supplies a 0.5V rms 120Hz sinusoidal signal, free of harmonics with a bias of 2.2Vdc. The value of DF is temperature and frequency dependent.

Note: For surface mounted products the maximum allowed DF values are indicated in the ratings table and it is important to note that these are the limits met by the component AFTER soldering onto the substrate.

1.3.2 Tangent of Loss Angle ($\tan \delta$).

This is a measurement of the energy loss in the capacitor. It is expressed, as $\tan \delta$ and is the power loss of the capacitor divided by its reactive power at a sinusoidal voltage of specified frequency. Terms also used are power factor, loss factor and dielectric loss. $\cos(90 - \delta)$ is the true power factor. The measurement of $\tan \delta$ is carried out using a measuring bridge that supplies a 0.5V rms 120Hz sinusoidal signal, free of harmonics with a bias of 2.2Vdc.

1.3.3 Frequency dependence of Dissipation Factor.

Dissipation Factor increases with frequency as shown in the typical curves that are for tantalum and OxiCap® capacitors identical:

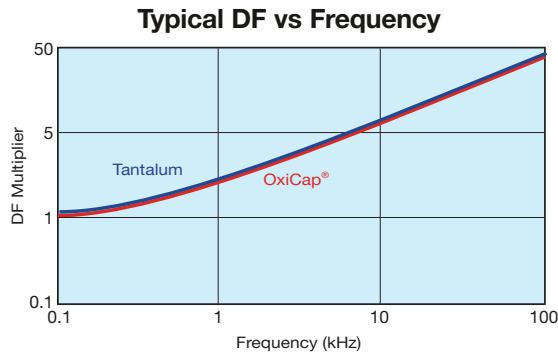

1.3.4 Temperature dependence of Dissipation Factor.

Dissipation factor varies with temperature as the typical curves show. These plots are identical for both Tantalum and OxiCap® capacitors. For maximum limits please refer to ratings tables.

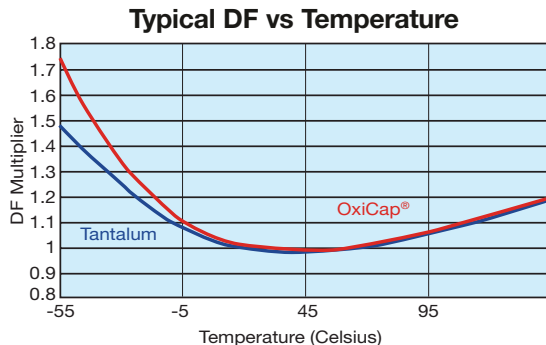

1.4 IMPEDANCE, (Z) AND EQUIVALENT SERIES RESISTANCE (ESR)

1.4.1 Impedance, Z.

This is the ratio of voltage to current at a specified frequency. Three factors contribute to the impedance of a Tantalum capacitor; the resistance of the semiconductor layer; the capacitance value and the inductance of the electrodes and leads.

At high frequencies the inductance of the leads becomes a limiting factor. The temperature and frequency behavior of these three factors of impedance determine the behavior of the impedance Z. The impedance is measured at 25°C and 100kHz.

1.4.2 Equivalent Series Resistance, ESR.

Resistance losses occur in all practical forms of capacitors. These are made up from several different mechanisms, including resistance in components and contacts, viscous forces within the dielectric and defects producing bypass current paths. To express the effect of these losses they are considered as the ESR of the capacitor. The ESR is frequency dependent and can be found by using the relationship;

$$ESR = \frac{\tan \delta}{2\pi f C}$$

Where f is the frequency in Hz, and C is the capacitance in farads.

The ESR is measured at 25°C and 100kHz.

ESR is one of the contributing factors to impedance, and at high frequencies (100kHz and above) it becomes the dominant factor. Thus ESR and impedance become almost identical, impedance being only marginally higher.

1.4.3 Frequency dependence of Impedance and ESR.

ESR and Impedance both increase with decreasing frequency. At lower frequencies the values diverge as the extra contributions to impedance (due to the reactance of the capacitor) become more significant. Beyond 1MHz (and beyond the resonant point of the capacitor) impedance again increases due to the inductance of the capacitor. Typical ESR and Impedance values are similar for both tantalum and niobium oxide materials and thus the same charts are valid for both for Tantalum and OxiCap® capacitors.

Typical ESR vs Frequency

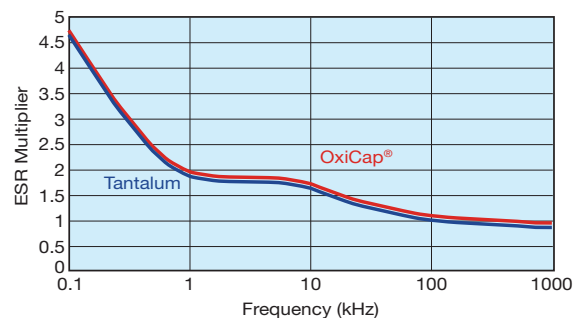

Typical Impedance vs Frequency

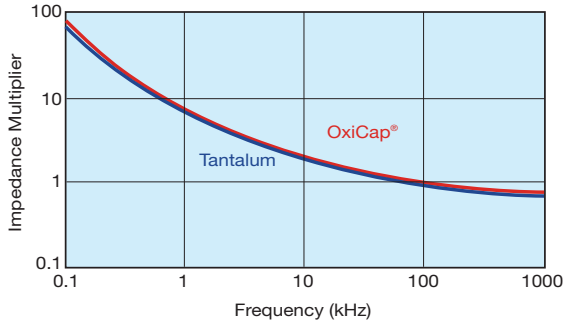

1.4.4 Temperature dependence of the Impedance and ESR.

At 100kHz, impedance and ESR behave identically and decrease with increasing temperature as the typical curves show.

Typical 100kHz ESR vs Temperature

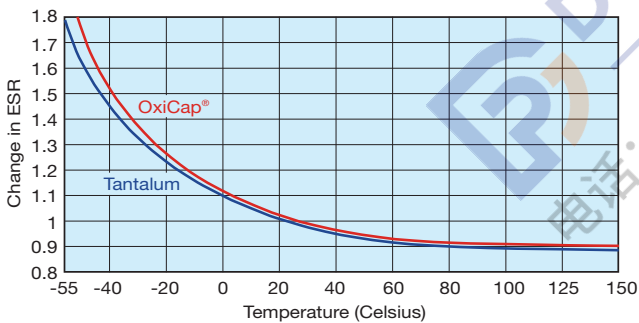

1.5 D.C. LEAKAGE CURRENT

1.5.1 Leakage current.

The leakage current is dependent on the voltage applied, the elapsed time since the voltage was applied and the component temperature. It is measured at +20°C with the rated voltage applied. A protective resistance of 1000Ω is connected in series with the capacitor in the measuring circuit. Three to five minutes after application of the rated voltage the leakage current must not exceed the maximum values indicated in the ratings table. Leakage current is referenced as DCL (for Direct Current Leakage). The default maximum limit for DCL Current is given by $DCL = 0.01CV$, where DCL is in microamperes, and C is the capacitance rating in microfarads, and V is the voltage rating in volts. DCL of tantalum capacitors vary within range of 0.01 - 0.1CV or 0.5μA (whichever is the greater). And 0.02 - 0.1CV or 1.0μA (whichever is the greater) for OxiCap® capacitors.

Reforming of Tantalum or OxiCap® capacitors is unnecessary even after prolonged storage periods without the application of voltage.

1.5.2 Temperature dependence of the leakage current.

The leakage current increases with higher temperatures; typical values are shown in the graph. For operation between 85°C and 125°C, the maximum working voltage must be derated and can be found from the following formula.

$$V_{max} = \left(1 - \frac{T - 85}{125}\right) \times V_R$$

where T is the required operating temperature.

LEAKAGE CURRENT vs. TEMPERATURE

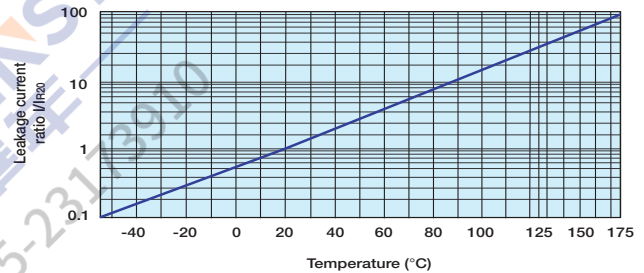

1.5.3 Voltage dependence of the leakage current.

The leakage current drops rapidly below the value corresponding to the rated voltage V_R when reduced voltages are applied. The effect of voltage derating on the leakage current is shown in the graph. This will also give a significant increase in the reliability for any application. See Section 3.1 (page 135) for details.

LEAKAGE CURRENT vs. RATED VOLTAGE

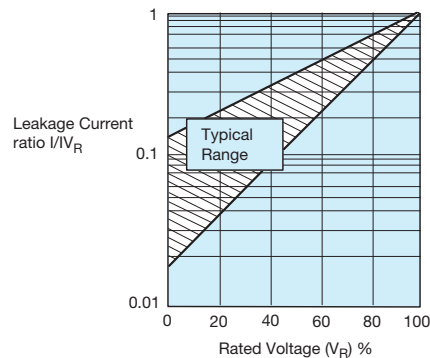

For input condition of fixed application voltage and including median curve of the Leakage current vs. Rated voltage graph displayed above we can evaluate following curve.

Technical Summary and Application Guidelines



LEAKAGE CURRENT MULTIPLIER vs. VOLTAGE DERATING for FIXED APPLICATION VOLTAGE V_A

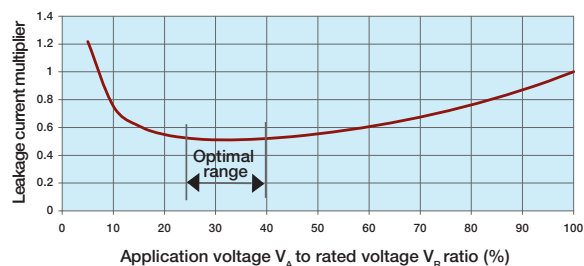

We can identify the range of V_A/V_R (derating) values with minimum actual DCL as the “optimal” range. Therefore the minimum DCL is obtained when capacitor is used at 25 to 40 % of rated voltage - when the rated voltage of the capacitor is 2.5 to 4 times higher than actual application voltage.

For additional information on Leakage Current, please consult the AVX technical publication “Analysis of Solid Tantalum Capacitor Leakage Current” by R. W. Franklin.

1.5.4 Ripple current.

The maximum ripple current allowed is derived from the power dissipation limits for a given temperature rise above ambient temperature (please refer to Section 2, pages 132-134).

1.6 SELF INDUCTANCE (ESL)

The self-inductance value (ESL) can be important for resonance frequency evaluation. See figure below typical ESL values per case size.

TAJ/TPS/TRJ/THJ/TAW/TLJ/TCJ/NLJ/NOJ/NOS

Case Size	Typical Self Inductance value (nH)	Case Size	Typical Self Inductance value (nH)	Case Size	Typical Self Inductance value (nH)
A	1.8	H	1.8	U	2.4
B	1.8	K	1.8	V	2.4
C	2.2	N	1.4	W	2.2
D	2.4	P	1.4	X	2.4
E	2.5	R	1.4	Y	2.4
F	2.2	S	1.8		
G	1.8	T	1.8		

TAC/TLC/TPC

Case Size	Typical Self-Inductance value (nH)
K	1.1
L	1.2
R	1.4

TCM/TPM TRM/NOM

Case Size	Typical Self-Inductance value (nH)
D	1.0
E	2.5
V	2.4
Y	1.0

TLN/TCN

Case Size	Typical Self-Inductance value (nH)
K	1.0
L	1.0
S	1.0
T	1.0
4	2.2
6	2.5

SECTION 2

A.C. OPERATION, RIPPLE VOLTAGE AND RIPPLE CURRENT

2.1 RIPPLE RATINGS (A.C.)

In an a.c. application heat is generated within the capacitor by both the a.c. component of the signal (which will depend upon the signal form, amplitude and frequency), and by the d.c. leakage. For practical purposes the second factor is insignificant. The actual power dissipated in the capacitor is calculated using the formula:

$$P = I^2 R$$

and rearranged to $I = \text{SQRT}(P/R)$ (Eq. 1)

where I = rms ripple current, amperes
 R = equivalent series resistance, ohms
 U = rms ripple voltage, volts
 P = power dissipated, watts
 Z = impedance, ohms, at frequency under consideration

Maximum a.c. ripple voltage (U_{max}).

From the Ohms' law equation:

$$U_{\text{max}} = IR \text{(Eq. 2)}$$

Where P is the maximum permissible power dissipated as listed for the product under consideration (see tables).

However care must be taken to ensure that:

1. The d.c. working voltage of the capacitor must not be exceeded by the sum of the positive peak of the applied a.c. voltage and the d.c. bias voltage.
2. The sum of the applied d.c. bias voltage and the negative peak of the a.c. voltage must not allow a voltage reversal in excess of the "Reverse Voltage".

Historical ripple calculations.

Previous ripple current and voltage values were calculated using an empirically derived power dissipation required to give a 10°C rise of the capacitors body temperature from room temperature, usually in free air. These values are shown in Table I. Equation 1 then allows the maximum ripple current to be established, and Equation 2, the maximum ripple voltage. But as has been shown in the AVX article on thermal management by I. Salisbury, the thermal conductivity of a Tantalum chip capacitor varies considerably depending upon how it is mounted.

Table I: Power Dissipation Ratings (In Free Air)

TAJ/TPS/TPM/TRJ/TRM/THJ/TAW/TLJ/TLN/TCJ/TCM
TCN/NLJ/NOJ/NOS/NOM Series Molded Chip

Case size	Max. power dissipation (W)				
	Tantalum			OxiCap®	
	TAJ/TPS/TRJ/THJ/TAW/TLJ/TCJ	TLN TCN	TPM TRM TCM	NLJ NOJ NOS	NOM
A	0.075	—	—	0.090	—
B	0.085	—	—	0.102	—
C	0.110	—	—	0.132	—
D	0.150	—	0.255	0.180	—
E	0.165	—	0.270	0.198	0.324
F	0.100	—	—	0.120	—
G	0.070	0.060	—	0.084	—
H	0.080	0.070	—	0.096	—
K	0.065	0.055	—	0.078	—
L	0.070	0.060	—	0.084	—
M	—	0.040	—	—	—
N	0.050	0.040	—	—	—
P	0.060	—	—	0.072	—
R	0.055	0.045	—	0.066	—
S	0.065	0.055	—	0.078	—
T	0.080	0.070	—	0.096	—
U	0.165	—	—	—	—
V	0.250	—	0.285	0.300	—
W	0.090	—	—	0.108	—
X	0.100	—	—	0.120	—
Y	0.125	0.115	0.210	0.150	—
Z	—	—	0.300	—	—
4	—	0.165	—	—	—
6	—	0.230	—	—	—

TACmicrochip®

Case size	Max. power dissipation (W)
A	0.040
B	0.040
H	0.040
J	0.020
K	0.015
L	0.025
M	0.030
Q	0.040
R	0.045
T	0.040
U	0.035
V	0.035
X	0.040
Z	0.020

NLJ/NOJ/NOS/NOM

Temperature correction factor for ripple current	
Temp. °C	Factor
+25	1.00
+55	0.95
+85	0.90
+105	0.40
+125 (NOS,NOM)	0.40

TAJ/TPS/TPM/TRJ/TRM/THJ/TAW
TLJ/TLN/TCJ/TCM/TCN

Temp °C	Correction Factor for ripple current	Correction Factor for Power Dissipation	Max. Temperature rise °C
+25	1.00	1.00	10
+55	0.95	0.90	9
+85	0.90	0.81	8.1
+105	0.65	0.42	4.2
+115	0.49	0.24	2.4
+125	0.40	0.16	1.6
+175 (THJ)	0.20	0.04	0.4
+200 (THJ)	0.10	0.01	0.1

Technical Summary and Application Guidelines



A piece of equipment was designed which would pass sine and square wave currents of varying amplitudes through a biased capacitor. The temperature rise seen on the body for the capacitor was then measured using an infra-red probe. This ensured that there was no heat loss through any thermo-couple attached to the capacitor's surface.

Results for the C, D and E case sizes

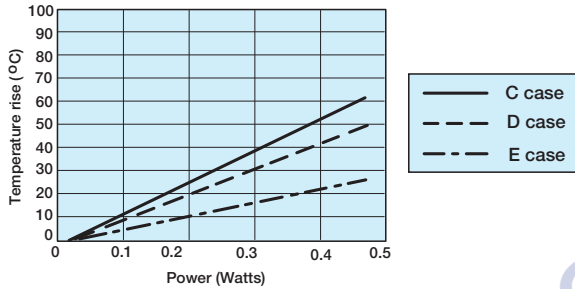

Several capacitors were tested and the combined results are shown above. All these capacitors were measured on FR4 board, with no other heat sinking. The ripple was supplied at various frequencies from 1kHz to 1MHz.

As can be seen in the figure above, the average P_{max} value for the C case capacitors was 0.11 Watts. This is the same as that quoted in Table I.

The D case capacitors gave an average P_{max} value 0.125 Watts. This is lower than the value quoted in the Table I by 0.025 Watts. The E case capacitors gave an average P_{max} of 0.200 Watts that was much higher than the 0.165 Watts from Table I.

If a typical capacitor's ESR with frequency is considered, e.g. figure below, it can be seen that there is variation. Thus for a set ripple current, the amount of power to be dissipated by the capacitor will vary with frequency. This is clearly shown in figure in top of next column, which shows that the surface temperature of the unit raises less for a given value of ripple current at 1MHz than at 100kHz.

The graph below shows a typical ESR variation with frequency. Typical ripple current versus temperature rise for 100kHz and 1MHz sine wave inputs.

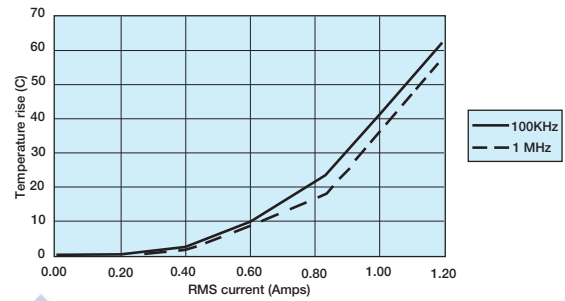
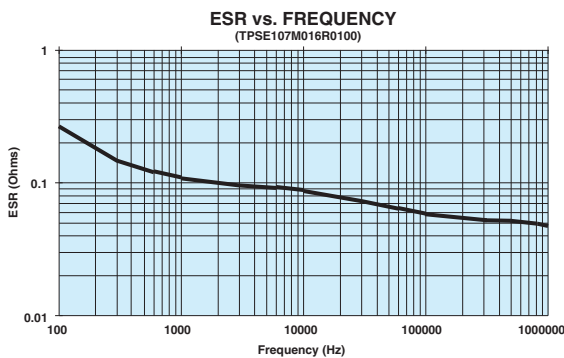

If I^2R is then plotted it can be seen that the two lines are in fact coincident, as shown in figure below.

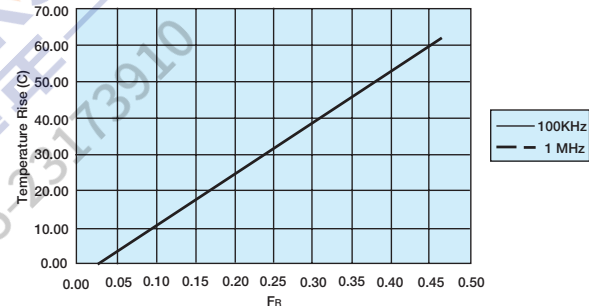

Example

A Tantalum capacitor is being used in a filtering application, where it will be required to handle a 2 Amp peak-to-peak, 200kHz square wave current.

A square wave is the sum of an infinite series of sine waves at all the odd harmonics of the square waves fundamental frequency. The equation which relates is:

$$I_{square} = I_{pk} \sin(2\pi f) + I_{pk} \sin(6\pi f) + I_{pk} \sin(10\pi f) + I_{pk} \sin(14\pi f) + \dots$$

Thus the special components are:

Frequency	Peak-to-peak current (Amps)	RMS current (Amps)
200 KHz	2.000	0.707
600 KHz	0.667	0.236
1 MHz	0.400	0.141
1.4 MHz	0.286	0.101

Let us assume the capacitor is a TAJD686M006
Typical ESR measurements would yield.

Frequency	Typical ESR (Ohms)	Power (Watts) $I_{rms}^2 \times ESR$
200 KHz	0.120	0.060
600 KHz	0.115	0.006
1 MHz	0.090	0.002
1.4 MHz	0.100	0.001

Thus the total power dissipation would be 0.069 Watts.

From the D case results shown in figure top of previous column, it can be seen that this power would cause the capacitors surface temperature to rise by about 5°C. For additional information, please refer to the AVX technical publication "Ripple Rating of Tantalum Chip Capacitors" by R.W. Franklin.

Technical Summary and Application Guidelines



2.2 OXICAP RIPPLE RATING

OxiCap® capacitors showing 20% higher power dissipation allowed compared to tantalum capacitors as a result of twice higher specific heat of niobium oxide compared to Tantalum

powders. (Specific heat is related to energy necessary to heat a defined volume of material to a specified temperature.)

2.3 THERMAL MANAGEMENT

The heat generated inside a tantalum capacitor in a.c. operation comes from the power dissipation due to ripple current. It is equal to I^2R , where I is the rms value of the current at a given frequency, and R is the ESR at the same frequency with an additional contribution due to the leakage current. The heat will be transferred from the outer surface by conduction. How efficiently it is transferred from this point is dependent on the thermal management of the board.

In practice, in a high density assembly with no specific thermal management, the power dissipation required to give a 10°C rise above ambient may be up to a factor of 10 less. In these cases, the actual capacitor temperature should be established (either by thermocouple probe or infra-red scanner) and if it is seen to be above this limit it may be necessary to specify a lower ESR part or a higher voltage rating.

The power dissipation ratings given in Section 2.1 (page 132) are based on free-air calculations. These ratings can be approached if efficient heat sinking and/or forced cooling is used.

Please contact application engineering for details or contact the AVX technical publication entitled “Thermal Management of Surface Mounted Tantalum Capacitors” by Ian Salisbury.

Thermal Dissipation from the Mounted Chip

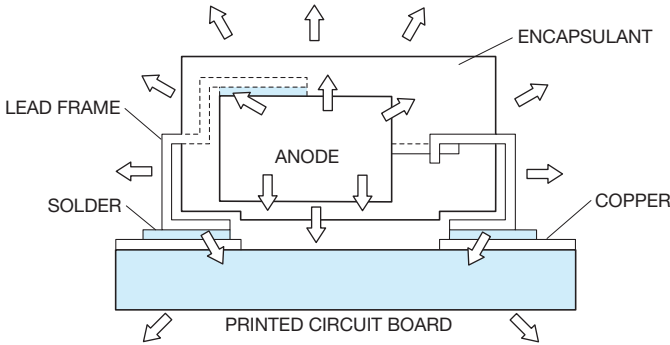

Thermal Impedance Graph with Ripple Current

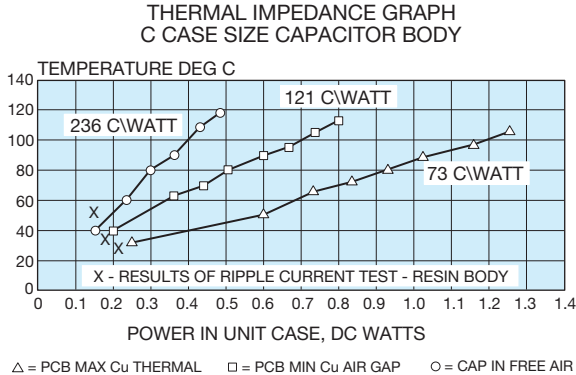

SECTION 3 RELIABILITY AND CALCULATION OF FAILURE RATE

3.1 STEADY-STATE

Both Tantalum and Niobium Oxide dielectric have essentially no wear out mechanism and in certain circumstances is capable of limited self healing. However, random failures can occur in operation. The failure rate of Tantalum capacitors will decrease with time and not increase as with other electrolytic capacitors and other electronic components.

Figure 1. Tantalum and OxiCap® Reliability Curve

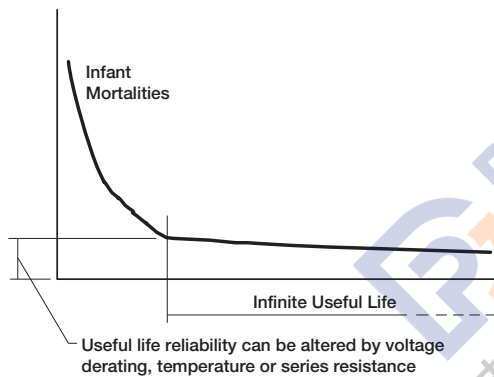

The useful life reliability of the Tantalum and OxiCap® capacitors in steady-state is affected by three factors. The equation from which the failure rate can be calculated is:

$$F = F_V \times F_T \times F_R \times F_B$$

where F_V is a correction factor due to operating voltage/voltage derating

F_T is a correction factor due to operating temperature

F_R is a correction factor due to circuit series resistance

F_B is the basic failure rate level

Base failure rate.

Standard Tantalum conforms to Level M reliability (i.e. 1%/1000 hrs) or better at rated voltage, 85°C and 0.1Ω/volt circuit impedance.

$F_B = 1.0\% / 1000$ hours for TAJ, TPS, TPM, TAW, TCJ, TCM, TCN, TAC

0.5% / 1000 hours for TRJ, TRM, THJ and NOJ

0.2% / 1000 hours for NOS and NOM

TLJ, TLN, TLC and NLJ series of tantalum capacitors are defined at 0.5 x rated voltage at 85°C due to the temperature derating.

$F_B = 0.2\% / 1000$ hours at 85°C and $0.5 \times V_R$ with 0.1Ω/V series impedance with 60% confidence level.

Operating voltage/voltage derating.

If a capacitor with a higher voltage rating than the maximum line voltage is used, then the operating reliability will be improved. This is known as voltage derating.

The graph, Figure 2a, shows the relationship between voltage derating (the ratio between applied and rated voltage) and the failure rate. The graph gives the correction factor F_V for any operating voltage.

Figure 2a. Correction factor to failure rate F_V for voltage derating of a typical component (60% con. level).

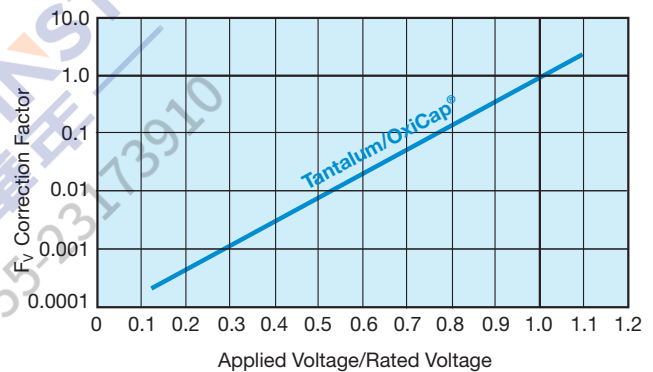

Figure 2b. Gives our recommendation for voltage derating for tantalum capacitors to be used in typical applications.

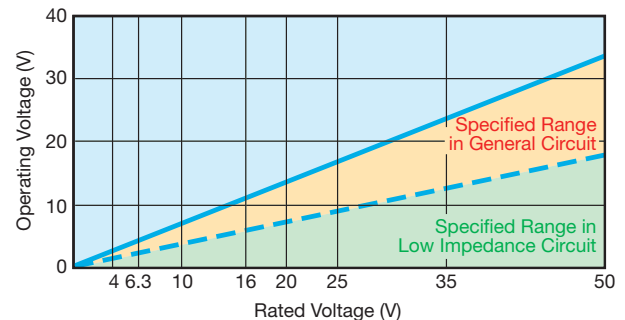
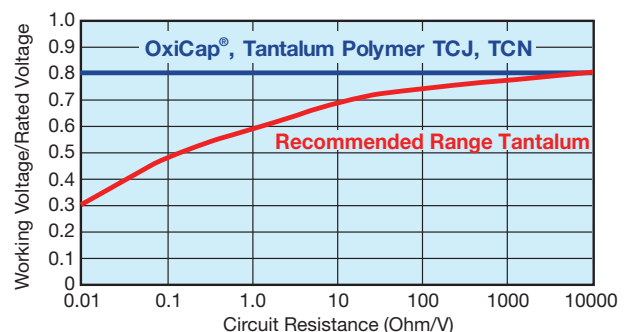

Figure 2c. Gives voltage derating recommendations for tantalum capacitors as a function of circuit impedance.



Technical Summary and Application Guidelines



Operating Temperature.

If the operating temperature is below the rated temperature for the capacitor then the operating reliability will be improved as shown in Figure 3. This graph gives a correction factor F_T for any temperature of operation.

Figure 3: Correction factor to failure rate F_R for ambient temperature T for typical component (60% con. level).

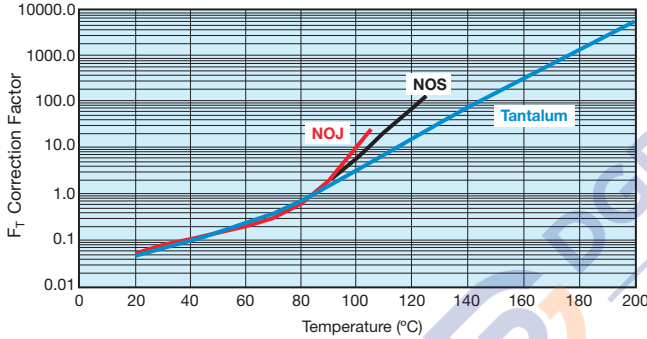

Circuit Impedance.

All solid Tantalum and/or niobium oxide capacitors require current limiting resistance to protect the dielectric from surges. A series resistor is recommended for this purpose. A lower circuit impedance may cause an increase in failure rate, especially at temperatures higher than 20°C. An inductive low impedance circuit may apply voltage surges to the capacitor and similarly a non-inductive circuit may apply current surges to the capacitor, causing localized over-heating and failure. The recommended impedance is 1 Ω per volt. Where this is not feasible, equivalent voltage derating should be used (See MIL HANDBOOK 217E). The graph, Figure 4, shows the correction factor, F_R , for increasing series resistance.

Figure 4. Correction factor to failure rate F_R for series resistance R on basic failure rate F_B for a typical component (60% con. level).

Circuit resistance ohms/volt	F_R
3.0	0.07
2.0	0.1
1.0	0.2
0.8	0.3
0.6	0.4
0.4	0.6
0.2	0.8
0.1	1.0

For circuit impedances below 0.1 ohms per volt, or for any mission critical application, circuit protection should be considered. An ideal solution would be to employ an AVX SMT thin-film fuse in series.

Example calculation.

Consider a 12 volt power line. The designer needs about 10μF of capacitance to act as a decoupling capacitor near a video bandwidth amplifier. Thus the circuit impedance will be limited only by the output impedance of the board's power unit and the track resistance. Let us assume it to be about 2 Ohms minimum, i.e. 0.167 Ohms/Volt. The operating temperature range is -25°C to +85°C.

If a 10μF 16 Volt capacitor was designed in the operating failure rate would be as follows.

- a) $F_T = 1.0$ @ 85°C
- b) $F_R = 0.85$ @ 0.167 Ohms/Volt
- c) $F_V = 0.08$ @ applied voltage/rated voltage = 75%
- d) $F_B = 1\%/1000$ hours, basic failure rate level

Thus $F = 1.0 \times 0.85 \times 0.08 \times 1 = 0.068\%/1000$ Hours
 If the capacitor was changed for a 20 volt capacitor, the operating failure rate will change as shown.

$F_V = 0.018$ @ applied voltage/rated voltage = 60%
 $F = 1.0 \times 0.85 \times 0.018 \times 1 = 0.0153\%/1000$ Hours

3.2 Dynamic.

As stated in Section 1.2.4 (page 128), the solid capacitor has a limited ability to withstand voltage and current surges. Such current surges can cause a capacitor to fail. The expected failure rate cannot be calculated by a simple formula as in the case of steady-state reliability. The two parameters under the control of the circuit design engineer known to reduce the incidence of failures are derating and series resistance.

The table below summarizes the results of trials carried out at AVX with a piece of equipment, which has very low series resistance with no voltage derating applied. That is if the capacitor was tested at its rated voltage. It has been tested on tantalum capacitors, however the conclusions are valid for both tantalum and OxiCap® capacitors.

Results of production scale derating experiment

Capacitance and Voltage	Number of units tested	50% derating applied	No derating applied
47μF 16V	1,547,587	0.03%	1.1%
100μF 10V	632,876	0.01%	0.5%
22μF 25V	2,256,258	0.05%	0.3%

As can clearly be seen from the results of this experiment, the more derating applied by the user, the less likely the probability of a surge failure occurring.

It must be remembered that these results were derived from a highly accelerated surge test machine, and failure rates in the low ppm are more likely with the end customer.

A commonly held misconception is that the leakage current of a Tantalum capacitor can predict the number of failures which will be seen on a surge screen. This can be disproved by the results of an experiment carried out at AVX on 47μF



Technical Summary and Application Guidelines



10V surface mount capacitors with different leakage currents. The results are summarized in the table below.

Leakage current vs number of surge failures.

Again, it must be remembered that these results were derived from a highly accelerated surge test machine, and failure rates in the low ppm are more likely with the end customer.

	Number tested	Number failed surge
Standard leakage range 0.1 μ A to 1 μ A	10,000	25
Over Catalog limit 5 μ A to 50 μ A	10,000	26
Classified Short Circuit 50 μ A to 500 μ A	10,000	25

OxiCap[®] capacitor is less sensitive to an overloading stress compared to Tantalum and so a 20% minimum derating is recommended. It may be necessary in extreme low impedance circuits of high transient or 'switch-on' currents to derate the voltage further. Hence in general a lower voltage OxiCap[®] part number can be placed on a higher rail voltage compared to the tantalum capacitor – see table below.

AVX recommended derating table.

Voltage Rail (V)	Rated Voltage of Cap (V)	
	Tantalum	OxiCap [®]
3.3	6.3	4
5	10	6.3
8	16	10
10	20	–
12	25	–
15	35	–
>24	Series Combination	–

For further details on surge in Tantalum capacitors refer to J.A. Gill's paper "Surge in Solid Tantalum Capacitors", available from AVX offices worldwide.

An added bonus of increasing the derating applied in a circuit, to improve the ability of the capacitor to withstand surge conditions, is that the steady-state reliability is improved by up to an order. Consider the example of a 6.3 volt capacitor being used on a 5 volt rail.

The steady-state reliability of a Tantalum capacitor is affected by three parameters; temperature, series resistance and voltage derating. Assume 40°C operation and 0.1 Ohms/Volt series resistance.

The capacitors reliability will therefore be:

$$\begin{aligned} \text{Failure rate} &= F_U \times F_T \times F_R \times 1\%/1000 \text{ hours} \\ &= 0.15 \times 0.1 \times 1 \times 1\%/1000 \text{ hours} \\ &= 0.015\%/1000 \text{ hours} \end{aligned}$$

If a 10 volt capacitor was used instead, the new scaling factor would be 0.006, thus the steady-state reliability would be:

$$\begin{aligned} \text{Failure rate} &= F_U \times F_T \times F_R \times 1\%/1000 \text{ hours} \\ &= 0.006 \times 0.1 \times 1 \times 1\%/1000 \text{ hours} \\ &= 6 \times 10^{-4} \%/1000 \text{ hours} \end{aligned}$$

So there is an order improvement in the capacitors steady-state reliability.

Technical Summary and Application Guidelines



SECTION 4 RECOMMENDED SOLDERING CONDITIONS

Both Tantalum and OxiCap® are lead-free system compatible components, meeting requirements of J-STD-020 standard. The maximum conditions with care: Max. Peak Temperature: 260°C for maximum 10s, 3 reflow cycles. 2 cycles are allowed for F-series capacitors.

Small parametric shifts may be noted immediately after reflow, components should be allowed to stabilize at room temperature prior to electrical testing.

RECOMMENDED REFLOW PROFILE

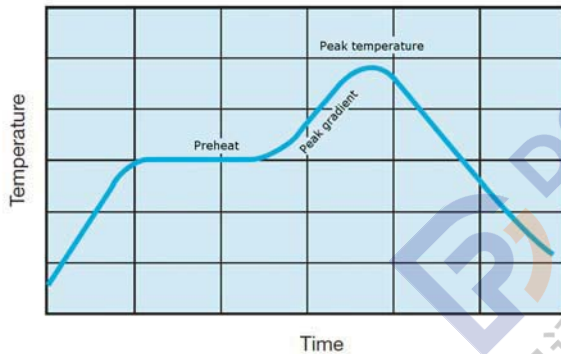

Lead-free soldering:

Pre-heating: 150±15°C/60–120sec.
Max. Peak Temperature: 245±5°C
Max. Peak Temperature Gradient: 2.5°C/sec.
Max. Time above 230°C: 40sec. max.

SnPb soldering:

Pre-heating: 150±15°C/60–90sec.
Max. Peak Temperature: 220±5°C
Max. Peak Temperature Gradient: 2°C/sec.
Max. Time above solder melting point: 60sec.

RECOMMENDED WAVE SOLDERING

Lead-free soldering:

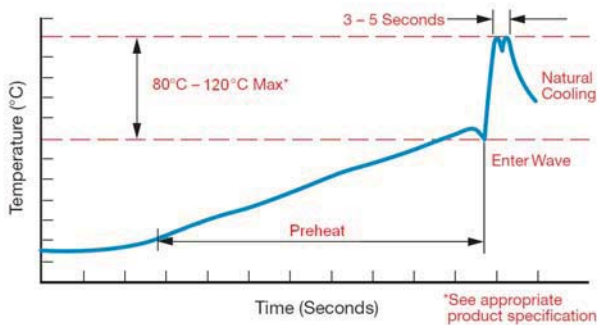

Pre-heating: 50-165°C/90-120sec.
Max. Peak Temperature: 250-260°C
Time of wave: 3-5sec.(max. 10sec.)

SnPb soldering:

Pre-heating: 50-165°C/90–120sec.
Max. Peak Temperature: 240-250°C
Time of wave: 3-5sec.(max.10sec.)

The upper side temperature of the board should not exceed +150°C.

GENERAL LEAD-FREE NOTES

The following should be noted by customers changing from lead based systems to the new lead free pastes.

- The visual standards used for evaluation of solder joints will need to be modified as lead-free joints are not as bright as with tin-lead pastes and the fillet may not be as large.
- Resin color may darken slightly due to the increase in temperature required for the new pastes.
- Lead-free solder pastes do not allow the same self alignment as lead containing systems. Standard mounting pads are acceptable, but machine set up may need to be modified.

Note: TLN, TCN and F98 series are not dedicated to wave soldering.

RECOMMENDED HAND SOLDERING

Recommended hand soldering condition:

Tip Diameter	Selected to fit Application
Max. Tip Temperature	+370°C
Max. Exposure Time	3s
Anti-static Protection	Non required

Note: TLN and TCN series are not dedicated to hand soldering.

SECTION 5 TERMINATIONS

5.1 Basic Materials

Two basic materials are used for termination leads: Nilo 42 (Fe58Ni42) and copper. Copper lead frame is mainly used for products requiring low ESR performance, while Nilo 42 is used for other products. The actual status of basic material per individual part type can be checked with AVX.

5.2 Termination Finishes – Coatings

Three terminations plating are available. Standard plating material is pure matte tin (Sn). Gold or tin-lead (SnPb) are available upon request with different part number suffix designations.*

5.2.1. Pure matte tin is used as the standard coating material meeting lead-free and RoHS requirements. AVX carefully monitors the latest findings on prevention of whisker formation. Currently used techniques include use of matte tin electrodeposition, nickel barrier underplating and recrystallization of surface by reflow. Terminations are tested for whiskers according to NEMI recommendations and JEDEC standard requirements. Data is available upon request.

5.2.2. Gold Plating is available as a special option* mainly for hybrid assembly using conductive glue.

5.2.3. Tin-lead (90%Sn 10%Pb) electroplated termination finish is available as a special option* upon request.

* Some plating options can be limited to specific part types. Please check availability of special options with AVX.

Technical Summary and Application Guidelines



SECTION 6 MECHANICAL AND THERMAL PROPERTIES OF CAPACITORS

6.1 Acceleration

98.1m/s² (10g)

6.2 Vibration Severity

10 to 2000Hz, 0.75mm of 98.1m/s² (10g)

6.3 Shock

Trapezoidal Pulse, 98.1m/s² for 6ms.

6.4 Adhesion to Substrate

IEC 384-3. minimum of 5N.

6.5 Resistance to Substrate Bending

The component has compliant leads which reduces the risk of stress on the capacitor due to substrate bending.

6.6 Soldering Conditions

Dip soldering is permissible provided the solder bath temperature is $\leq 270^{\circ}\text{C}$, the solder time < 3 seconds and the circuit board thickness $\geq 1.0\text{mm}$.

6.7 Installation Instructions

The upper temperature limit (maximum capacitor surface temperature) must not be exceeded even under the most unfavorable conditions when the capacitor is installed. This must be considered particularly when it is positioned near components which radiate heat strongly (e.g. valves and power transistors). Furthermore, care must be taken, when bending the wires, that the bending forces do not strain the capacitor housing.

6.8 Installation Position

No restriction.

6.9 Soldering Instructions

Fluxes containing acids must not be used.

6.9.1 Guidelines for Surface Mount Footprints

Component footprint and reflow pad design for AVX capacitors.

The component footprint is defined as the maximum board area taken up by the terminators. The footprint dimensions are given by A, B, C and D in the diagram, which corresponds to W, max., A max., S min. and L max. for the component. The footprint is symmetric about the center lines.

The dimensions x, y and z should be kept to a minimum to reduce rotational tendencies while allowing for visual inspection of the component and its solder fillet.

Dimensions PS (c for F-series) (Pad Separation) and PW (a for F-series) (Pad Width) are calculated using dimensions x and z. Dimension y may vary, depending on whether reflow or wave soldering is to be performed.

For reflow soldering, dimensions PL (b for positive terminal of F-series; b' for negative terminal of F-series) (Pad Length), PW (a) (Pad Width), and PSL (Pad Set Length) have been calculated. For wave soldering the pad width (PWw) is reduced to less than the termination width to minimize the amount of solder pick up while ensuring that a good joint can be produced. In the case of mounting conformal coated capacitors, excentering (Δc) is needed to except anode tab [△].

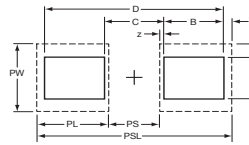

NOTE: These recommendations (also in compliance with EIA) are guidelines only. With care and control, smaller footprints may be considered for reflow soldering.

Nominal footprint and pad dimensions for each case size are given in the following tables:

PAD DIMENSIONS: millimeters (inches)

Case Size	PSL	PL	PS	PW	PWw
Series	A	B	C	D	
A	4.00 (0.157)	1.40 (0.054)	1.20 (0.047)	1.80 (0.071)	0.90 (0.035)
B	4.00 (0.157)	1.40 (0.054)	1.20 (0.047)	2.80 (0.110)	1.60 (0.063)
C	6.50 (0.256)	2.00 (0.079)	2.50 (0.098)	2.80 (0.110)	1.60 (0.063)
D	8.00 (0.315)	2.00 (0.079)	4.00 (0.157)	3.00 (0.119)	1.70 (0.068)
E	8.00 (0.315)	2.00 (0.079)	4.00 (0.157)	3.00 (0.119)	1.70 (0.068)
F	6.50 (0.256)	2.00 (0.079)	2.50 (0.098)	2.80 (0.110)	1.60 (0.063)
G	4.00 (0.157)	1.40 (0.054)	1.20 (0.047)	1.80 (0.071)	0.90 (0.035)
H	4.00 (0.157)	1.40 (0.054)	1.20 (0.047)	2.80 (0.110)	1.60 (0.063)
K	4.00 (0.157)	1.40 (0.054)	1.20 (0.047)	1.80 (0.071)	0.90 (0.035)
L	4.00 (0.157)	1.40 (0.054)	1.20 (0.047)	2.80 (0.110)	1.60 (0.063)
N	2.70 (0.100)	0.95 (0.037)	0.80 (0.030)	1.60 (0.060)	0.80 (0.030)
P	2.70 (0.100)	0.95 (0.037)	0.80 (0.030)	1.60 (0.060)	0.80 (0.030)
R	2.70 (0.100)	0.95 (0.037)	0.80 (0.030)	1.60 (0.060)	0.80 (0.030)
S	4.00 (0.157)	1.40 (0.054)	1.20 (0.047)	1.80 (0.071)	0.90 (0.035)
T	4.00 (0.157)	1.40 (0.054)	1.20 (0.047)	2.80 (0.110)	1.60 (0.063)
U	8.00 (0.315)	2.00 (0.079)	4.00 (0.157)	3.70 (0.145)	1.80 (0.071)
V	8.00 (0.315)	2.00 (0.079)	4.00 (0.157)	3.70 (0.145)	1.80 (0.071)
W	6.50 (0.256)	2.00 (0.079)	2.50 (0.098)	2.80 (0.110)	1.60 (0.063)
X	8.00 (0.315)	2.00 (0.079)	4.00 (0.157)	3.00 (0.119)	1.70 (0.068)
Y	8.00 (0.315)	2.00 (0.079)	4.00 (0.157)	3.00 (0.119)	1.70 (0.068)
Z	8.00 (0.315)	2.00 (0.079)	4.00 (0.157)	3.70 (0.145)	1.80 (0.071)
TLN & TCN Undertab	M	N	S	T	
M	3.50 (0.138)	1.15 (0.045)	1.20 (0.047)	2.40 (0.094)	N/A
N	2.30 (0.091)	0.90 (0.035)	0.50 (0.020)	1.10 (0.043)	N/A
S	3.50 (0.138)	1.15 (0.045)	1.20 (0.047)	1.20 (0.047)	N/A
T	3.50 (0.138)	1.15 (0.045)	1.20 (0.047)	2.40 (0.094)	N/A
Y	7.20 (0.283)	1.50 (0.059)	4.20 (0.165)	2.50 (0.098)	N/A
4	7.40 (0.291)	2.20 (0.087)	3.00 (0.118)	4.80 (0.190)	N/A
6	15.20 (0.598)	3.00 (0.120)	9.20 (0.360)	5.50 (0.217)	N/A
TACMicro-chip®	A	B	C	H	J
A	4.40 (0.173)	1.60 (0.063)	1.20 (0.047)	1.80 (0.071)	0.90 (0.035)
B	4.70 (0.185)	1.70 (0.070)	1.30 (0.051)	3.00 (0.118)	1.50 (0.059)
C	4.40 (0.173)	1.60 (0.063)	1.20 (0.047)	1.80 (0.071)	0.90 (0.035)
H	3.20 (0.126)	1.30 (0.051)	0.60 (0.024)	1.50 (0.059)	0.075 (0.375)
J	2.80 (0.110)	1.10 (0.043)	0.60 (0.024)	1.00 (0.039)	0.50 (0.020)
K	2.20 (0.087)	0.90 (0.035)	0.40 (0.016)	0.70 (0.028)	0.35 (0.014)
L	2.80 (0.110)	1.10 (0.043)	0.60 (0.024)	1.00 (0.039)	0.50 (0.020)
M	3.20 (0.126)	1.30 (0.051)	0.60 (0.024)	1.00 (0.039)	0.50 (0.020)
Q	3.20 (0.126)	1.30 (0.051)	0.60 (0.024)	1.50 (0.059)	0.075 (0.375)
R	3.20 (0.126)	1.30 (0.051)	0.60 (0.024)	1.50 (0.059)	0.075 (0.375)
S	4.40 (0.173)	1.60 (0.063)	1.20 (0.047)	1.80 (0.071)	0.90 (0.035)
T	4.70 (0.185)	1.70 (0.070)	1.30 (0.051)	3.00 (0.118)	1.50 (0.059)
U	3.20 (0.126)	1.30 (0.051)	0.60 (0.024)	1.50 (0.059)	0.075 (0.375)
V	4.40 (0.173)	1.60 (0.063)	1.20 (0.047)	1.80 (0.071)	0.90 (0.035)
Z	2.80 (0.110)	1.10 (0.043)	0.60 (0.024)	0.70 (0.028)	0.35 (0.014)

Note: SMD 'J' Lead = TAJ, TPS, TPM, TRJ, TRM, THJ, TAW, TLJ, TCJ, TCM

PAD DIMENSIONS F-SERIES: millimeters (inches)

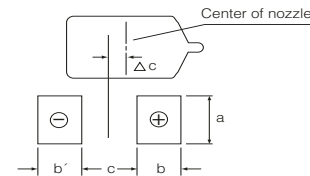

Case Size	a	b	b'	c	Δc^*	
Series	M	U	S	A	B	
M	0.35 (0.014)	0.40 (0.016)	0.40 (0.016)	0.40 (0.016)	0.00	
U	0.65 (0.026)	0.70 (0.028)	0.70 (0.030)	0.60 (0.024)	0.00	
S	0.90 (0.035)	0.70 (0.028)	0.70 (0.030)	0.80 (0.032)	0.00	
A	1.00 (0.039)	1.10 (0.043)	1.10 (0.043)	0.40 (0.016)	0.00	
B	1.30 (0.051)	1.40 (0.060)	1.40 (0.055)	1.00 (0.039)	0.00	
B	2.30 (0.091)	1.40 (0.060)	1.40 (0.055)	1.30 (0.051)	0.00	
C	2.30 (0.091)	2.00 (0.079)	2.00 (0.079)	2.70 (0.106)	0.00	
N	2.30 (0.091)	2.00 (0.079)	2.00 (0.079)	4.00 (0.158)	0.00	
R-P	1.40 (0.055)	0.60 (0.024)	0.50 (0.020)	0.70 (0.028)	+0.20 (0.008)	
Q-S	1.70 (0.067)	0.70 (0.028)	0.60 (0.024)	1.10 (0.043)	+0.20 (0.008)	
F95, AUDIO F95 Conformal	A	T	B			
A	1.80 (0.071)	0.70 (0.028)	0.60 (0.024)	1.10 (0.043)	+0.20 (0.008)	
T	2.60 (0.102)	0.70 (0.028)	0.60 (0.024)	1.20 (0.047)	+0.20 (0.008)	
B	2.60 (0.102)	0.80 (0.032)	0.70 (0.030)	1.10 (0.043)	+0.20 (0.008)	
F72 Conformal	R-M	5.80 (0.228)	1.20 (0.047)	1.20 (0.047)	3.90 (0.154)	0.50 (0.020)
F75 Conformal	U-C	D	R			
U-C	3.00 (0.118)	1.20 (0.047)	1.20 (0.047)	3.30 (0.130)	0.50 (0.020)	
D	4.10 (0.161)	1.20 (0.047)	1.20 (0.047)	3.90 (0.154)	0.50 (0.020)	
R	5.80 (0.228)	1.20 (0.047)	1.20 (0.047)	3.90 (0.154)	0.50 (0.020)	

*In the case of mounting conformal coated capacitors, excentering (Δc) is needed to except anode tab [△].



Technical Summary and Application Guidelines



6.10 PCB Cleaning

Ta chip capacitors are compatible with most PCB board cleaning systems.

If aqueous cleaning is performed, parts must be allowed to dry prior to test. In the event ultrasonics are used power levels should be less than 10 watts per/litre, and care must be taken to avoid vibrational nodes in the cleaning bath.

SECTION 7: EPOXY FLAMMABILITY

EPOXY	UL RATING	OXYGEN INDEX
TAJ/TPS/TPM/TRJ/TRM/THJ TAW/TLJ/TLN/TCJ/TCM/TCN NLJ/NOJ/NOS/NOM	UL94 V-0	35%

SECTION 8: QUALIFICATION APPROVAL STATUS

DESCRIPTION	STYLE	SPECIFICATION
Surface mount capacitors	TAJ	CECC 30801 - 005 Issue 2 CECC 30801 - 011 Issue 1

PHNST
— 華年 —
电话: 0755-23173910

Material Data and Handling

This should be read in conjunction with the Product Datasheet. Failure to observe the ratings and the information on this sheet may result in a safety hazard.

1. Material Content

Solid Tantalum and OxiCap® capacitors do not contain liquid hazardous materials.

The operating section contains:

Tantalum/Niobium	Graphite/carbon
Tantalum/Niobium oxide	Conducting paint/resins
Manganese dioxide	Fluoropolymers (not TAC)

The encapsulation contains:

TAC - epoxy molding compound, solder/tin coated terminal pads

TAJ, TPS, TPM, TRJ, TRM, TAW, TLJ, TLN, TCJ, TCM, TCN, NLJ, NOJ, NOS and NOM - epoxy molding compound, tin/solder coated terminal pads

THJ - may contain Antimony trioxide and Bromide compounds as fire retardants.

TAP - solder, solder coated terminal wires, epoxy dipped resin

The capacitors do not contain PBB or PBBO/PBBE. The solder alloys may contain lead.

2. Physical Form

These capacitors are physically small and are either rectangular with solderable terminal pads, or cylindrical or bead shaped with solderable terminal wires.

3. Intrinsic Properties

Operating

Both Tantalum and OxiCap® capacitors are polarized devices and operate satisfactorily in the correct d.c. mode. They will withstand a limited application of reverse voltage as stated in the datasheets. However, a reverse application of the rated voltage will result in early short circuit failure and may result in fire or explosion. Consequential failure of other associated components in the circuit e.g. diodes, transformers, etc. may also occur. When operated in the correct polarity, a long period of satisfactory operation will be obtained but failure may occur for any of the following reasons:

- normal failure rate
- surge voltage exceeded
- reverse voltage exceeded
- temperature too high
- ripple rating exceeded

If this failure mode is a short circuit, the previous conditions apply. If the adjacent circuit impedance is low, voltage or current surges may exceed the power handling capability of the capacitor. For this reason capacitors in circuits of below 1Ω/V should be derated by minimum 50% for tantalum and 20% for OxiCap®. Precautions should be taken to prevent reverse voltage spikes. Where capacitors may be subjected to fast switched, low impedance source voltages, the manufacturers advice should be sought to determine the most suitable capacitors for such applications.

Non-operating

Both Tantalum and OxiCap® capacitors contain no liquids or noxious gases to leak out. However, cracking or damage to the encapsulation may lead to premature failure due to ingress of material such as cleaning fluids or to stresses transmitted to the tantalum anode.

4. Fire Characteristics

Primary

Any component subject to abnormal power dissipation may

- self ignite
- become red hot
- break open or explode emitting flaming or red hot material, solid, molten or gaseous.

Fumes from burning components will vary in composition depending on the temperature, and should be considered to be hazardous, although fumes from a single component in a well ventilated area are unlikely to cause problems.

Secondary

Induced ignition may occur from an adjacent burning or red hot component. Epoxy resins used in the manufacture of capacitors give off noxious fumes when burning as stated above. Wherever possible, capacitors comply with the following:

BS EN 60065

UL 492.60A/280

LOI (ASTM D2863-70) as stated in the datasheets.

5. Storage

AVX Tantalum dielectric chip capacitors are unaffected by the following storage condition for 2 years:

Temperature: -10°C – +50°C

Humidity: 75% RH maximum

Atmospheric pressure: 860 mbar ~ 1060mbar

Tantalum and OxiCap® capacitors exhibit a very low random failure rate after long periods of storage and apart from this there are no known modes of failure under normal storage conditions. All capacitors will withstand any environmental conditions within their ratings for the periods given in the detail specifications. Storage for longer periods under high humidity conditions may affect the leakage current of resin protected capacitors. Solderability of solder coated surfaces may be affected by storage of excess of 2 years. If F-series capacitors should be stored more than 1 year please contact AVX for advice.

6. Moisture Sensitivity Level

MSL is defined in J-STD-020. It is applicable to non-hermetic surface mount devices, and is focussed on parts in plastic packages.

The basic concept is that a plastic package may contain moisture, which can become a high pressure vapour during solder reflow. If this occurs, the vapor pressure may cause internal cracking or damage to the device. It can also result in external steam jets from the package, and these may displace other nearby components on the circuit board during the solder process. A common industry reference for this is "popcorning".

AVX solid tantalum and OxiCap® chips which are considered MSL 1 are molded in plastic packages, and are packaged in standard packaging, not including a moisture barrier unless dry pack MSL 3 special option is used (special character V in part number).

AVX solid tantalum and OxiCap® chips which are considered MSL 3 are molded in plastic packages, and are distributed in packaging including a moisture barrier.

Material Data and Handling

AVX solid tantalum TACmicrochips® (TAC, TPC) are considered MSL 1 and supplied in packaging with a moisture barrier. TLC series is considered MSL 3 and is distributed in packaging including a moisture barrier.

7. Disposal

Incineration of epoxy coated capacitors will cause emission of noxious fumes and metal cased capacitors may explode due to build up of internal gas pressure. Disposal by any other means normally involves no special hazards. Large quantities may have salvage value.

8. Unsafe Use

Most failures are of a passive nature and do not represent a safety hazard. A hazard may, however, arise if this failure causes a dangerous malfunction of the equipment in which the capacitor is employed. Circuits should be designed to fail safe under the normal modes of failure. The usual failure mode is an increase in leakage current or short circuit. Other possible modes are decrease of capacitance, increase in dissipation factor (and impedance) or an open-circuit. Operations outside the ratings quoted in the datasheets represents unsafe use.

9. Handling

Careless handling of the cut terminal leads could result in scratches and/or skin punctures. Hands should be washed after handling solder coated terminals before eating or smoking, to avoid ingestion of lead. Capacitors must be kept out of the reach of small children. Care must be taken to discharge capacitors before handling as capacitors may retain a residual charge even after equipment in which they are being used has been switched off. Sparks from the discharge could ignite a flammable vapor.

Environmental Information

AVX has always sought to minimize the environmental impact of its manufacturing operations and of its capacitors supplied to customers throughout the world. We have a policy of preventing and minimizing waste streams during manufacture, and recycling materials wherever possible. We actively avoid or minimize environmentally hazardous materials in our production processes.

1. Material Content

For customers wishing to assess the environmental impact of AVX's capacitors contained in waste electrical and electronic equipment, the following information is provided:

Surface mount tantalum capacitors contain:

- Tantalum/Niobium and Tantalum/Niobium oxide
- Manganese dioxide
- Carbon/graphite
- Silver
- Tin/Tin-lead alloy plating
- Nickel-iron alloy or Copper alloy depending on design (consult factory for details)
- Polymers including fluorinated polymers
- Epoxide resin encapsulant

The encapsulant is made fire retardant to UL 94 V-0 by the inclusion of inert mineral filler and fire retardants.

2. Packaging Material

The component packing tape is recyclable Polycarbonate and the sealing tape is a laminate of halogen-free polymers. The reels are recyclable polystyrene, and marked with the recycling symbol. The reels are over-packed in recyclable fiber board boxes. None of the packing contains heavy metals.

3. Lead (Pb)

Parts supplied today are electroplated over the terminal contact area with 100% fused matte Tin (Sn). Parts with SnPb termination finish are available upon request only. Contact AVX for availability of parts with SnPb termination finish.

4. Fire Retardants

A combustible encapsulant free of antimony trioxide and organic bromide compound are supplied today. AVX believes that the health and safety benefits of using these materials to provide fire retardancy during the life of the product, far outweigh the possible risks to the environment and human health.

5. Nickel Alloy

It is intended that all case sizes will be made with a high copper alloy termination. Some case sizes are supplied now with this termination, and other sizes may be available. Please contact AVX if you prefer this.

6. Recycling

Surface mount Tantalum and OxiCap® capacitors have a very long service life with no known wear-out mechanism, and a low failure rate. However, parts contained in equipment which is of no further use will have some residual value mainly because of the Tantalum metal or niobium oxide contained. This can be recovered and recycled by specialist companies. The silver and nickel or copper alloy will also have some value. Please contact AVX if you require assistance with the disposal of parts. Packaging can be recycled as described above.

7. Disposal

Surface mount Tantalum and OxiCap® capacitors do not contain any liquids and no part of the devices is normally soluble in water at neutral pH values. Incineration will cause the emission of noxious fumes and is not recommended except by specialists. Landfill may be considered for disposal, bearing in mind the small lead content.

Under certain extreme physical conditions it is possible to generate ignition of Tantalum, Niobium and Niobium oxide capacitors. These physical conditions relate to high-speed impact and although not considered to be a normal operating occurrence may occur as a method of material(s) recovery. Therefore appropriate safeguards procedures and methodologies need to be adopted to eliminate any risks of material ignition.

For further information, please contact your local AVX sales office or representative.

8. Typical Weight by Case Sizes

The approximate content of some materials is given in the table below.

The specific weight of other materials contained in the various case sizes is available on written request.

Case Size	TAJ, TPS TRJ, TLJ THJ	TPM TRM	TLN	TCJ	TCM	TCN	TAW	TMJ	NOJ NOS NLJ	NOM	TAC, TLC TPC, TMC	F38	F72	F75	F91 F93 F97	F92	F95	F98	
Typical Weight (mg)																			
A	29			28					25		57.3				28	19	37		
B	68			72					57		83.6				65	36	68		
C	166			137					154					240	160		1		
D	290	298		346			323		265					400	300				
E	512	527		472	474				392	402									
F	148								109										
G	28			25					23										
H	52			51							15.2								
J											5.9								
K	17		22	15							2.8								
L			41			38					9								
M			10								11.3	5.7	330					6	
N	9		10	13		10									350				
P	15			15					12							9	18		
Q																	20		
R	10			10							23.4		180	670			7		
S	19		27	18		25			17			12.4					25	13	
T	35		47	39		43			32		65.8						41		
U	738							708			8.5			160				1.6	
V	641	649		655				681	510		16.4								
W	99			100					82										
X	152								126										
Y	223	237		215					178										
Z											3.9								
4				426															
6				1056															

Environmental Information

9. RoHS Compliance

9.1 Tantalum & Niobium Oxide Capacitors (excluding F-series)

AVX can declare that we do not add any materials from the list below to series TAJ, TPS, TPM, TRJ, TRM, THJ, TAW, TLJ, TLN, TCJ, TCM, TCN, TAC, TLC, TPC, NLJ, NOJ, NOS and NOM during production, so they are not contained in any significant level.

9.2 F-Series Eco-Products “GeoCap”

AVX promotes environmentally conscious practices.

AVX offers “GeoCap”, which has completely lead free terminals and contains no polyvinyl chloride in the sleeve.

Substances		Taping Code	RoHS Compliance
Heavy Metals	Cadmium and cadmium compounds	All	YES
	Lead and lead compounds	A,B,Y,P	YES
		R,S,T,U	YES, since production date 1/1/04
	K,H	NO	
	Mercury and mercury compounds	All	YES
Hexavalent chromium compounds	All	YES	
Chlorinated organic compounds	Polychlorinated biphenyls (PCB)	All	YES
	Polychlorinated naphthalenes (PCN)	All	YES
	Chlorinated paraffins (CP)	All	YES
	Mirex (Perchlordecone)	All	YES
Brominated organic compounds	Polybrominated biphenyls (PBB)	All	YES
	Polybrominated diphenylethers (PBDE)	All	YES

F-SERIES TANTALUM CAPACITORS

Type - Classification		Series	Lead-Free Compliance	Anti Polyvinyl Chloride Compliance
Surface Mount type	Resin-Molded type	F38, F91, F92, F93, F97, F98	Complied	Complied
	Conformal Coated type	AUDIO F95, F95, F72, F75		

F-SERIES TANTALUM CAPACITORS CORRESPONDING TO RoHS DIRECTIVE

		Solid Tantalum Electrolytic Capacitors		
		Resin-Molded Chip F91, F92, F93, F97 series	Frameless Conformal Coated Chip AUDIO F95, F95, F72, F75 series	Frameless Resin-Molded Chip F38, F98 series
Corresponding to RoHS Directive		Complied	Complied	Complied
Material	The portion of the components	Does not contain	Does not contain	Does not contain
	Plating on terminals	Sn	Sn-Cu	Au
Lead (Pb)	Structural component	Does not contain	Does not contain	Does not contain
	Construction of terminal	42 Alloy/ Ni / Sn	Ni / Sn-Cu solder	Cu / Ni / Au
		Plating thickness 5µm Plating type matte No heat treatment after plating	Plating thickness 30µm (Solder dipping) No heat treatment after plating	Au thickness 0.05µm Au type matte No heat treatment after plating
	Solderability Shear strength	No significant solderability difference between Sn-Ag-Cu and Sn-Pb solder.	No significant solderability difference between Sn-Ag-Cu and Sn-Pb solder.	No significant solderability difference between Sn-Ag-Cu and Sn-Pb solder.
Chromium (VI)		Does not contain	Does not contain	Does not contain
Mercury				
Cadmium				
PBB				
PBDE				
MSL (IPC/JEDEC J-STD-020)		LEVEL 1 No need dry package	※ LEVEL 1 to LEVEL 3 If you need detailed information about MSL LEVEL, please contact your local AVX sales office.	※ LEVEL 1 to LEVEL 3 If you need detailed information about MSL LEVEL, please contact your local AVX sales office.

Tantalum & Niobium Oxide Capacitors

(excluding F-series)

Tape & Reel Packaging

Tape and reel packaging for automatic component placement. Please enter required Suffix on order. Bulk packaging is not available.

TAPE SPECIFICATION

Tape dimensions comply to EIA 481-1 Dimensions A₀ and B₀ of the pocket and the tape thickness, K, are dependent on the component size. Tape materials do not affect component solderability during storage. Carrier Tape Thickness <0.4mm.

TAPING SUFFIX TABLE TAJ, TPS, TPM, TRJ, TRM, THJ, TAW, TLJ, TLN TCJ, TCM, TCN, NLJ, NOJ, NOS, NOM

Case Size	Tape width mm	P mm	180mm (7") reel Tin Termination			330mm (13") reel Tin Termination			180mm (7") reel & Gold Termination	
			Suffix	Automotive Suffix	Qty.	Suffix	Automotive Suffix	Qty.	Suffix	Qty.
A	8	4	R	T	2,000	S	U	8,000	A	2,000
B	8	4	R	T	2,000	S	U	8,000	A	2,000
C	12	8	R	T	500	S	U	3,000	A	500
D	12	8	R	T	500	S	U	2,500	A	500
E	12	8	R	T	400	S	U	1,500	A	400
F	12	8	R	-	1,000	S	-	4,000	A	1,000
G	8	4	R	-	2,500	S	-	10,000	A	2,500
H	8	4	R	-	2,500	S	-	10,000	A	2,500
K	8	4	R	-	3,000	S	-	13,000	A	3,000
L	8	4	R	-	2,500	S	-	10,000	A	2,500
M	8	4	R	-	3,000	S	-	13,000	A	3,000
N	8	4	R	-	3,000	S	-	13,000	A	3,000
P	8	4	R	-	2,500	S	-	10,000	A	2,500
R	8	4	R	-	2,500	S	-	10,000	A	2,500
S	8	4	R	-	2,500	S	-	10,000	A	2,500
T	8	4	R	-	2,500	S	-	10,000	A	2,500
U	16	8	R	-	400	-	-	-	-	-
V	12	8	R	-	400	S	-	1,500	A	400
W	12	8	R	-	1,000	S	-	5,000	A	1,000
X	12	8	R	-	1,000	S	-	5,000	A	1,000
Y	12	8	R	-	1,000	S	-	4,000	A	1,000
Z	16	8	R	-	400	S	-	1,500	-	-
4	16	8	R	-	800	S	-	TBD	-	-
6	24	12	R	-	500	S	-	TBD	-	-

Under Development

TAPING SUFFIX TABLE TAC AND TLC

Case Size	Tape width mm	P mm	100mm (4") reel Tin Termination		180mm (7") reel Tin Termination		100mm (4") reel & Gold Termination		180mm (7") reel & 100% Gold Termination	
			Suffix	Qty.	Suffix	Qty.	Suffix	Qty.	Suffix	Qty.
A	8	4	XTA	500	RTA	2,000	FTA	500	ATA	2,000
B	8	4	XTA	500	RTA	2,500	FTA	500	ATA	2,500
C	8	4	XTA	500	RTA	3,500	-	-	-	-
H	8	4	XTA	500	RTA	3,500	FTA	500	ATA	3,500
J	8	4	XTA	500	RTA	3,500	FTA	500	ATA	3,500
K	8	2	QTA	1,000	PTA	10,000	NTA	1,000	MTA	10,000
L	8	4	XTA	500	RTA	3,500	FTA	500	ATA	3,500
M	8	4	XTA	500	RTA	2,500	FTA	500	ATA	2,500
N	8	2	QTA	1,000	PTA	10,000	-	-	-	-
Q	8	4	XTA	500	RTA	2,500	-	-	-	-
R	8	4	XTA	500	RTA	2,500	FTA	500	ATA	2,500
S	8	4	XTA	500	RTA	2,500	-	-	-	-
T	8	4	XTA	500	RTA	2,500	FTA	500	ATA	2,500
U	8	4	XTA	500	RTA	3,500	FTA	500	ATA	3,500
V	8	4	XTA	500	RTA	2,500	FTA	500	ATA	2,500
Z	8	2	QTA	1,000	PTA	10,000	-	-	-	-

Under Development

Tantalum & Niobium Oxide Capacitors

(excluding F-series)

Tape & Reel Packaging

TAPING SUFFIX TABLE TPC

Case Size	Tape width mm	P mm	100mm (4") reel Tin Termination		180mm (7") reel Tin Termination		100mm (4") reel & Gold Termination		180mm (7") reel & 100% Gold Termination	
			Suffix	Qty.	Suffix	Qty.	Suffix	Qty.	Suffix	Qty.
H	8	4	Xxxxx	500	Rxxxx	3,500	Fxxxx	500	Axxxx	3,500
K	8	2	Qxxxx	1,000	Pxxxx	10,000	Nxxxx	1,000	Mxxxx	10,000
L	8	4	Xxxxx	500	Rxxxx	3,500	Fxxxx	500	Axxxx	3,500
R	8	4	Xxxxx	500	Rxxxx	2,500	Fxxxx	500	Axxxx	2,500

Note: xxxx = ESR value in Milliohms

TAPING SUFFIX TABLE TLC

Case Size	Tape width mm	P mm	100mm (4") reel Tin Termination		180mm (7") reel Tin Termination		100mm (4") reel & Gold Termination		180mm (7") reel & 100% Gold Termination	
			Suffix	Qty.	Suffix	Qty.	Suffix	Qty.	Suffix	Qty.
L	8	4	Xxxxx	500	Rxxxx	3,500	Fxxxx	500	Axxxx	3,500

Note: xxxx = ESR value in Milliohms

Tantalum & Niobium Oxide Capacitors

(excluding F-series)

Tape & Reel Packaging

PLASTIC TAPE DIMENSIONS TAJ, TPS, TPM, TRJ, TRM, THJ, TAW, TLJ, TLN, TCJ, TCM, TCN, NLJ, NOJ, NOS AND NOM

Case	A0±0.10	B0±0.10	K±0.10	W±0.30	E±0.10	F±0.05	G min.	P±0.10	P2±0.05	P0±0.10	D0 ^{+0.20} _{-0.00}	D1 ^{+0.25} _{-0.00}
A	1.83	3.57	1.87	8.00	1.75	3.50	0.75	4.00	2.00	4.00	1.50	1.00
B	3.15	3.77	2.22	8.00	1.75	3.50	0.75	4.00	2.00	4.00	1.50	1.00
C	3.45	6.40	2.92	12.00	1.75	5.50	0.75	8.00	2.00	4.00	1.50	1.50
D	4.48	7.62	3.22	12.00	1.75	5.50	0.75	8.00	2.00	4.00	1.50	1.50
E	4.50	7.50	4.50	12.00	1.75	5.50	0.75	8.00	2.00	4.00	1.50	1.50
F	3.35	6.40	2.20	12.00	1.75	5.50	0.75	8.00	2.00	4.00	1.50	1.50
G	1.83	3.57	1.65	8.00	1.75	3.50	0.75	4.00	2.00	4.00	1.50	1.00
H	3.15	3.77	1.66	8.00	1.75	3.50	0.75	4.00	2.00	4.00	1.50	1.00
K	1.95	3.55	1.15	8.00	1.75	3.50	0.75	4.00	2.00	4.00	1.50	1.00
L	3.10	3.80	1.30	8.00	1.75	3.50	0.75	4.00	2.00	4.00	1.50	1.00
M	1.60	2.35	1.10	8.00	1.75	3.50	0.75	4.00	2.00	4.00	1.50	1.00
N	1.60	2.30	1.10	8.00	1.75	3.50	0.75	4.00	2.00	4.00	1.50	1.00
P	1.65	2.45	1.60	8.00	1.75	3.50	0.75	4.00	2.00	4.00	1.50	1.00
R	1.65	2.45	1.30	8.00	1.75	3.50	0.75	4.00	2.00	4.00	1.50	1.00
S	1.95	3.55	1.30	8.00	1.75	3.50	0.75	4.00	2.00	4.00	1.50	1.00
T	3.20	3.80	1.30	8.00	1.75	3.50	0.75	4.00	2.00	4.00	1.50	1.00
U	6.19	7.66	4.72	16.00	1.75	7.50	0.75	8.00	2.00	4.00	1.50	1.50
V	6.43	7.44	3.84	12.00	1.75	5.50	0.75	8.00	2.00	4.00	1.50	1.50
W	3.57	6.40	1.65	12.00	1.75	5.50	0.75	8.00	2.00	4.00	1.50	1.50
X	4.67	7.62	1.65	12.00	1.75	5.50	0.75	8.00	2.00	4.00	1.50	1.50
Y	4.67	7.62	2.15	12.00	1.75	5.50	0.75	8.00	2.00	4.00	1.50	1.50
4	6.25	7.88	2.25	16.00	1.75	7.50±0.1	0.75	8.00	2.00±0.1	4.00	1.50	1.50
6	8.55	15.60	2.25	24.00	1.75	11.50	0.75	12.00	2.00	4.00	1.50	1.50

PLASTIC TAPE DIMENSIONS TAC, TLC AND TPC

Case	A0±0.10	B0±0.10	K±0.10	W±0.30	E±0.10	F±0.05	G min.	P±0.10	P2±0.05	P0±0.10	D0 ^{+0.20} _{-0.00}	D1 ^{+0.20} _{-0.00}
A	1.83±0.10	3.57±0.10	1.87±0.10	8.00	1.75	3.50	0.75	4.00	2.00	4.00	1.50	1.00
B	3.15±0.10	3.77±0.10	1.66±0.10	8.00	1.75	3.50	0.75	4.00	2.00	4.00	1.50	1.00
C	1.95±0.10	3.55±0.10	1.15±0.10	8.00	1.75	3.50	0.75	4.00	2.00	4.00	1.50	1.00
H	1.65±0.10	2.45±0.10	1.10±0.05	8.00	1.75	3.50	0.75	4.00	2.00	4.00	1.50	1.00
J	1.05 ^{+0.10} _{-0.00}	1.90 ^{+0.10} _{-0.00}	0.80 ^{+0.10} _{-0.00}	8.00	1.75	3.50	0.75	4.00	2.00	4.00	1.50	0.80
K	0.75 ^{+0.05} _{-0.00}	1.26 ^{+0.10} _{-0.00}	0.67 ^{+0.10} _{-0.00}	8.00	1.75	3.50	0.75	2.00	2.00	2.00	1.50	0.50
L	1.05 ^{+0.10} _{-0.00}	1.90 ^{+0.10} _{-0.00}	1.05 ^{+0.10} _{-0.00}	8.00	1.75	3.50	0.75	4.00	2.00	4.00	1.50	0.80
M	1.05 ^{+0.10} _{-0.00}	2.45±0.10	1.05 ^{+0.10} _{-0.00}	8.00	1.75	3.50	0.75	4.00	2.00	4.00	1.50	0.80
Q	1.65±0.10	2.45±0.10	1.30±0.10	8.00	1.75	3.50	0.75	4.00	2.00	4.00	1.50	1.00
R	1.65±0.10	2.45±0.10	1.60±0.10	8.00	1.75	3.50	0.75	4.00	2.00	4.00	1.50	1.00
S	1.95±0.10	3.55±0.10	1.30±0.10	8.00	1.75	3.50	0.75	4.00	2.00	4.00	1.50	1.00
T	3.20±0.10	3.80±0.10	1.30±0.10	8.00	1.75	3.50	0.75	4.00	2.00	4.00	1.50	1.00
U	1.65±0.10	2.45±0.10	0.80±0.05	8.00	1.75	3.50	0.75	4.00	2.00	4.00	1.50	1.00
V	1.95±0.10	3.60±0.10	0.90±0.10	8.00	1.75	3.50	0.75	4.00	2.00	4.00	1.50	1.00
X	1.83±0.10	3.57±0.10	1.87±0.10	8.00	1.75	3.50	0.75	4.00	2.00	4.00	1.50	1.00
Z	0.75 ^{+0.05} _{-0.00}	1.90 ^{+0.10} _{-0.00}	0.67 ^{+0.10} _{-0.00}	8.00	1.75	3.50	0.75	2.00	2.00	2.00	1.50	0.50

Under development

Tantalum & Niobium Oxide Capacitors **AVX** (excluding F-series)

Tape & Reel Packaging

REEL DIMENSIONS

Reel Size	Tape	A	B	C	W	t
180mm (7")	12mm	178±2.00	50 min	13.0±0.50	12.4+1.5/-0	1.50±0.50
180mm (7")	8mm	178±2.00	50 min	13.0±0.50	8.4+1.5/-0	1.50±0.50
330mm (13")	12mm	328±2.00	50 min	13.0±0.50	12.4+1.5/-0	1.50±0.50
330mm (13")	8mm	328±2.00	50 min	13.0±0.50	8.4+1.5/-0	1.50±0.50
108mm (4.25")	8mm	108±2.00		13.0±0.50	8.4+1.5/-0	1.50±0.50

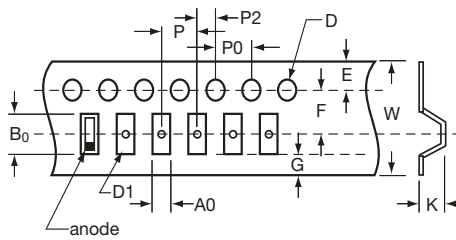
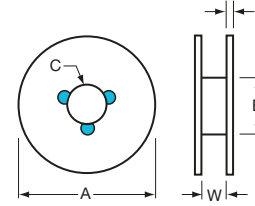

COVER TAPE NOMINAL DIMENSIONS

Thickness: 75µm
 Width of tape: 5.5mm (8mm tape)
 9.5mm (12mm tape)

F-Series Tantalum Capacitors



Tape & Reel Packaging

TAPING QUANTITY TABLE – F-SERIES CAPACITORS

Series	Case Size	180mm (7") Reel	330mm (13") Reel
		Tin Termination Qty.	Tin Termination Qty.
F38, F98	U	10,000	–
	M, S	4,000	–
F92	P	3,000	8,000
	A, B	2,500	8,000
F91	A	2,000	8,000
F93	B	2,000	6,000
F97	C, N	500	2,500
F95 AUDIO F95	R, P	3,000	10,000
	Q, S, A, T	2,500	10,000
	B	2,000	8,500
F72	R	1,000	–
	M	500	–
F75	U, C, D, R	500	–

(*) : Export packaging. There are some differences between actual minimum quantity and above list. Please confirm before you order.

TYPE NUMBERING SYSTEM

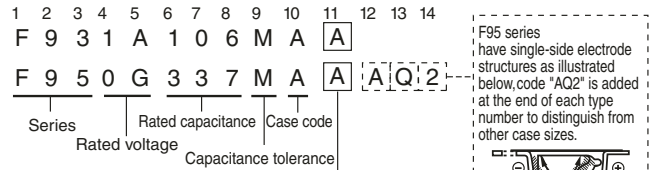

Tape Width (mm)	Polarity	Tape		Applicable Case Size		
		Reel Dia ϕ 180 mm	Reel Dia ϕ 330 mm	F91, F92 F93, F97 F98	F95 AUDIO F95	F72 F75
8	R (Anode is at opposite side of feeding holes)	A	E	U, M, S P, A, B	R, P, Q S, A, T B	–
12	R (Anode is at opposite side of feeding holes)	C	G	C, N	–	U, C D, R M

REEL DIMENSIONS (mm)

Item	Reel Diameter	
	180 ϕ	330 ϕ
A	ϕ 180 $^{+0}_{-3}$	ϕ 330 \pm 2

Item	Tape Width	
	8	12
W ₁	9.0 \pm 0.3	13 \pm 0.3
W ₂	11.4 \pm 1.0	15.4 \pm 1.0

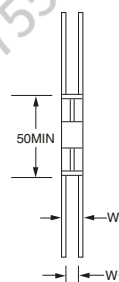
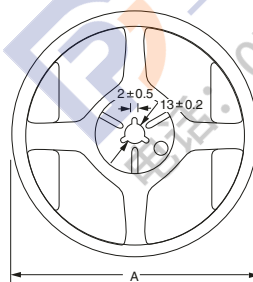

Note: The above shows the dimensions of ϕ 180 reel. In case of ϕ 330 reel, the appearance shape is slightly different.

CARRIER TAPE DIMENSIONS (mm)

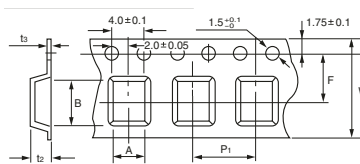

F91, F92, F93, F97, F98 M, F38 M

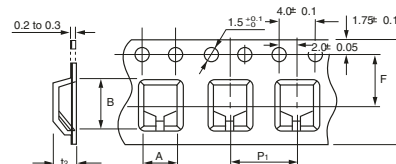

F95, AUDIO F95, F72, F75

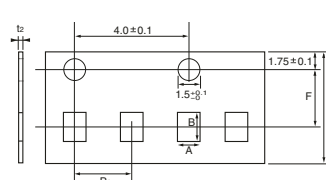

F98U

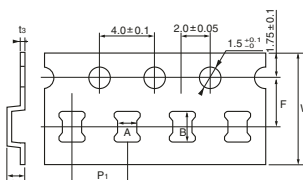

F98 S, F38 S

Case Code	W	A	B	F	P ₁	t ₂	t ₃
U	8.0 \pm 0.3	0.73 \pm 0.08	1.20 \pm 0.05	3.5 \pm 0.05	2.0 \pm 0.1	0.7 Max.	–
M		0.97 \pm 0.05	1.85 \pm 0.05			0.95 \pm 0.05	0.20 \pm 0.05
S		1.35 \pm 0.1	2.15 \pm 0.1	4.0 \pm 0.1		1.4 Max.	0.2 to 0.3
P		1.55 \pm 0.1	2.3 \pm 0.1			(1.7 Max.)	
A		1.9 \pm 0.1	3.5 \pm 0.1			2.1 Max. (1.7)	
B	3.3 \pm 0.1	3.8 \pm 0.1	3.5 \pm 0.05	2.4 Max. (1.7)			
C	12.0 \pm 0.3	3.6 \pm 0.1	6.3 \pm 0.1	5.5 \pm 0.05	8.0 \pm 0.1	2.9 Max.	
N		4.8 \pm 0.1	7.7 \pm 0.1			3.5 Max.	3.9 Max.

Type	Case Code	W	A	B	F	P ₁	t ₂		
F95 AUDIO F95	R	8.0 \pm 0.3	1.4 \pm 0.2	2.6 \pm 0.2	3.5 \pm 0.05	4.0 \pm 0.1	1.05 Max.		
	P			1.5 Max.					
	Q, S			2.0 \pm 0.2			3.6 \pm 0.2	1.5 Max.	
	A			2.1 \pm 0.2			3.7 \pm 0.2	2.0 Max.	
	T			3.0 \pm 0.2			3.6 \pm 0.2	1.5 Max.	
	B			3.1 \pm 0.2			3.7 \pm 0.2	2.4 Max.	
F72	R	12.0 \pm 0.3	6.5 \pm 0.2	7.6 \pm 0.2	5.5 \pm 0.1	8.0 \pm 0.1	2.2 Max.		
	M						2.5 Max.		
F75	U	12.0 \pm 0.3	3.7 \pm 0.2	7.6 \pm 0.2	5.5 \pm 0.1	8.0 \pm 0.1	2.7 Max.		
	C						3.6 Max.		
	D						4.8 \pm 0.2	7.9 \pm 0.2	3.9 Max.
	R						6.5 \pm 0.2	7.6 \pm 0.2	4.6 Max.



Tantalum & Niobium Oxide Capacitors **AVX**

Marking

For TAJ, TPS & THJ, the positive end of body has videcon readable polarity marking as shown in the diagram. Bodies are marked by indelible laser marking on top surface with capacitance value, voltage and ID code. N, P and R case is an exception due to small size in which only the voltage and capacitance values are printed.

All series excluding F-Series capacitors

Voltage Code	Rated Voltage at 85°C	Voltage Code	Rated Voltage at 85°C
X	1.8	D	20
E	2.5	E	25
G	4	V	35
J	6.3	T	50
P	8	J	63
A	10	P	75
B	12	A	100
C	16	B	125

TAJ, TRJ, TRM, TPS, TPM – A, B, C, D, E, F, H, K, S, T, U, V, W, X AND Y CASE:

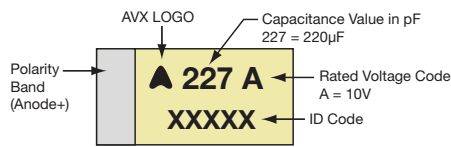

TCJ, TCM, TCN – A, B, C, D, E, G, H, K, L, S, T, V, W, Y CASE:

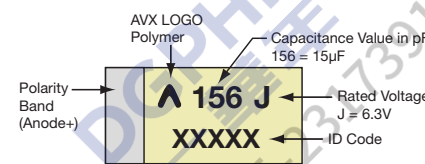

TLJ, TLN – A, B, F, G, H, K, L, S, T, V, W, Y CASE:

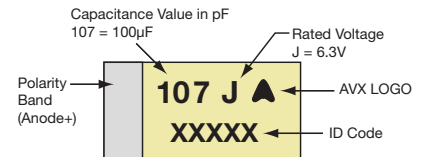

TAJ, TPS – P AND R CASE:

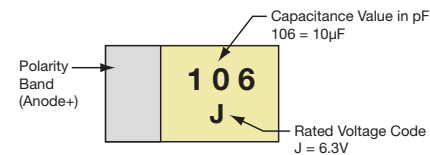

TCJ – N, P, R CASE:

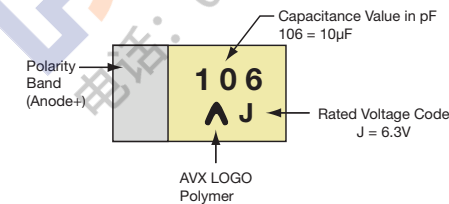

TLJ, TLN – M, N, P, R CASE:

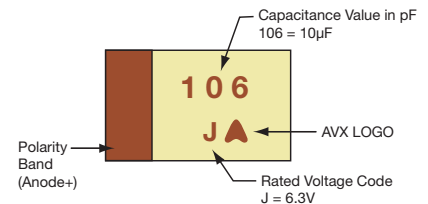

THJ – A, B, C, D, E CASE:

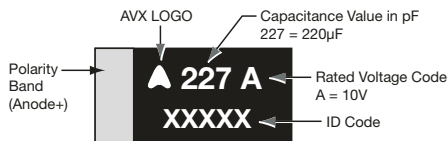

TAW – D CASE:

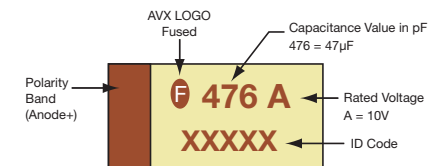

TLN PULSECAP™ 4 AND 6 CASE:

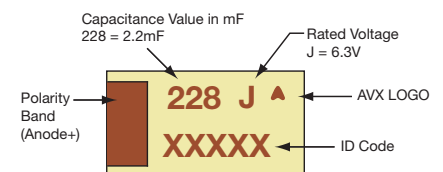

NOJ, NOS, NOM – A, B, C, D, E, F, S, T, V, W, X, Y CASE:

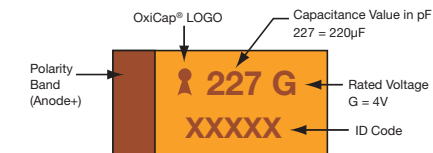

NLJ – A, B, G, P, S, T, CASE:

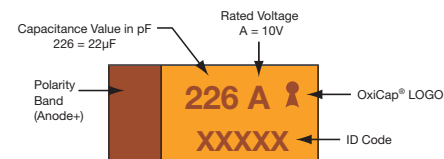

TAC, TLC, TPC – ALL CASE SIZES:

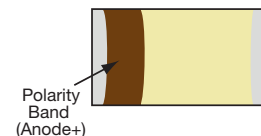

NOJ – P CASE:

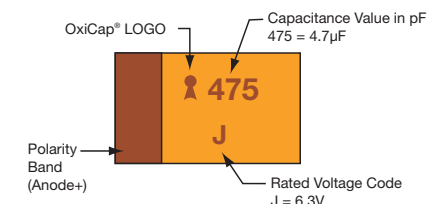

**F-SERIES CAPACITORS
PLEASE REFER TO THE CATALOGUE SHEET**

TAP/TEP Technical Summary and Application Guidelines



SECTION 1: ELECTRICAL CHARACTERISTICS AND EXPLANATION OF TERMS

1.1 CAPACITANCE

1.1.1 Rated capacitance (C_R)

This is the nominal rated capacitance. For tantalum capacitors it is measured as the capacitance of the equivalent series circuit at 20°C in a measuring bridge supplied by a 120 Hz source free of harmonics with 2.2V DC bias max.

1.1.2 Temperature dependence on the capacitance

The capacitance of a tantalum capacitor varies with temperature. This variation itself is dependent to a small extent on the rated voltage and capacitor size. See graph below for typical capacitance changes with temperature.

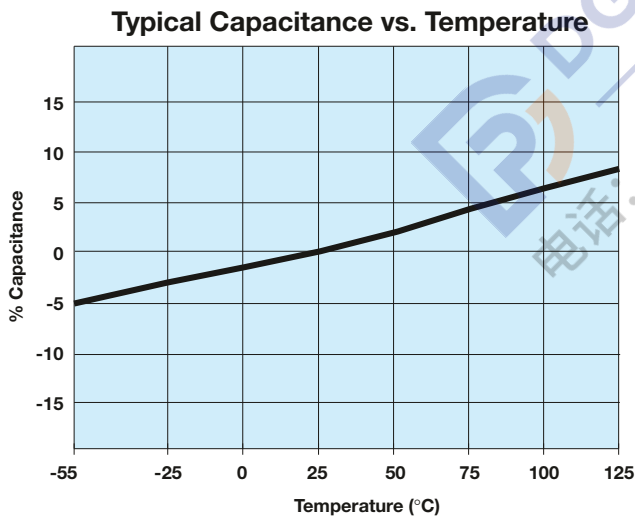

1.1.3 Capacitance tolerance

This is the permissible variation of the actual value of the capacitance from the rated value.

1.1.4 Frequency dependence of the capacitance

The effective capacitance decreases as frequency increases. Beyond 100 kHz the capacitance continues to drop until resonance is reached (typically between 0.5-5 MHz depending on the rating). Beyond this the device becomes inductive.

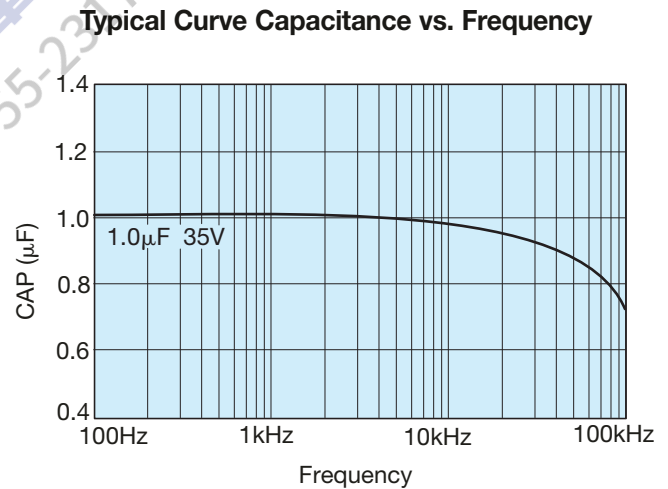

1.2 VOLTAGE

1.2.1 Rated DC voltage (V_R)

This is the rated DC voltage for continuous operation up to +85°C.

1.2.2 Category voltage (V_C)

This is the maximum voltage that may be applied continuously to a capacitor. It is equal to the rated voltage up to +85°C, beyond which it is subject to a linear derating, to 2/3 V_R at 125°C.

1.2.3 Surge voltage (V_S)

This is the highest voltage that may be applied to a capacitor for short periods of time. The surge voltage may be applied up to 10 times in an hour for periods of up to 30 seconds at a time. The surge voltage must not be used as a parameter in the design of circuits in which, in the normal course of operation, the capacitor is periodically charged and discharged.

Category Voltage vs. Temperature

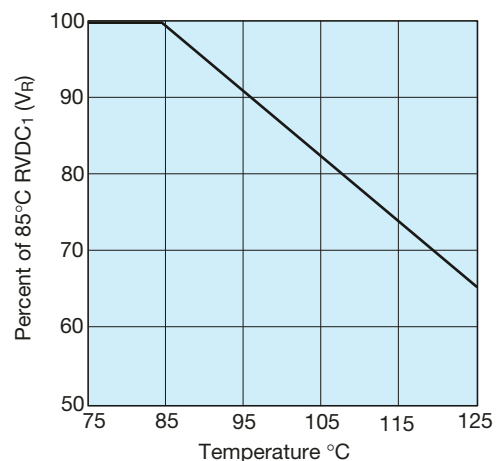

TAP/TEP Technical Summary and Application Guidelines



85°C		125°C	
Rated Voltage (V DC)	Surge Voltage (V DC)	Category Voltage (V DC)	Surge Voltage (V DC)
2	2.6	1.3	1.7
3	4	2	2.6
4	5.2	2.6	3.4
6.3	8	4	5
10	13	6.3	9
16	20	10	12
20	26	13	16
25	33	16	21
35	46	23	28
50	65	33	40

1.2.4 Effect of surges

The solid Tantalum capacitor has a limited ability to withstand surges (15% to 30% of rated voltage). This is in common with all other electrolytic capacitors and is due to the fact that they operate under very high electrical stress within the oxide layer. In the case of 'solid' electrolytic capacitors this is further complicated by the limited self healing ability of the manganese dioxide semiconductor.

It is important to ensure that the voltage across the terminals of the capacitor does not exceed the surge voltage rating at any time. This is particularly so in low impedance circuits where the capacitor is likely to be subjected to the full impact of surges, especially in low inductance applications. Even an extremely short duration spike is likely to cause damage. In such situations it will be necessary to use a higher voltage rating.

1.2.5 Reverse voltage and non-polar operation

The reverse voltage ratings are designed to cover exceptional conditions of small level excursions into incorrect polarity. The values quoted are not intended to cover continuous reverse operation.

The peak reverse voltage applied to the capacitor must not exceed:

10% of rated DC working voltage to a maximum of 1V at 25°C

3% of rated DC working voltage to a maximum of 0.5V at 85°C

1% of category DC working voltage to a maximum of 0.1V at 125°C

1.2.6 Non-polar operation

If the higher reverse voltages are essential, then two capacitors, each of twice the required capacitance and of equal tolerance and rated voltage, should be connected in a back-to-back configuration, i.e., both anodes or both cathodes joined together. This is necessary in order to avoid a reduction in life expectancy.

1.2.7 Superimposed AC voltage (V_{rms}) - Ripple Voltage

This is the maximum RMS alternating voltage, superimposed on a DC voltage, that may be applied to a capacitor. The sum of the DC voltage and the surge value of the superimposed AC voltage must not exceed the category voltage, V_c . Full details are given in Section 2.

1.2.8 Voltage derating

Refer to section 3.2 (pages 157-159) for the effect of voltage derating on reliability.

1.3 DISSIPATION FACTOR AND TANGENT OF LOSS ANGLE (TAN δ)

1.3.1 Dissipation factor (DF)

Dissipation factor is the measurement of the tangent of the loss angle ($\tan \delta$) expressed as a percentage.

The measurement of DF is carried out at +25°C and 120 Hz with 2.2V DC bias max. with an AC voltage free of harmonics. The value of DF is temperature and frequency dependent.

1.3.2 Tangent of loss angle ($\tan \delta$)

This is a measure of the energy loss in the capacitor. It is expressed as $\tan \delta$ and is the power loss of the capacitor divided by its reactive power at a sinusoidal voltage of specified frequency. (Terms also used are power factor, loss factor and dielectric loss, $\cos(90 - \delta)$ is the true power factor.) The measurement of $\tan \delta$ is carried out at +20°C and 120 Hz with 2.2V DC bias max. with an AC voltage free of harmonics.

1.3.3 Frequency dependence of dissipation factor

Dissipation Factor increases with frequency as shown in the typical curves below.

Typical Curve-Dissipation Factor vs. Frequency

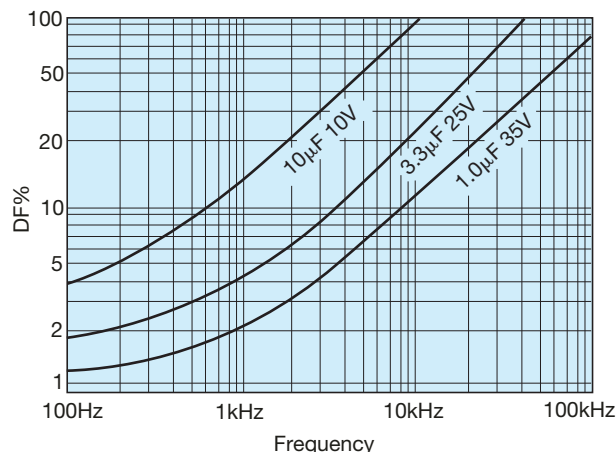

TAP/TEP Technical Summary and Application Guidelines



1.3.4 Temperature dependence of dissipation factor

Dissipation factor varies with temperature as the typical curves show to the right. For maximum limits please refer to ratings tables.

Typical Curves-Dissipation Factor vs. Temperature

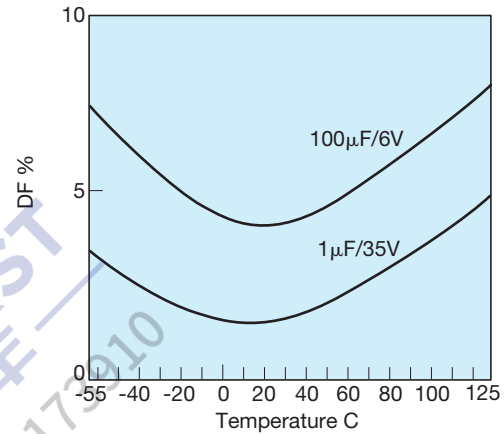

1.4 IMPEDANCE, (Z) AND EQUIVALENT SERIES RESISTANCE (ESR)

1.4.1 Impedance, Z

This is the ratio of voltage to current at a specified frequency. Three factors contribute to the impedance of a tantalum capacitor; the resistance of the semiconducting layer, the capacitance, and the inductance of the electrodes and leads.

At high frequencies the inductance of the leads becomes a limiting factor. The temperature and frequency behavior of these three factors of impedance determine the behavior of the impedance Z. The impedance is measured at 25°C and 100 kHz.

1.4.2 Equivalent series resistance, ESR

Resistance losses occur in all practical forms of capacitors. These are made up from several different mechanisms, including resistance in components and contacts, viscous forces within the dielectric, and defects producing bypass current paths. To express the effect of these losses they are considered as the ESR of the capacitor. The ESR is frequency dependent. The ESR can be found by using the relationship:

$$ESR = \frac{\tan \delta}{2\pi f C}$$

where f is the frequency in Hz, and C is the capacitance in farads. The ESR is measured at 25°C and 100 kHz.

ESR is one of the contributing factors to impedance, and at high frequencies (100 kHz and above) is the dominant factor, so that ESR and impedance become almost identical, impedance being marginally higher.

1.4.3 Frequency dependence of impedance and ESR

ESR and impedance both increase with decreasing frequency. At lower frequencies the values diverge as the extra contributions to impedance (resistance of the semiconducting layer, etc.) become more significant. Beyond 1 MHz (and beyond the resonant point of the capacitor) impedance again increases due to induction.

Frequency Dependence of Impedance and ESR

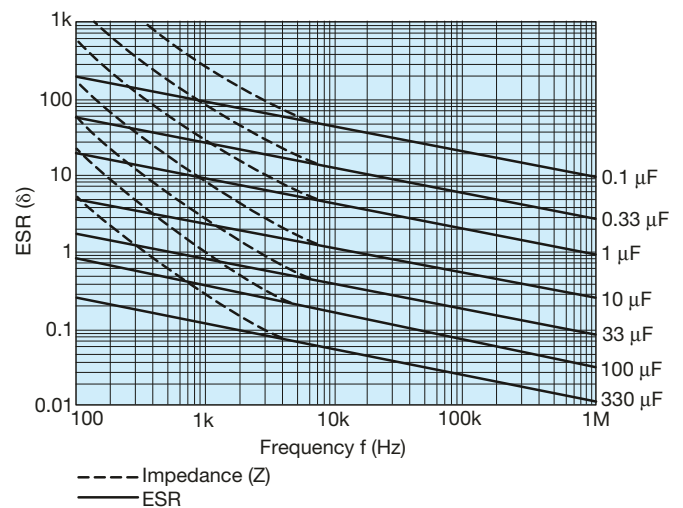

TAP/TEP Technical Summary and Application Guidelines



1.4.4 Temperature dependence of the impedance and ESR

At 100 kHz, impedance and ESR behave identically and decrease with increasing temperature as the typical curves show. For maximum limits at high and low temperatures, please refer to graph opposite.

Temperature Dependence of the Impedance and ESR

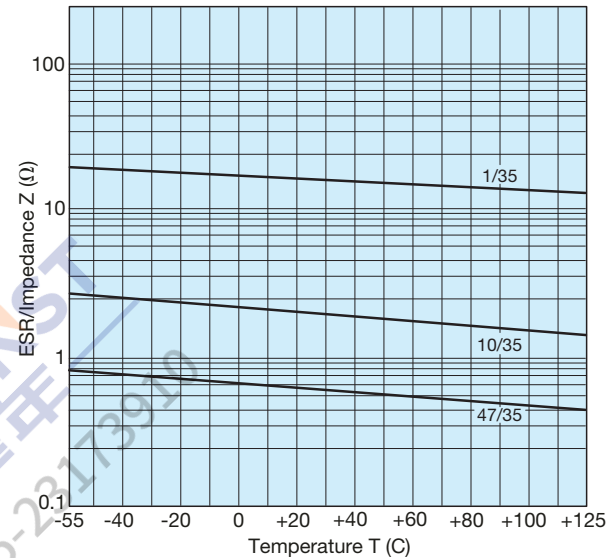

1.5 DC LEAKAGE CURRENT (DCL)

1.5.1 Leakage current (DCL)

The leakage current is dependent on the voltage applied, the time, and the capacitor temperature. It is measured at +25°C with the rated voltage applied. A protective resistance of 1000Ω is connected in series with the capacitor in the measuring circuit.

Three minutes after application of the rated voltage the leakage current must not exceed the maximum values indicated in the ratings table. Reforming is unnecessary even after prolonged periods without the application of voltage.

1.5.2 Temperature dependence of the leakage current

The leakage current increases with higher temperatures, typical values are shown in the graph.

For operation between 85°C and 125°C, the maximum working voltage must be derated and can be found from the following formula.

$$V_{\max} = \left(1 - \frac{T-85}{120}\right) \times V_R \text{ volts}$$

where T is the required operating temperature. Maximum limits are given in rating tables.

1.5.3 Voltage dependence of the leakage current

The leakage current drops rapidly below the value corresponding to the rated voltage V_R when reduced voltages are applied. The effect of voltage derating on the leakage current is shown in the graph.

This will also give a significant increase in reliability for any application. See Section 3 (pages 157-159) for details.

1.5.4 Ripple current

The maximum ripple current allowance can be calculated from the power dissipation limits for a given temperature rise above ambient. Please refer to Section 2 (page 156) for details.

Temperature Dependence of the Leakage Current for a Typical Component

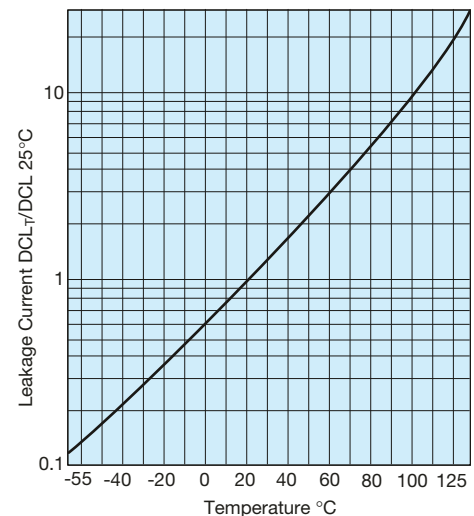

Effect of Voltage Derating on Leakage Current

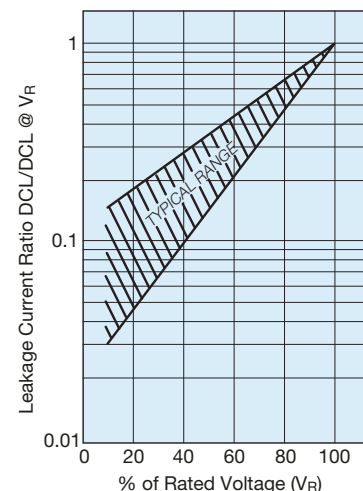

TAP/TEP Technical Summary and Application Guidelines



SECTION 2: AC OPERATION — RIPPLE VOLTAGE AND RIPPLE CURRENT

2.1 RIPPLE RATINGS (AC)

In an AC application heat is generated within the capacitor by both the AC component of the signal (which will depend upon signal form, amplitude and frequency), and by the DC leakage. For practical purposes the second factor is insignificant. The actual power dissipated in the capacitor is calculated using the formula:

$$P = I^2 R = \frac{E^2 R}{Z^2}$$

- I = rms ripple current, amperes
- R = equivalent series resistance, ohms
- E = rms ripple voltage, volts
- P = power dissipated, watts
- Z = impedance, ohms, at frequency under consideration

Using this formula it is possible to calculate the maximum AC ripple current and voltage permissible for a particular application.

2.2 MAXIMUM AC RIPPLE VOLTAGE (E_{MAX})

From the previous equation:

$$E_{(max)} = Z \sqrt{\frac{P_{max}}{R}}$$

where P_{max} is the maximum permissible ripple voltage as listed for the product under consideration (see table).

However, care must be taken to ensure that:

1. The DC working voltage of the capacitor must not be exceeded by the sum of the positive peak of the applied AC voltage and the DC bias voltage.
2. The sum of the applied DC bias voltage and the negative peak of the AC voltage must not allow a voltage reversal in excess of that defined in the sector, 'Reverse Voltage'.

2.3 MAXIMUM PERMISSIBLE POWER DISSIPATION (WATTS) @ 25°C

The maximum power dissipation at 25°C has been calculated for the various series and are shown in Section 2.4, together with temperature derating factors up to 125°C.

For leaded components the values are calculated for parts supported in air by their leads (free space dissipation).

The ripple ratings are set by defining the maximum temperature rise to be allowed under worst case conditions, i.e., with resistive losses at their maximum limit. This differential is normally 10°C at room temperature dropping to 2°C at 125°C. In application circuit layout, thermal management, available ventilation, and signal waveform may significantly

affect the values quoted below. It is recommended that temperature measurements are made on devices during operating conditions to ensure that the temperature differential between the device and the ambient temperature is less than 10°C up to 85°C and less than 2°C between 85°C and 125°C. Derating factors for temperatures above 25°C are also shown below. The maximum permissible proven dissipation should be multiplied by the appropriate derating factor.

For certain applications, e.g., power supply filtering, it may be desirable to obtain a screened level of ESR to enable higher ripple currents to be handled. Please contact our applications desk for information.

2.4 POWER DISSIPATION RATINGS (IN FREE AIR)

TAR – Molded Axial

Case size	Max. power dissipation (W)	Temperature derating factors	
		Temp. °C	Factor
Q	0.065	+25	1.0
R	0.075	+85	0.6
S	0.09	+125	0.4
W	0.105		

TAA – Hermetically Sealed Axial

Case size	Max. power dissipation (W)	Temperature derating factors	
		Temp. °C	Factor
A	0.09	+20	1.0
B	0.10	+85	0.9
C	0.125	+125	0.4
D	0.18		

TAP/TEP – Resin Dipped Radial

Case size	Max. power dissipation (W)	Temperature derating factors	
		Temp. °C	Factor
A	0.045	+25	1.0
B	0.05	+85	0.4
C	0.055	+125	0.09
D	0.06		
E	0.065		
F	0.075		
G	0.08		
H	0.085		
J	0.09		
K	0.1		
L	0.11		
M/N	0.12		
P	0.13		
R	0.14		



TAP/TEP Technical Summary and Application Guidelines



SECTION 3: RELIABILITY AND CALCULATION OF FAILURE RATE

3.1 STEADY-STATE

Tantalum Dielectric has essentially no wear out mechanism and in certain circumstances is capable of limited self healing, random failures can occur in operation. The failure rate of Tantalum capacitors will decrease with time and not increase as with other electrolytic capacitors and other electronic components.

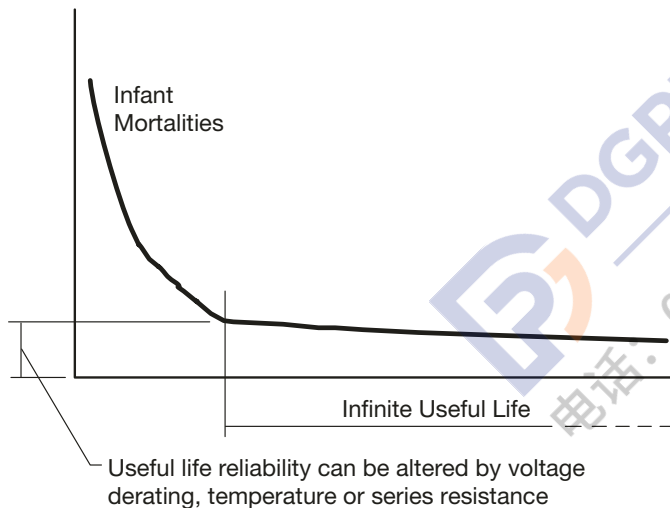

Figure 1. Tantalum reliability curve.

The useful life reliability of the Tantalum capacitor is affected by three factors. The equation from which the failure rate can be calculated is:

$$F = F_U \times F_T \times F_R \times F_B$$

where F_U is a correction factor due to operating voltage/voltage derating

F_T is a correction factor due to operating temperature

F_R is a correction factor due to circuit series resistance

F_B is the basic failure rate level. For standard leaded Tantalum product this is 1%/1000hours

Operating voltage/voltage derating

If a capacitor with a higher voltage rating than the maximum line voltage is used, then the operating reliability will be improved. This is known as voltage derating. The graph, Figure 2, shows the relationship between voltage derating (the ratio between applied and rated voltage) and the failure rate. The graph gives the correction factor F_U for any operating voltage.

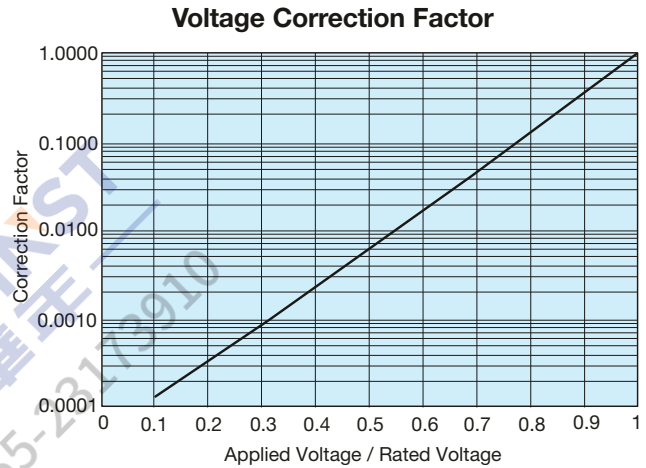

Figure 2. Correction factor to failure rate F for voltage derating of a typical component (60% con. level).

Operating temperature

If the operating temperature is below the rated temperature for the capacitor then the operating reliability will be improved as shown in Figure 3. This graph gives a correction factor F_T for any temperature of operation.

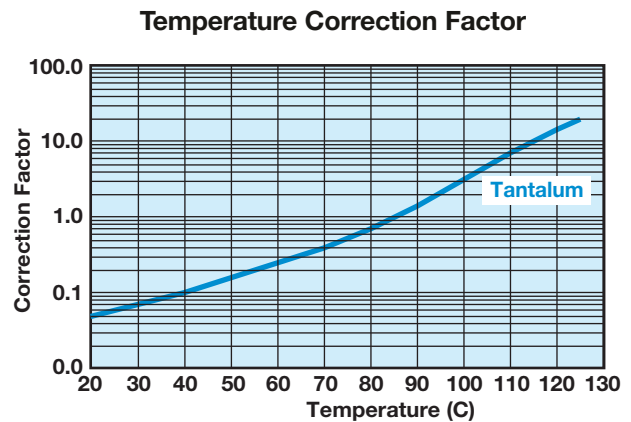

Figure 3. Correction factor to failure rate F for ambient temperature T for typical component (60% con. level).

TAP/TEP Technical Summary and Application Guidelines



Circuit Impedance

All solid tantalum capacitors require current limiting resistance to protect the dielectric from surges. A series resistor is recommended for this purpose. A lower circuit impedance may cause an increase in failure rate, especially at temperatures higher than 20°C. An inductive low impedance circuit may apply voltage surges to the capacitor and similarly a non-inductive circuit may apply current surges to the capacitor, causing localized over-heating and failure. The recommended impedance is 1Ω per volt. Where this is not feasible, equivalent voltage derating should be used (See MIL HANDBOOK 217E). Table I shows the correction factor, F_R , for increasing series resistance.

Table I: Circuit Impedance

Correction factor to failure rate F for series resistance R on basic failure rate F_B for a typical component (60% con. level).

Circuit Resistance ohms/volt	FR
3.0	0.07
2.0	0.1
1.0	0.2
0.8	0.3
0.6	0.4
0.4	0.6
0.2	0.8
0.1	1.0

Example calculation

Consider a 12 volt power line. The designer needs about 10μF of capacitance to act as a decoupling capacitor near a video bandwidth amplifier. Thus the circuit impedance will be limited only by the output impedance of the boards power unit and the track resistance. Let us assume it to be about 2 Ohms minimum, i.e., 0.167 Ohms/Volt. The operating temperature range is -25°C to +85°C. If a 10μF 16 Volt capacitor was designed-in, the operating failure rate would be as follows:

- a) $F_T = 0.8 @ 85^\circ\text{C}$
- b) $F_R = 0.7 @ 0.167 \text{ Ohms/Volt}$
- c) $F_U = 0.17 @ \text{applied voltage/rated voltage} = 75\%$

Thus $F_B = 0.8 \times 0.7 \times 0.17 \times 1 = 0.0952\%/1000 \text{ Hours}$

If the capacitor was changed for a 20 volt capacitor, the operating failure rate will change as shown.

$F_U = 0.05 @ \text{applied voltage/rated voltage} = 60\%$

$F_B = 0.8 \times 0.7 \times 0.05 \times 1 = 0.028\%/1000 \text{ Hours}$

3.2 DYNAMIC

As stated in Section 1.2.4 (page 153), the solid Tantalum capacitor has a limited ability to withstand voltage and current surges. Such current surges can cause a capacitor to fail. The expected failure rate cannot be calculated by a simple formula as in the case of steady-state reliability. The two parameters under the control of the circuit design engineer known to reduce the incidence of failures are derating and series resistance. The table below summarizes the results of trials carried out at AVX with a piece of equipment which has very low series resistance and applied no derating. So that the capacitor was tested at its rated voltage.

Results of production scale derating experiment

Capacitance and Voltage	Number of units tested	50% derating applied	No derating applied
47μF 16V	1,547,587	0.03%	1.1%
100μF 10V	632,876	0.01%	0.5%
22μF 25V	2,256,258	0.05%	0.3%

As can clearly be seen from the results of this experiment, the more derating applied by the user, the less likely the probability of a surge failure occurring.

It must be remembered that these results were derived from a highly accelerated surge test machine, and failure rates in the low ppm are more likely with the end customer.

TAP/TEP Technical Summary and Application Guidelines



A commonly held misconception is that the leakage current of a Tantalum capacitor can predict the number of failures which will be seen on a surge screen. This can be disproved by the results of an experiment carried out at AVX on 47µF 10V surface mount capacitors with different leakage currents. The results are summarized in the table below.

Leakage Current vs Number of Surge Failures

	Number tested	Number failed surge
Standard leakage range 0.1 µA to 1µA	10,000	25
Over Catalog limit 5µA to 50µA	10,000	26
Classified Short Circuit 50µA to 500µA	10,000	25

Again, it must be remembered that these results were derived from a highly accelerated surge test machine, and failure rates in the low ppm are more likely with the end customer.

AVX recommended derating table

Voltage Rail	Working Cap Voltage
3.3	6.3
5	10
10	20
12	25
15	35
≥24	Series Combinations (11)

For further details on surge in Tantalum capacitors refer to J.A. Gill's paper "Surge in Solid Tantalum Capacitors", available from AVX offices worldwide.

An added bonus of increasing the derating applied in a circuit, to improve the ability of the capacitor to withstand surge conditions, is that the steady-state reliability is improved by up to an order. Consider the example of a 6.3 volt capacitor being used on a 5 volt rail. The steady-state reliability of a Tantalum capacitor is affected by three parameters; temperature, series resistance and voltage derating. Assuming 40°C operation and 0.1Ω/volt of series resistance, the scaling factors for temperature and series resistance will both be 0.05 [see Section 3.1 (page 156)]. The derating factor will be 0.15. The capacitors reliability will therefore be

$$\begin{aligned} \text{Failure rate} &= F_U \times F_T \times F_R \times 1\%/1000 \text{ hours} \\ &= 0.15 \times 0.05 \times 1 \times 1\%/1000 \text{ hours} \\ &= 7.5\% \times 10^{-3}/\text{hours} \end{aligned}$$

If a 10 volt capacitor was used instead, the new scaling factor would be 0.017, thus the steady-state reliability would be

$$\begin{aligned} \text{Failure rate} &= F_U \times F_T \times F_R \times 1\%/1000 \text{ hours} \\ &= 0.017 \times 0.05 \times 1 \times 1\%/1000 \text{ hours} \\ &= 8.5\% \times 10^{-4}/1000 \text{ hours} \end{aligned}$$

So there is an order improvement in the capacitors steady-state reliability.

3.3 RELIABILITY TESTING

AVX performs extensive life testing on tantalum capacitors.

- 2,000 hour tests as part of our regular Quality Assurance Program.

Test conditions:

- 85°C/rated voltage/circuit impedance of 3Ω max.
- 125°C/0.67 x rated voltage/circuit impedance of 3Ω max.

3.4 Mode of Failure

This is normally an increase in leakage current which ultimately becomes a short circuit.

TAP/TEP Technical Summary and Application Guidelines



SECTION 4: APPLICATION GUIDELINES FOR TANTALUM CAPACITORS

4.1 SOLDERING CONDITIONS AND BOARD ATTACHMENT

The soldering temperature and time should be the minimum for a good connection.

A suitable combination for wavesoldering is 230°C - 250°C for 3 - 5 seconds.

Small parametric shifts may be noted immediately after wave solder, components should be allowed to stabilize at room temperature prior to electrical testing.

AVX leaded tantalum capacitors are designed for wave soldering operations.

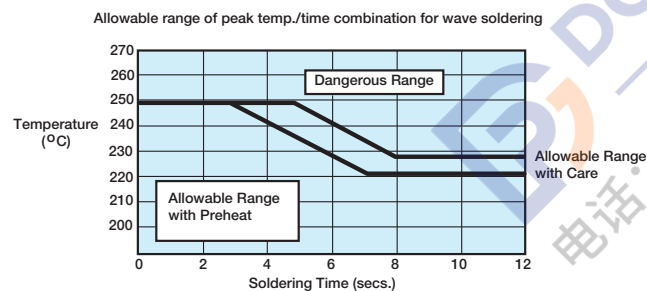

4.2 RECOMMENDED SOLDERING PROFILES

Recommended wave soldering profile for mounting of tantalum capacitors is shown below.

After soldering the assembly should preferably be allowed to cool naturally. In the event that assisted cooling is used, the rate of change in temperature should not exceed that used in reflow.

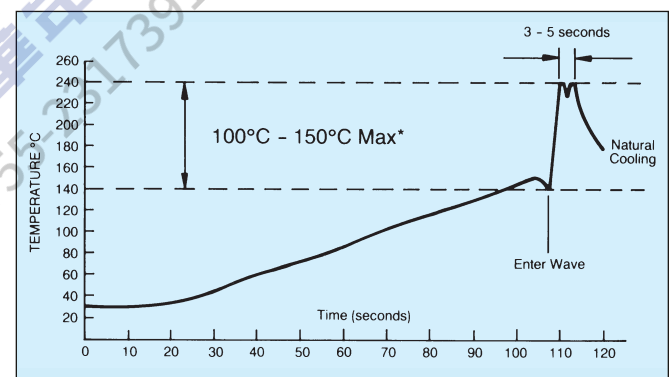

*See appropriate product specification

SECTION 5: MECHANICAL AND THERMAL PROPERTIES, LEADED CAPACITORS

5.1 ACCELERATION

10 g (981 m/s)

5.2 VIBRATION SEVERITY

10 to 2000 Hz, 0.75 mm or 98 m/s²

5.3 SHOCK

Trapezoidal Pulse 10 g (981 m/s) for 6 ms

5.4 TENSILE STRENGTH OF CONNECTION

10 N for type TAR, 5 N for type TAP/TEP.

5.5 BENDING STRENGTH OF CONNECTIONS

2 bends at 90°C with 50% of the tensile strength test loading.

5.6 SOLDERING CONDITIONS

Dip soldering permissible provided solder bath temperature $\leq 270^\circ\text{C}$; solder time < 3 sec.; circuit board thickness ≤ 1.0 mm.

5.7 INSTALLATION INSTRUCTIONS

The upper temperature limit (maximum capacitor surface temperature) must not be exceeded even under the most unfavorable conditions when the capacitor is installed. This must be considered particularly when it is positioned near components which radiate heat strongly (e.g., valves and power transistors). Furthermore, care must be taken, when bending the wires, that the bending forces do not strain the capacitor housing.

5.8 INSTALLATION POSITION

No restriction.

5.9 SOLDERING INSTRUCTIONS

Fluxes containing acids must not be used.

Technical Summary and Application Guidelines

QUESTIONS AND ANSWERS

Some commonly asked questions regarding Tantalum Capacitors:

Question: If I use several tantalum capacitors in serial/parallel combinations, how can I ensure equal current and voltage sharing?

Answer: Connecting two or more capacitors in series and parallel combinations allows almost any value and rating to be constructed for use in an application. For example, a capacitance of more than 60µF is required in a circuit for stable operation. The working voltage rail is 24 Volts dc with a superimposed ripple of 1.5 Volts at 120 Hz. The maximum voltage seen by the capacitor is $V_{dc} + V_{ac}=25.5V$

Applying the 50% derate rule tells us that a 50V capacitor is required.

Connecting two 25V rated capacitors in series will give the required capacitance voltage rating, but the effective capacitance will be halved, so for greater than

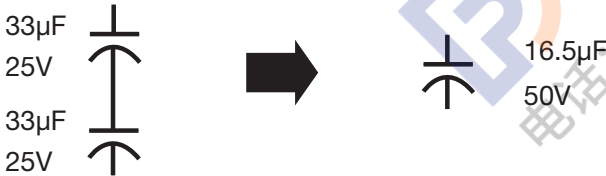

60µF, four such series combinations are required, as shown.

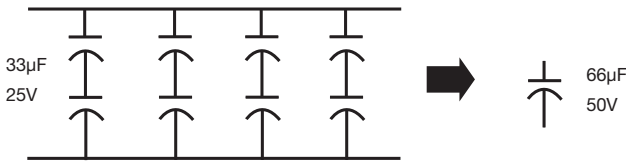

In order to ensure reliable operation, the capacitors should be connected as shown below to allow current sharing of the ac noise and ripple signals. This prevents any one capacitor heating more than its neighbors and thus being the weak link in the chain.

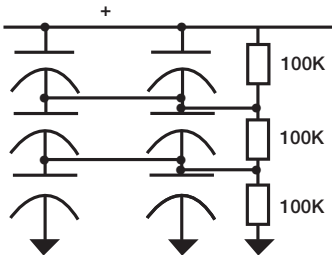

The two resistors are used to ensure that the leakage currents of the capacitors does not affect the circuit reliability, by ensuring that all the capacitors have half the working voltage across them.

Question: What are the advantages of tantalum over other capacitor technologies?

Answer:

1. Tantalums have high volumetric efficiency.
2. Electrical performance over temperature is very stable.
3. They have a wide operating temperature range -55 degrees C to +125 degrees C.
4. They have better frequency characteristics than aluminum electrolytics.
5. No wear out mechanism. Because of their construction, solid tantalum capacitors do not degrade in performance or reliability over time.

Question: If the part is rated as a 25 volt part and you have current surged it, why can't I use it at 25 volts in a low impedance circuit?

Answer: The high volumetric efficiency obtained using tantalum technology is accomplished by using an extremely thin film of tantalum pentoxide as the dielectric. Even an application of the relatively low voltage of 25 volts will produce a large field strength as seen by the dielectric. As a result of this, derating has a significant impact on reliability as described under the reliability section. The following example uses a 22 microfarad capacitor rated at 25 volts to illustrate the point. The equation for determining the amount of surface area for a capacitor is as follows:

$$C = (\epsilon (E_o) (A)) / d$$

$$A = (C (d)) / (\epsilon_o \epsilon)$$

$$A = ((22 \times 10^{-6}) (170 \times 10^{-9})) / ((8.85 \times 10^{-12}) (27))$$

$$A = 0.015 \text{ square meters (150 square centimeters)}$$

Where C = Capacitance in farads

- A = Dielectric (Electrode) Surface Area (m²)
- d = Dielectric thickness (Space between dielectric) (m)
- ε = Dielectric constant (27 for tantalum)
- ε° = Dielectric Constant relative to a vacuum (8.855 x 10⁻¹² Farads x m⁻¹)

To compute the field voltage potential felt by the dielectric we use the following logic.

$$\text{Dielectric formation potential} = \text{Formation Ratio} \times \text{Working Voltage}$$

$$= 4 \times 25$$

$$\text{Formation Potential} = 100 \text{ volts}$$

Dielectric (Ta₂O₅) Thickness (d) is 1.7 x 10⁻⁹ Meters Per Volt
d = 0.17 µ meters

$$\text{Electric Field Strength} = \text{Working Voltage} / d$$

$$= (25 / 0.17 \mu \text{ meters})$$

$$= 147 \text{ Kilovolts per millimeter}$$

$$= 147 \text{ Megavolts per meter}$$

Technical Summary and Application Guidelines



QUESTIONS AND ANSWERS

No matter how pure the raw tantalum powder or the precision of processing, there will always be impurity sites in the dielectric. We attempt to stress these sites in the factory with overvoltage surges, and elevated temperature burn in so that components will fail in the factory and not in your product. Unfortunately, within this large area of tantalum pentoxide, impurity sites will exist in all capacitors. To minimize the possibility of providing enough activation energy for these impurity sites to turn from an amorphous state to a crystalline state that will conduct energy, series resistance and derating is recommended. By reducing the electric field within the anode at these sites, the tantalum capacitor has increased reliability. Tantalums differ from other electrolytics in that charge transients are carried by electronic conduction rather than absorption of ions.

Question: What negative transients can Solid Tantalum Capacitors operate under?

Answer: The reverse voltage ratings are designed to cover exceptional conditions of small level excursions into incorrect polarity. The values quoted are not intended to cover continuous reverse operation. The peak reverse voltage applied to the capacitor must not exceed:

10% of rated DC working voltage to a maximum of 1 volt at 25°C.

3% of rated DC working voltage to a maximum of 0.5 volt at 85°C.

1% of category DC working voltage to a maximum of 0.1 volt at 125°C.

Question: I have read that manufacturers recommend a series resistance of 0.1 ohm per working volt. You suggest we use 1 ohm per volt in a low impedance circuit. Why?

Answer: We are talking about two very different sets of circuit conditions for those recommendations. The 0.1 ohm per volt recommendation is for steady-state conditions. This level of resistance is used as a basis for the series resistance variable in a 1% / 1000 hours 60% confidence level reference. This is what steady-state life tests are based on. The 1 ohm per volt is recommended for dynamic conditions which include current in-rush applications such as inputs to power supply circuits. In many power supply topologies where the di/dt through the capacitor(s) is limited, (such as most implementations of buck (current mode), forward converter, and flyback), the requirement for series resistance is decreased.

Question: How long is the shelf life for a tantalum capacitor?

Answer: Solid tantalum capacitors have no limitation on shelf life. The dielectric is stable and no reformation is required. The only factors that affect future performance of the capacitors would be high humidity conditions and extreme storage temperatures. Solderability of solder coated surfaces may be affected by storage in excess of 2 years. Recommended storage conditions are: Temperature between -10°C – +50°C with humidity 75% RH maximum and atmospheric pressure 860 mbar-1060 mbar. Terminations should be checked for solderability in the event an oxidation develops on the solder plating.

Question: Are any recommendations/limitation for capacitor selection in parallel combination of capacitors?

Answer: Higher performance series TPS, TPM, NOS, NOM, TCJ, TCN are designed to provide lower ESR values and make the product more robust against current surges. The design differences make the better performance distribution of parameters, namely ESR is lower and tighter compared to the general purpose TAJ series. The surge current load in a parallel combination of capacitors is therefore shared more evenly amongst the capacitors and thus it is better suited for this application.

In a parallel combination is is strongly recommended to use the low ESR series of Tantalum Capacitors such as TPS, TPM, NOS, NOM, TCJ and TCN. Do not combine different series of manufacturers within one parallel combination.

Question: What level of voltage derating is needed for Tantalum Capacitors?

Answer: For many years whenever people have asked a tantalum capacitor manufacturer about what were the safe guidelines for using their product, they spoke with one voice “a minimum of 50% voltage derating should be applied”. This message has since become ingrained and automatic. This article challenges this statement and explains why it is not necessarily the case.

The 50% rule came about when tantalum capacitors started to be used on low impedance sources. In such applications, the available current is high and therefore a risk of failure is inherent. Well established by empirical methods and covered in MIL-STD 317, was the fact that the amount of voltage derating has a major influence on the failure rate of a tantalum capacitor (Figure 1). Indeed, from rated voltage to 50% of rated voltage is an improvement in failure rate of more than 100.

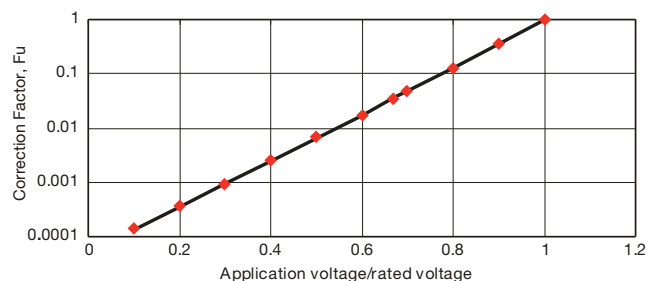
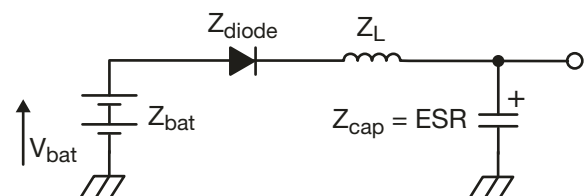

Figure 1

It was also proved that the same was true of dynamic, high current pulse conditions', hence the recommendation.

Now let us look more closely at the type of circuits in use. Below is a simple circuit which will be discussed further in this text.



Technical Summary and Application Guidelines



Let us assume this is a 2 cell battery system, therefore

$$V_{\text{bat}} = 3.2 \text{ Volts}$$

Also, let us assume

$$Z_{\text{bat}} = 60 \text{ m}\Omega, Z_{\text{diode}} = 70 \text{ m}\Omega, Z_{\text{cap}} = 120 \text{ m}\Omega, Z_L = 70 \text{ m}\Omega$$

If the “50% rule” was followed, the designer should chose a 6.3V rated capacitor.

The total circuit impedance of the system is 320 mΩ. So by Ohm’s law the peak current would be 10 Amps.

This exceeds the test conditions used by AVX to screen its product for high current pulses¹, so a risk of failure exists. Clearly a minimum of a 10 volt rate capacitor is required in this application.

As a general rule of thumb, the maximum current a tantalum capacitor can withstand (provided it has not been damaged by thermomechanical damage^{2 3} or some other external influence) is given by the equation:

$$I_{\text{max}} = V_{\text{rated}} / (1 + \text{Catalog ESR})$$

So for example for a 100μF 10V D case capacitor (Catalog ESR = 0.9 Ohms), this would be:

$$I_{\text{max}} = 10 / (1 + 0.9) = 5.2 \text{ Amps}$$

In some circuits, because of size restrictions, a tantalum capacitor may be the only option available. If this is the case, AVX recommends a PFET integrator be used to slow the voltage ramp at turn on, which in effect reduces the peak current, and therefore reduces the risk of failure⁴.

Now, let’s consider a continuation of the circuit with the addition of an LDO or DC/DC convertor.

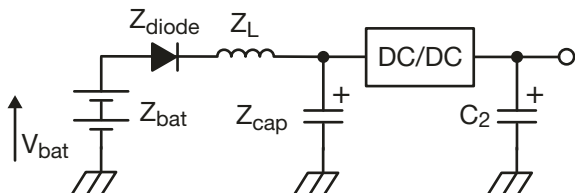

The risk of a high surge current being seen by the capacitor in location C₂ is very small. Therefore if we assume the voltage rail is 2.8 volts and the maximum current seen by C₂ is <1.5 Amps, a 4 volt capacitor could be able to be used in this application.

This all seems like good news, but as always, there are some downsides to using a part nearer to its rated voltage. The first is the steady-state life, or MTBF. The MTBF of a tantalum capacitor is easily calculated from MIL-STD 317 or the supplier’s catalog data. An example is given below:

Assume operating temperature is 85°C and circuit impedance 0.1 Ohms/volt (F_T = 1).

For a 10 volt rated capacitor on a 5 volt rated line, the failure rate is:

$$\begin{aligned} F_R &= 1\%/1000 \text{ hours} \times F_T \times F_U \times F_R \\ &= 1\%/1000 \text{ hours} \times 1 \times 0.007 \text{ (from Figure 1)} \times 1 \\ &= 0.007\%/1000 \text{ hours} \end{aligned}$$

$$\text{MTBF} = 10^5 / F_R$$

$$= 14,285,238 \text{ hours}$$

$$= 1,631 \text{ years}$$

For a 6.3 volt rated capacitor on a 5 volt rated line, the failure rate is:

$$\begin{aligned} F_R &= 1\%/1000 \text{ hours} \times F_T \times F_U \times F_R \\ &= 1\%/1000 \text{ hours} \times 1 \times 0.12 \text{ (from Figure 1)} \times 1 \\ &= 0.12\%/1000 \text{ hours} \end{aligned}$$

$$\text{MTBF} = 10^5 / F_R$$

$$= 833,333 \text{ hours}$$

$$= 95 \text{ years}$$

The second factor to be considered is that the more derating applied to a tantalum capacitor, the lower the leakage current level (Figure 2). Therefore a part used at 50% of its rated voltage will have more than 3 times better leakage levels than one used at 80%.

Leakage Current vs. Rated Voltage

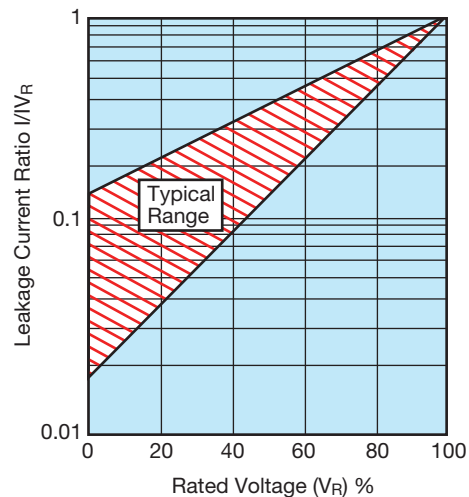

Figure 2

One final point worthy of mention with the introduction of higher reflow temperatures with the introduction of lead-free solders is that voltage derating can help to reduce the risk of failures due to thermomechanical damage during reflow.

To summarize, a tantalum capacitor is capable of being used at its rated voltage or close to it, provided that the user obeys the rules outlined in this document and is prepared for the reduced steady-state life performance and higher leakage current levels this would produce.

¹ Surge in Solid Tantalum Capacitors, John Gill, AVX Tantalum

² IR Reflow Guidelines for Tantalum Capacitors, Steve Warden & John Gill, AVX Tantalum

³ Mounting Guidelines in AVX Tantalum Catalog

⁴ Improving Reliability of Tantalum Capacitors in Low Impedance Circuits, Dave Mattingly, AVX

Technical Summary and Application Guidelines



Question: What does failure rate mean?

Answer: Failure rate is expressed as the number of parts (as a percentage) that can be expected to fail in a given time period under specific conditions of temperature, applied voltage (ratio to rated voltage - usually 1.0) and circuit impedance.

Question: What does ppm mean?

Answer: PPM is defined as 'PARTS PER MILLION' and can be used to express how many parts within a million pieces may fail to the specification.

Question: What is the difference between %/1000hrs and FITs?

Answer: The failure rate as the mathematic quantity can be expressed in several units of measurement - mostly in %/1000hrs or in FITs. FITs are usually used for the high-reliability components where expression in %/1000hrs would be more difficult to read. The conversion is as follows: e.g. 0.01%/1000hrs = 100 FIT for specified conditions ($[\%/1000\text{hrs}] = x 10000 [\text{FIT}]$).

Question: What are the standards for reliability calculations?

Answer: The standards used in the AVX specification are based on the European norm EN 61709 with the added feature of series resistance in order to better reflect real application conditions. The basic failure rate in the AVX test is given for conditions - 85°C, Vrated, 0.1 Ohm/V. To calculate the actual failure rate for specific conditions you have to consider the influence of different factors which have an impact on reliability - correction factors for temperature (FT), voltage derating (FV), (circuit) impedance (FR) and the base failure rate (Fbase) for the series being used.

Question: Are tantalum capacitors ESD (i.e. Electrostatic Discharge) sensitive devices?

Answer: All tantalum and niobium Oxide capacitors are not ESD sensitive devices.

Select-a-Cap Software

According to given application conditions and capacitor requirements (capacitance, case size), the Select-a-Cap tool offers suitable options from AVX's extensive product range and gives an overview of capacitor ratings for each option.

INPUT PARAMETERS

- Application voltage
- Serial circuit resistance
- Maximum current coming from the power supply
- Capacitor requirements

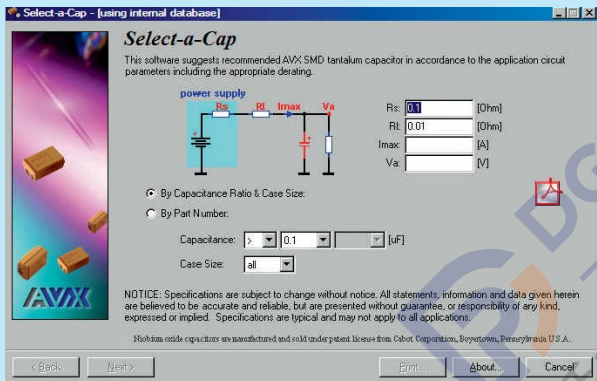

OUTPUT PARAMETERS

- Suggestion of part number
- Specification (Cap, DF, ESR, DCL)
- Max guaranteed surge current
- DCL @ application voltage
- Ripple current, ripple voltage
- Failure rate, MTBF with temperature

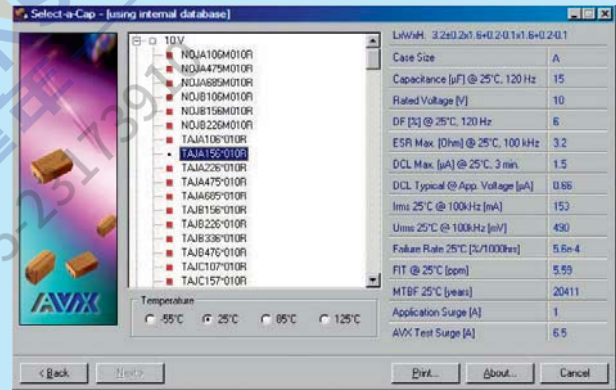

SpiTan III

Contains typical measured data of almost all released PNs and gives an overview of typical performance characteristic for tantalum and niobium oxide capacitors at different frequencies and temperatures. SpiTanIII does not contain the data from specification (for spec. limits see Select-a-Cap).

INPUT PARAMETERS

- Selected PN from the list with the help of filter (technology, capacitance, rated voltage, case, series, tolerance)



OUTPUT PARAMETERS

- Frequency characteristics of capacitance, impedance, ESR, DF for 25°C
- Temperature – shows performance according to selected operating temperature
- Frequency settings – shows values for given frequency
- Menu graph – shows additional performance figures for ripple characteristics (I,V), typical DCL performance within 5 min

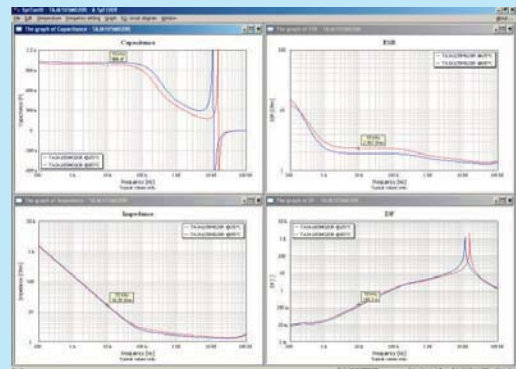

PSpice

PSpice library of tantalum capacitors suitable for high fidelity simulations with most of the PSpice software is available at AVX website.

PASSIVES

Capacitors

- Multilayer Ceramic
- Film
- Glass
- Niobium Oxide* - OxiCap®
- Pulse Supercapacitors
- Tantalum

Circuit Protection

- Thermistors
- Fuses - Thin Film
- Transient Voltage Suppressors
- Varistors - Zinc Oxide

Directional Couplers

- Thin-Film

Filters

- Ceramic
- EMI
- Noise
- SAW
- Low Pass - Thin Film

Inductors

- Thin-Film

Integrated Passive Components

- PMC - Thin-Film Networks
- Capacitor Arrays
- Feedthru Arrays
- Low Inductance Decoupling Arrays

Piezo Acoustic Generators

- Ceramic

Resistors

- Arrays
- Miniature Axials

Timing Devices

- Clock Oscillators
- MHz Quartz Crystal
- Resonators
- VCO
- TCXO

CONNECTORS

- Automotive
- Standard, Custom

- Board to Board
- SMD (0.4, 0.5, 1.0mm), BGA, Thru-Hole

- Card Edge

- DIN41612
- Standard, Inverse, High Temperature

- FFC/FPC
- 0.3, 0.5, 1.0mm

- Hand Held, Cellular
- Battery, I/O, SIMcard, RF shield clips

- 2mm Hard Metric
- Standard, Reduced Cross-Talk

- IDC Wire to Board
- Headers, Plugs, Assemblies

- Memory
- PCMCIA, Compact Flash, Secure Digital, MMC, Smartcard, SODIMM

- Military
- H Government, DIN41612

- Polytect™
- Soft Molding

- Rack and Panel
- Varicon™

**For more information please visit
our website at
<http://www.avx.com>**

NOTICE: Specifications are subject to change without notice. Contact your nearest AVX Sales Office for the latest specifications. All statements, information and data given herein are believed to be accurate and reliable, but are presented without guarantee, warranty, or responsibility of any kind, expressed or implied. Statements or suggestions concerning possible use of our products are made without representation or warranty that any such use is free of patent infringement and are not recommendations to infringe any patent. The user should not assume that all safety measures are indicated or that other measures may not be required. Specifications are typical and may not apply to all applications.

© AVX Corporation

"Niobium Oxide Capacitors are manufactured and sold under patent license from Cabot Corporation, Boyertown, Pennsylvania U.S.A."

SAMPLE WALLETS:

Number of PN's: 30

Number of pieces per PN: 5

ORANGE

OxiCap®

NOJ (Sample Kit: NOJ)

NOS, NOM (Sample Kit: NOS, NOM)



SILVER

TCJ, TAJ low, TLC, NOJ, TLJ, TLN
(Sample Kit: Mobile)



BLACK

Overview of our product series and matrixes
(Kit - Series)



BLUE

TAJ Auto, TPS Auto, THJ, TRJ (Sample Kit: Automotive)

TAJ (Sample Kit: TAJ)

TPS (Sample Kit: TPS)

THJ (Sample Kit: Hi Temp THJ)

TAJ, TCJ, TLN, TPM, TPS, TRJ, NOJ
(Sample Kit: Releases)

TRJ, TRM (Sample Kit: Industrial TRJ, TRM)

TPS, TPM (Sample Kit: Low ESR)

NOS, TPM, TPS, NOM (Sample Kit: Power Supply)

TPM (Sample Kit: TPM)

TAC (Sample Kit: TAC)



PALE GREY

TLJ (Sample Kit: TLJ Low Profile)



GREEN

Military and HI-REL Capacitors

CWR19, CWR29, CWR15 and various COTS+ products
available only through the Sales or Marketing channels



YELLOW

TCJ Voltage 2V-20V (Sample Kit: TCJ)

TCJ HiV Voltage 25V-125V (Sample Kit: TCJHIV)



AMERICAS

AVX Greenville, SC
Tel: 864-967-2150

AVX Northwest, WA
Tel: 360-699-8746

AVX Midwest, IN
Tel: 317-861-9184

AVX Mid/Pacific, CA
Tel: 408-988-4900

AVX Northeast, MA
Tel: 617-479-0345

AVX Southwest, CA
Tel: 949-859-9509

AVX Canada
Tel: 905-238-3151

AVX South America
Tel: +55-11-4688-1960

EUROPE

AVX Limited, England
Tel: +44-1276-697000

AVX S.A.S., France
Tel: +33-1-69-18-46-00

AVX GmbH, Germany
Tel: +49-0811-95949-0

AVX SRL, Italy
Tel: +39-02-614-571

AVX Czech Republic
Tel: +420-57-57-57-521

AVX/ELCO UK
Tel: +44-1638-675000

ELCO Europe GmbH
Tel: +49-2741-299-0

AVX S.A., Spain
Tel: +34-91-63-97-197

AVX Benelux
Tel: +31-187-489-337

ASIA-PACIFIC

**AVX/Kyocera (S) Pte Ltd.,
Singapore**
Tel: +65-6286-7555

**AVX/Kyocera, Asia, Ltd.,
Hong Kong**
Tel: +852-2363-3303

**AVX/Kyocera Yuhan Hoesa,
South Korea**
Tel: +82-2785-6504

**AVX/Kyocera HK Ltd.,
Taiwan**
Tel: +886-2-2656-0258

**AVX/Kyocera (M) Sdn Bhd,
Malaysia**
Tel: +60-4228-1190

**AVX/Kyocera International
Trading Co. Ltd.,
Shanghai**
Tel: +86-21-3255 1933

**AVX/Kyocera Asia Ltd.,
Shenzen**
Tel: +86-755-3336-0615

**AVX/Kyocera International
Trading Co. Ltd.,
Beijing**
Tel: +86-10-6588-3528

**AVX/Kyocera India
Liaison Office**
Tel: +91-80-6450-0715

ASIA-KED

(KYOCERA Electronic Devices)

KED Hong Kong Ltd.
Tel: +852-2305-1080/1223

**KED Hong Kong Ltd.
Shenzen**
Tel: +86-755-3398-9600

**KED Company Ltd.
Shanghai**
Tel: +86-21-3255-1833

**KED Hong Kong Ltd.
Beijing**
Tel: +86-10-5869-4655

KED Taiwan Ltd.
Tel: +886-2-2950-0268

**KED Korea Yuhan Hoesa,
South Korea**
Tel: +82-2-783-3604/6126

**KED (S) Pte Ltd.
Singapore**
Tel: +65-6509-0328

**Kyocera Corporation
Japan**
Tel: +81-75-604-3449

Contact:



<http://www.avx.com>

S-TL0M613-C