

抗硫化厚膜贴片电阻承认书-AS 系列

Approval Specification for Anti- Sulfuration Thick Film Chip Resistors-Type **AS**

1. 范围 (scope) :

1.1 适用于本公司所生产的无铅、抗硫化厚膜贴片电阻 AS 系列

This specification applies to Anti-Sulfuration thick film chip resistors which meet requirements of Pb free.

1.2 本公司的无铅产品指的贴片电阻端电极无铅，而存在于电阻层的玻璃中的符合 RoHS 豁免条款。

There no lead exists in terminal of resistor, and lead which exist in glass of resistor layer meets RoHS exemption.

1.3 符合 AEC-200 标准。

Comply with AEC-Q200 standard.

2. 产品料号 (part number) :

0603 1/10W 5% 100 Ω



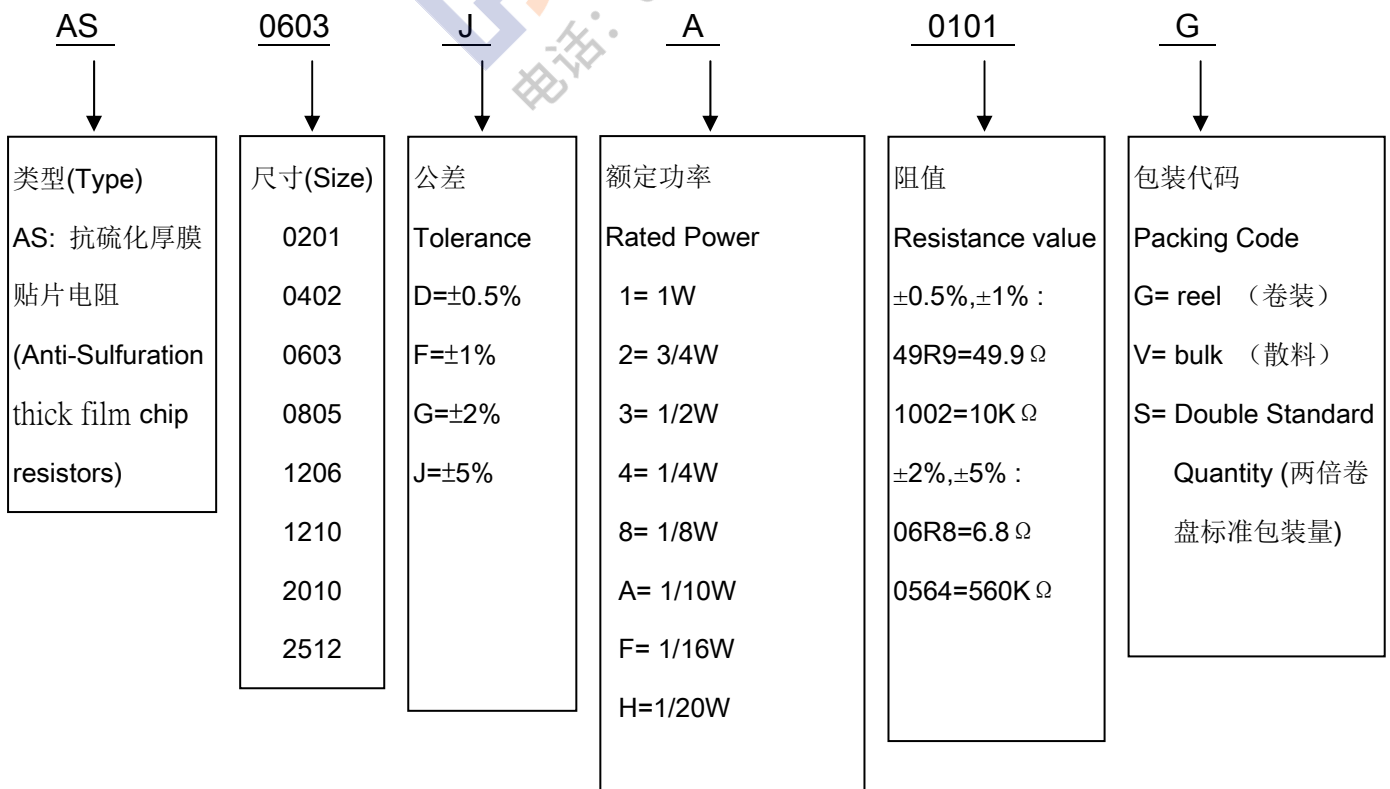

AS0603JA0101G



抗硫化厚膜贴片电阻承认书-AS 系列

Approval Specification for Anti- Sulfuration Thick Film Chip Resistors-Type **AS**

3. 电阻本体字码标示 (Marking on the Resistor's Body):

<p>※ AS0201、AS0402 因本体太小，本体上无字码标示 For AS0201、AS0402 size, no marking on the body due to the small size of the resistor.</p>		$472=47 \times 10^2=4.7K \Omega$
<p>※ 公差±5%的产品，以三字码标公差±5%的产品，以三字码标示，前两位表示阻值的有效数字，最后一位表示 10 的乘幂 ±5% tolerance product: the marking is 3 digits, the first 2 digits are significant figures of resistance value and the 3rd one denotes the power number of 10, (10^x).</p>		10Ω 以下标示：5R6=5.6Ω Below 10Ω: 5R6=5.6Ω
<p>※ ±1%的产品，以四字码标示，前三位表示阻值的有效数字，最后一位表示 10 的乘幂 ±1% tolerance product: the marking is 4 digits, the first 3 digits are significant figures of resistance value and the 4th one denotes the power number of 10, (10^x).</p>		$4992=499 \times 10^2=49.9K \Omega$
<p>※ AS0603 ±1% E96 系列的标准阻值，因电阻本体太小，采用三位代码标示。 Standard E96 series values of AS0603 ±1%: due to the small size of the resistor's body, use 3digits code to indicate the resistance value.</p>		100Ω 以下标示：6R81=6.81Ω Below 100Ω: 6R81=6.81Ω
<p>※ 0 欧姆产品，采用 000 三位代码标示。 0Ω Products, use 000 3digits code to indicate the resistance value.</p>		$000=0 \Omega$

抗硫化厚膜贴片电阻承认书-AS 系列

Approval Specification for Anti- Sulfuration Thick Film Chip Resistors-Type AS

AS0603 ±1% E96 系列的标准阻值代码(Standard E96 Series Resistance Value Code for 0603 ±1% Marking)

代码 Code	阻值 Value	代码 Code	阻值 Value	代码 Code	阻值 Value	代码 Code	阻值 Value	代码 Code	阻值 Value	代码 Code	阻值 Value
01	100	17	147	33	215	49	316	65	464	81	681
02	102	18	150	34	221	50	324	66	475	82	698
03	105	19	154	35	226	51	332	67	487	83	715
04	107	20	158	36	232	52	340	68	499	84	732
05	110	21	162	37	237	53	348	69	511	85	750
06	113	22	165	38	243	54	357	70	523	86	768
07	115	23	169	39	249	55	365	71	536	87	787
08	118	24	174	40	255	56	374	72	549	88	806
09	121	25	178	41	261	57	383	73	562	89	825
10	124	26	182	42	267	58	392	74	576	90	845
11	127	27	187	43	274	59	402	75	590	91	866
12	130	28	191	44	280	60	412	76	604	92	887
13	133	29	196	45	287	61	422	77	619	93	909
14	137	30	200	46	294	62	432	78	634	94	931
15	140	31	205	47	301	63	442	79	649	95	953
16	143	32	210	48	309	64	453	80	665	96	976

AS0603 ±1% E96 系列的指数代码(Multiplier Code for AS0603 ±1% Marking)

代码 Code	Y	X	A	B	C	D	E	F
指数 Multiplier	10 ⁻²	10 ⁻¹	10 ⁰	10 ¹	10 ²	10 ³	10 ⁴	10 ⁵

阻值标示如下(So the resistance value are marked as the following examples)



$$10D=124 \times 10^3=124K \Omega$$



$$38Y=243 \times 10^{-2}=2.43 \Omega$$

AS0603 ±1%的产品，在标准 E24 系列中，但不属于 E96 系列，标示与 5%的字码相同，但是在字码下加一条线
 Standard E24 and not belong to E96 series values of AS0603 ±1%, the marking is the same as 5% tolerance but marking as underline



$$\underline{331}=33 \times 10^1=330 \Omega$$



$$\underline{560}=56 \times 10^0=56 \Omega$$

抗硫化厚膜贴片电阻承认书-AS 系列

Approval Specification for Anti- Sulfuration Thick Film Chip Resistors-Type **AS**

4. 尺寸 (dimension) :

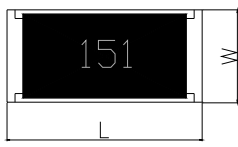
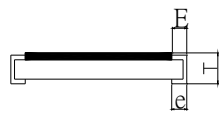
尺寸 dimension					
	单位 (unit) : mm				
型别 (Type)	L	W	T	E	e
AS0201	0.60±0.03	0.30±0.03	0.23±0.03	0.10±0.05	0.15±0.05
AS0402	1.00±0.05	0.50±0.05	0.30±0.05	0.15±0.10	0.20±0.10
AS0603	1.60±0.10	0.80±0.10	0.45±0.10	0.25±0.20	0.30±0.20
AS0805	2.00±0.15	1.25±0.15	0.50±0.10	0.35±0.20	0.40±0.20
AS1206	3.10±0.15	1.60±0.15	0.55±0.10	0.45±0.25	0.40±0.25
AS1210	3.10±0.15	2.50±0.15	0.55±0.15	0.35±0.25	0.60±0.25
AS2010	5.00±0.20	2.50±0.20	0.55±0.15	0.65±0.25	0.50±0.25
AS2512	6.25±0.20	3.10±0.20	0.55±0.15	0.85±0.25	0.95±0.25

5. 功率衰减曲线 (Derating Curve) :

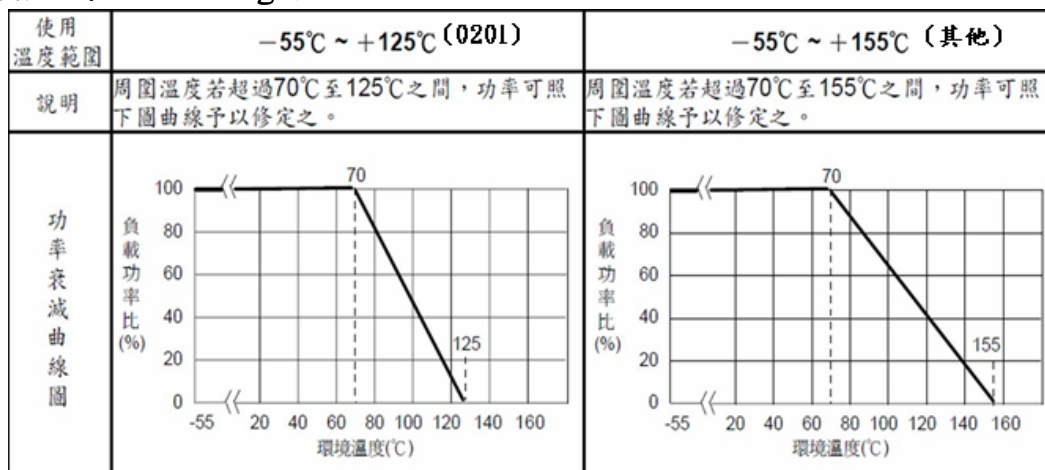

工作温度范围 (Operating Temperature Range) : -55°C~+125°C (0201 规格);

-55°C~+155°C (其他规格)

储存条件 (storage condition) : 5~30°C, 30~75%RH.

6. 脉冲功率曲线 (Curve of Pulse Duration) :

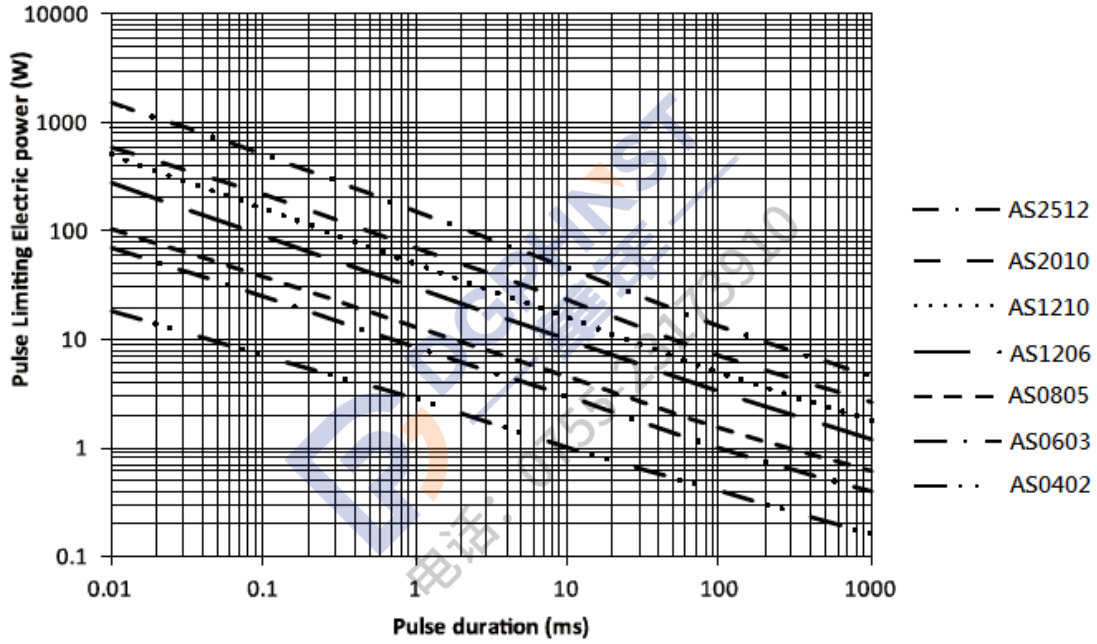

7. 电阻结构 (Construction) :

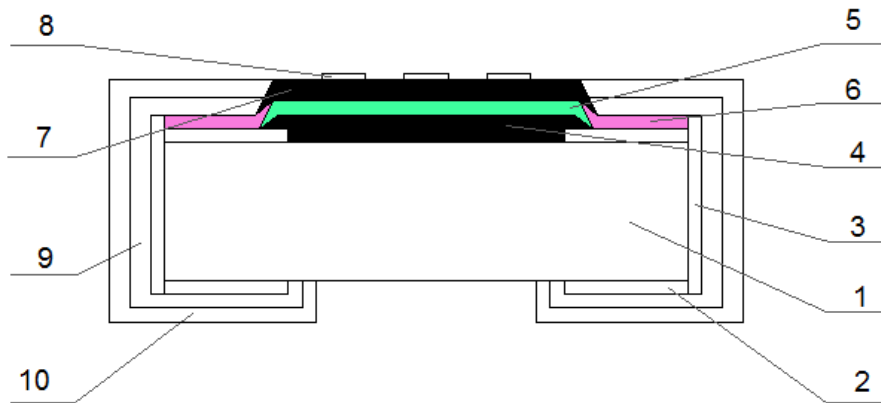

抗硫化厚膜贴片电阻承认书-AS 系列

Approval Specification for Anti- Sulfuration Thick Film Chip Resistors-Type **AS**

No.	结构 construction	主要材料 Major material
1	陶瓷基板	三氧化二铝 Al ₂ O ₃
2	银电极	银钯 AgPd
3	侧电极	镍铬合金 NiCr
4	阻体层	氧化钌+玻璃 RuO ₂ + glass
5	内保护层	玻璃 Glass
6	抗硫化层	抗硫膏
7	外保护层	环氧树脂 Epoxy
8	文字	环氧树脂 Epoxy
9	镍电极	镍 Ni
10	锡电极	雾锡 Matte Tin

8. 阻值范围 (resistance range) :

型别 Type	阻值范围 Resistance Range		
	0.5%	1%	2%&5%
AS0201	10Ω~10MΩ	1Ω~10MΩ, Jumper	1Ω~10MΩ, Jumper
AS0402	10Ω~10MΩ	1Ω~22MΩ, Jumper	1Ω~22MΩ, Jumper
AS0603	10Ω~10MΩ	1Ω~22MΩ, Jumper	1Ω~22MΩ, Jumper
AS0805	10Ω~10MΩ	1Ω~22MΩ, Jumper	1Ω~22MΩ, Jumper
AS1206	10Ω~10MΩ	1Ω~22MΩ, Jumper	1Ω~22MΩ, Jumper
AS1210	10Ω~10MΩ	1Ω~22MΩ, Jumper	1Ω~22MΩ, Jumper
AS2010	10Ω~10MΩ	1Ω~22MΩ, Jumper	1Ω~22MΩ, Jumper
AS2512	10Ω~10MΩ	1Ω~22MΩ, Jumper	1Ω~22MΩ, Jumper

9. 电气特性 (electrical characteristics) :

型别 Type	AS0201	AS0402	AS0603	AS0805	AS1206	AS1210	AS2010	AS2512
额定功率 Rated power	1/20W	1/16W	1/10W	1/8W	1/4W	1/2W	3/4W	1W
最大工作电压 Max Working Voltage	25V	50V	75V	150V	200V	200V	200V	200V
最大过负荷电压 Max Overload Voltage	50V	100V	150V	300V	400V	500V	500V	500V
绝缘耐压 Dielectric Withstanding Voltage	75V	150V	220V	430V	570V	710V	710V	710V
零欧姆阻值 Resistance Value of Jumper	<50mΩ	<50mΩ	<50mΩ	<50mΩ	<50mΩ	<50mΩ	<50mΩ	<50mΩ
零欧姆额定电流 Rated Current of Jumper	0.5A	1.0A	1.0A	2.0A	2.0A	2.0A	2.0A	2.0A
零欧姆电阻最大电流 Max Current of Jumper	1.0A	2.0A	2.0A	5.0A	10.0A	10.0A	10.0A	10.0A

备注 (remark) :

※ 额定电压计算公式 (The rated voltage is calculated by the following formula) :

$$E = \sqrt{RP}$$

E : 额定电压 (Rated Voltage) (V)

P : 额定功率 (Rated Power) (W)

R : 电阻阻值 (Resistance) (ohm)

※ 如果计算出的电压超过此型别的最大工作电压, 则此型别的最大工作电压为此电阻的额定电压。

In case the value calculated by the formula exceed the maximum working voltage as above table 9, the maximum working voltage shall be regarded as rated voltage.

抗硫化厚膜贴片电阻承认书-AS 系列

Approval Specification for Anti- Sulfuration Thick Film Chip Resistors-Type **AS**

10.性能信赖性测试 (Performance Reliability Test Methods)

内容 Item	测试方法 Test Methods	测试条件 Test Conditions	规格 Specification
温度系数 Temperature Coefficient	JIS C 5201 4.8	$TCR = (R - R_0) / (t - t_0) R_0 \times 10^6$ (ppm) R_0 电阻在室温下的阻值(resistance at room temperature) R 电阻在 125°C 或 -55°C 下的阻值(resistance at 125°C or -55°C) t_0 室温(room temperature) t 测试温度 (test temperature 125°C or -55°C)	0201 规格： $1\Omega \leq R \leq 10\Omega$ ： -100~+300PPM/°C $10\Omega < R \leq 10M\Omega$ ： ± 200 PPM/°C 0402~2512 规格： $1\Omega \leq R \leq 10\Omega$ ： ± 200 PPM/°C $10\Omega < R \leq 10M\Omega$ ： ± 100 PPM/°C $> 10M\Omega$ ： ± 200 PPM/°C
焊锡性 Solderability	J-STD-002	用于引脚型和表面贴装型元件，不需要电气测试，放大倍数 50 倍。 测试条件： 表面贴装型： a) 方法 B, 干热 @155°C, 4 小时, @235°C, 3±0.5 秒 b) 方法 B, 蒸煮 8 小时, @235°C, 3±0.5 秒 For pin and surface-mount components, no electrical testing required. Magnification 50 times. Test conditions: Surface mount type: a) Method B: dry heat @155°C, 4 hours, @235°C, 3±0.5 seconds b) Method B: cook for 8 hours at @235°C, 3±0.5 seconds	最少 95% 面积上锡 (Min 95% coverage)
绝缘电阻 Insulation resistance	JIS C 5201 4.6	电阻本体上加载绝缘耐压 60±5 秒后，测量绝缘阻抗 Applied the dielectric withstanding voltage on the center of body for 60±5seconds. Then measure insulation resistance	>10GΩ

抗硫化厚膜贴片电阻承认书-AS 系列

Approval Specification for Anti- Sulfuration Thick Film Chip Resistors-Type **AS**

内容 Item	测试方法 Test Methods	测试条件 Test Conditions	规格 Specification
绝缘耐压 Dielectric withstanding voltage	JIS C 5201 4.7	电阻本体上加载绝缘耐压 60±5 秒。 Applied the dielectric withstanding voltage on the center of body for 60±5 seconds.	无击穿、飞弧及可见机械性损伤 No evidence of flashover, mechanical damage arcing or insulation breakdown
短时间过负荷 Short-time overload	JIS C 5201 4.13	加载 2.5 倍的额定电压，时间 5 秒后测量试验前后的阻值变化率。 Applied 2.5 times of rated voltage for 5 second. Measure the variation of resistance. $\Delta R\% = \frac{R_2 - R_1}{R_1} * 100 \text{-----} (\%)$ R1 = 试验前阻值(resistance before test) R2 = 试验后阻值(resistance after test)	±(1.00%+0.05 Ω) Max
抗焊锡热 Resistance to soldering heat	MIL-STD-202 METHOD 210	锡炉温度 260±5℃, 时间 10±0.5 秒，样品不进行预热。注意: 单一波峰焊-表面贴装元件按程序，浸入器件本体的 1.5mm 的深度。Soldering bath at 260±5℃ for 10±0.5sec. No pre-heat of samples. Note: Single Wave Solder-Procedure 2 for SMD and Procedure 1 for Leaded with solder within 1.5mm of device body. $\Delta R\% = \frac{R_2 - R_1}{R_1} * 100 \text{-----} (\%)$ R1 = 试验前阻值(resistance before test) R2 = 试验后阻值(resistance after test)	±(1.00%+0.05 Ω) Max
端子弯曲 Board Flex	AEC-Q200-005	焊接在 PCB 板上，0201~1206 弯板深度 5mm，1210 以上弯板深度 2mm；保持 60±1s Reflow solder the samples on PCB，0201~1206 bending plate depth 5mm, 1210 above bending plate depth 2mm; Keep 60±1 s $\Delta R\% = \frac{R_2 - R_1}{R_1} * 100 \text{-----} (\%)$ R1 = 试验前阻值(resistance before test) R2 = 试验后阻值(resistance after test)	±(1.00%+0.05 Ω) Max

抗硫化厚膜贴片电阻承认书-AS 系列

Approval Specification for Anti- Sulfuration Thick Film Chip Resistors-Type **AS**

内容 Item	测试方法 Test Methods	测试条件 Test Conditions	规格 Specification
负荷寿命 Operational life	MIL-STD-202 METHOD 108	恒定温度 125 °C 加载 额定功率，ON TIME:1.5H，OFF TIME:0.5H，额定电压 1000 ⁺²⁴ / ₀ 小时 Load rated power, ON TIME:1.5H, OFF TIME:0.5H, rated voltage 1000 +24/-0 hours $\Delta R\% = \frac{R_2 - R_1}{R_1} * 100 \text{-----} (\%)$ R1 = 试验前阻值(resistance before test) R2 = 试验后阻值(resistance after test)	±(2.00%+0.05 Ω) Max
耐湿特性 Biased Humidity	MIL-STD-202 METHOD 103	加载 10%额定功率，85°C/85%RH, 持续通电 1000H,试验结束 24±4 小时后进行测 试 1000 hours 85°C/85%RH. Note: Specified conditions: 10% of operating power. Measurement at 24±4 hours after test conclusion. $\Delta R\% = \frac{R_2 - R_1}{R_1} * 100 \text{-----} (\%)$ R1 = 试验前阻值(resistance before test) R2 = 试验后阻值(resistance after test)	±(2.00%+0.05 Ω) Max
温度循环 Temperature cycling	JESD22 METHOD JA -104	-55°C~+155°C，循环 1000 次，在每一个极限温 度持续时间不超过 30 分钟，且温度转换时间 不超过 1 分钟，试验结束 24±4 小时后进行测 试。 1000 Cycles (-55°C to +155°C) Measurement at 24±4 hours after test conclusion. 30min maximum dwell time at each temperature extreme. 1min. maximum transition time. $\Delta R\% = \frac{R_2 - R_1}{R_1} * 100 \text{-----} (\%)$ R1 = 试验前阻值(resistance before test) R2 = 试验后阻值(resistance after test)	±(2.0%+0.05 Ω) Max

抗硫化厚膜贴片电阻承认书-AS 系列

Approval Specification for Anti- Sulfuration Thick Film Chip Resistors-Type **AS**

内容 Item	测试方法 Test Methods	测试条件 Test Conditions	规格 Specification
温湿循环 Moisture resistance	MIL-STD-202 METHOD 106	25 ° C~65 ° C,90~100%RH, 2.5 小时 ; 65 ° C 90~100%RH, 3小时; 65°C~25°C,80~100%RH,2.5小时,10个循环,试验 结束24±4小时后进行测试. 25 ° C~65 ° C,90~100%RH, 2.5H; 65 ° C 90~100%RH, 3H; 65°C~25°C 80~100%RH, 2.5H, 10 cycles, Measurement at 24±4 hours after test conclusion. $\Delta R\% = \frac{R_2 - R_1}{R_1} * 100 \text{-----} (\%)$ R1 = 试验前阻值(resistance before test) R2 = 试验后阻值(resistance after test)	±(2.00%+0.05 Ω) Max
高温储存 High Temperature Exposure(Storage)	MIL-STD-202 METHOD 108	155°C 下放置 1000h,不加载功率 , 试验结束 24±4 小时后进行测试. 1000 hrs. @ T=155°C. Unpowered. Measurement at 24±4 hours after test conclusion $\Delta R\% = \frac{R_2 - R_1}{R_1} * 100 \text{-----} (\%)$ R1 = 试验前阻值(resistance before test) R2 = 试验后阻值(resistance after test)	±(1.00%+0.05 Ω) Max
ESD 试验 ESD test	AEC-Q200-002	加载规定静电电压2次/间隔1秒 , 0201/0402规格:0.5KV, 0603规格:1KV, 其它规格2KV: 0201/0402:0.5KV, 0603: 1.0KV, Other:2KV, 2times/1s $\Delta R\% = \frac{R_2 - R_1}{R_1} * 100 \text{-----} (\%)$ R1 = 试验前阻值(resistance before test) R2 = 试验后阻值(resistance after test)	±(3.0%+0.05 Ω) Max

抗硫化厚膜贴片电阻承认书-AS 系列

Approval Specification for Anti- Sulfuration Thick Film Chip Resistors-Type **AS**

内容 Item	测试方法 Test Methods	测试条件 Test Conditions	规格 Specification
抗硫化试验 Sulfuration test	ANSI/EIA-977	<p>方法一：在玻璃容器底部的培养皿上铺满10mm厚的硫粉，烘烤105℃，750hrs</p> <p>方法二：切削油:硫粉=96.5:3.5，温度105℃，100H;</p> <p>预处理：前后先经历3次回流焊+100次温冲</p> <p>Method 1: cover the tray or base of the chamber with a bed of sulfur to 10 mm depth minimum, bake at 105℃, 750hrs</p> <p>Method 2: cutting oil: sulfur powder =96.5:3.5, temperature 105℃, 100H;</p> <p>Pretreatment: before and after three reflow soldering +100 thermal shock</p> $\Delta R\% = \frac{R_2 - R_1}{R_1} * 100 \quad (\%)$ <p>R1 = 试验前阻值(resistance before test) R2 = 试验后阻值(resistance after test)</p>	±(3.0% +0.05 Ω) Max

11. 包装规格 (Tapping Specification)

11.1 卷盘尺寸 (reel dimension)

尺寸 Dimensions		A	B	C	F	W
AS0201 AS0402 AS0603 AS0805	mm	178±2.0	60.0±1.0	13.5±0.5	11.4±0.1	9.00±0.3
AS1206 AS1210	Inch	7.008±0.079	2.362±0.039	0.531±0.020	0.449±0.039	0.354±0.012
AS2010 AS2512	mm	178±2.0	60.0±1.0	13.5±0.5	15.4±1.0	13.0±0.3
	Inch	7.008±0.079	2.362±0.039	0.531±0.020	0.606±0.039	0.512±0.012

※ 备注 (Remark) : (1) 0201/0402 每卷 10,000 pcs
0201/0402 Quantity per Reel 10,000 pcs/Reel

抗硫化厚膜贴片电阻承认书-AS 系列

Approval Specification for Anti- Sulfuration Thick Film Chip Resistors-Type AS

- (2) 2010/2512 每卷 4,000 pcs
2010/2512 Quantity per Reel 4,000 pcs/Reel
- (3) 0603/0805/1206/1210 每卷 5,000pcs
0603/0805/1206/1210 Quantity per Reel 5,000 pcs/Reel
- (4) 0402 可依客户要求每卷 20,000pcs
0402 Quantity per Reel 20,000 pcs/Reel as customer requirement

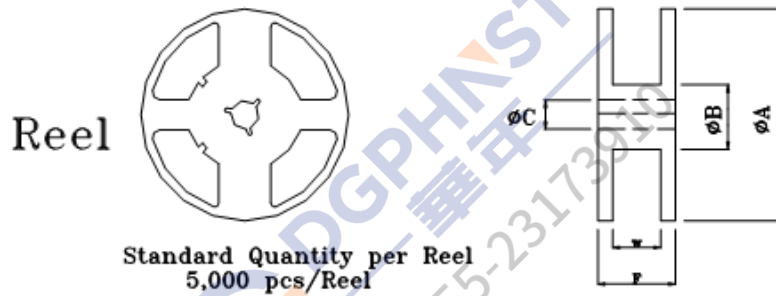

11.2 包装尺寸 (packing dimension)

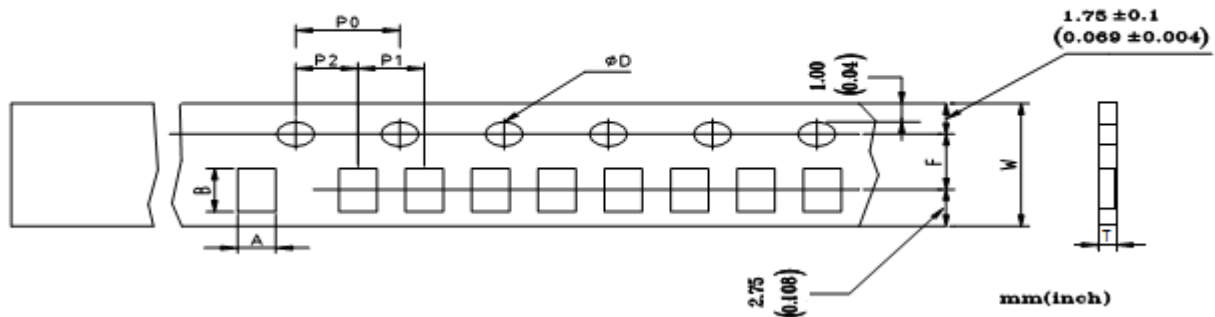

Unit: mm

Dimensions	A	B	D	F	P0	P1	P2	W	T
AS0201	0.38±0.05	0.68±0.05	1.50± ^{0.1} / _{0.0}	3.50±0.05	4.00±0.10	2.00±0.10	2.00±0.05	8.00±0.20	0.42±0.07
AS0402	0.65±0.10	1.15±0.10	1.50± ^{0.1} / _{0.0}	3.50±0.05	4.00±0.10	2.00±0.10	2.00±0.05	8.00±0.20	0.42±0.07
AS0603	1.10±0.10	1.90±0.10	1.50± ^{0.1} / _{0.0}	3.50±0.05	4.00±0.10	4.00±0.10	2.00±0.05	8.00±0.20	0.60±0.07
AS0805	1.65±0.20	2.40±0.20	1.50± ^{0.1} / _{0.0}	3.50±0.05	4.00±0.10	4.00±0.10	2.00±0.05	8.00±0.20	0.75±0.07
AS1206	2.00±0.20	3.60±0.20	1.50± ^{0.1} / _{0.0}	3.50±0.05	4.00±0.10	4.00±0.10	2.00±0.05	8.00±0.20	0.75±0.07
AS1210	2.80±0.20	3.50±0.20	1.50± ^{0.1} / _{0.0}	3.50±0.05	4.00±0.10	4.00±0.10	2.00±0.05	8.00±0.20	0.75±0.07
AS2010	2.90±0.10	5.30±0.10	1.50± ^{0.1} / _{0.0}	5.50±0.05	4.00±0.10	4.00±0.10	2.00±0.05	12.0±0.10	1.0±0.07
AS2512	3.40±0.10	6.60±0.10	1.50± ^{0.1} / _{0.0}	5.50±0.05	4.00±0.10	4.00±0.10	2.00±0.05	12.0±0.10	1.0±0.07

Approval Specification for Anti- Sulfuration Thick Film Chip Resistors-Type AS

12. 上胶带剥离力测试 (Peel force of top cover tape)

上胶带以 200mm/分钟的速度，沿 165~180 度角的方向进行剥离，如下图所示。纸带的剥离力范围为 10g~70g; 载带的剥离力范围为 15~80g

The top cover tape is pulled at a speed of 200 mm/min with the angle between the tape during peel and the direction of unreeling maintained at 165 to 180 degree as following picture. The peel force of paper carrier tape shall be 0.1N to 0.7N (10 to 70 g), the peel force of plastic carrier tape shall be 0.15N to 0.80N (15 to 80 g)

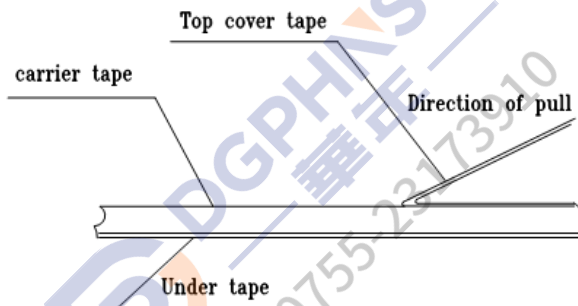

13. 焊盘尺寸 (Recommended land patterns):

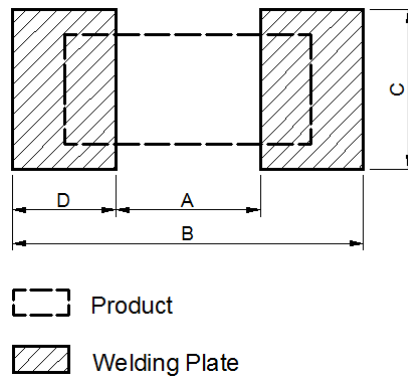

Type	Land pattern	Dimensions (mm)			
		A	B	C	D
AS0201		0.25~0.30	0.70~0.90	0.30~0.40	0.23~0.28
AS0402		0.50~0.60	1.40~1.60	0.40~0.60	0.42~0.52
AS0603		0.70~0.90	2.00~2.20	0.80~1.00	0.60~0.70
AS0805		1.00~1.40	3.20~3.80	0.90~1.40	1.10~1.20
AS1206		2.00~2.40	4.40~5.00	1.20~1.80	1.15~1.35
AS1210		2.00~2.40	4.40~5.00	2.30~3.50	1.15~1.35
AS2010		3.30~3.70	5.70~6.50	2.30~3.50	1.20~1.40
AS2512		3.60~4.00	7.60~8.60	2.30~3.50	2.05~2.25

Approval Specification for Anti- Sulfuration Thick Film Chip Resistors-Type **AS**

14. 焊接 (soldering)

14.1 建议回流焊曲线 (Recommend reflow soldering profile)

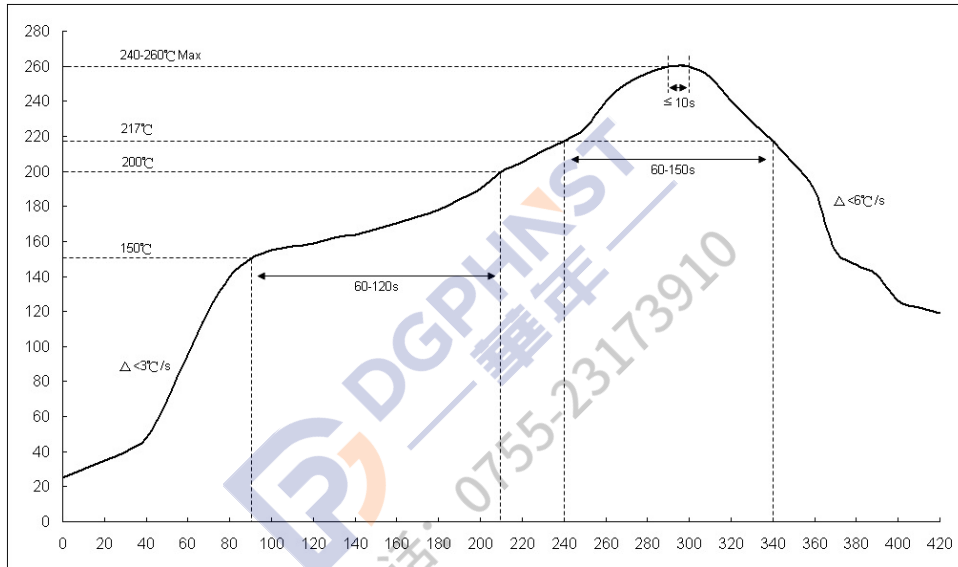

14.2 建议波峰焊曲线 (Recommend wave soldering profile)

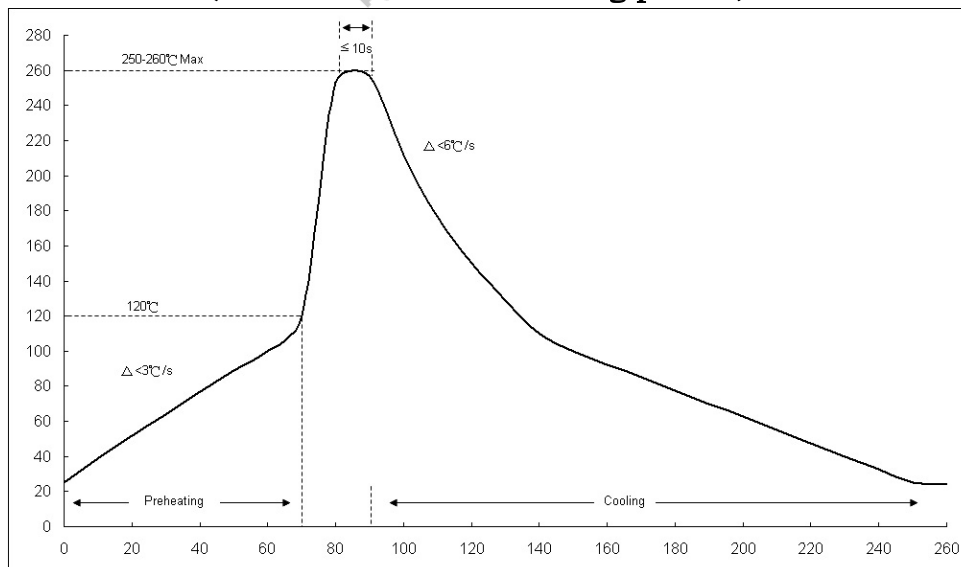

14.3 手工焊温度 (hand soldering temperature)

烙鐵溫度 $350 \pm 10^{\circ}\text{C}$ 3 秒之內，避免烙鐵接觸電阻本體

The iron temperature is $350 \pm 10^{\circ}\text{C}$, hand soldering time less than 3S. Avoid solder iron tip direct touch the components body.

产品规格及资料如有更改，恕不另行通知。

All product specification and data are subject to change without notice.