



MFR Series Metal Foil Low-Resistance Resistor Product Specifications

Document No.	S-10-12-07-07
Released Date	2022/04/11
Page No.	1/11

■ Metal Foil Low Resistance Chip Resistor — MFR Series

■ Application

- Entertainment
- Power supply
- Measuring instrument
- Industrial
- Battery management system

■ Features

- Excellent long term stability
- RoHs compliant and halogen free.
- Lead free.
- High precision current sensing and voltage division.
- Low Resistance / TCR / EMF (only for MnCu)/ Inductance($\leq 5nH$)

■ Product structure:

- (1) - Substrate : Alumina Ceramic
- (2) - Adhesive : Epoxy
- (3) - Resistive element : Cu – alloy
- (4) - Terminal electrode : Sn、Ni、Cu
- (5) - Protective coating : Flame-retardant epoxy, meets UL- 94-V0 requirements(green)
- (6) - Marking coating : Flame-retardant epoxy, meets UL- 94-V0 requirements (black)

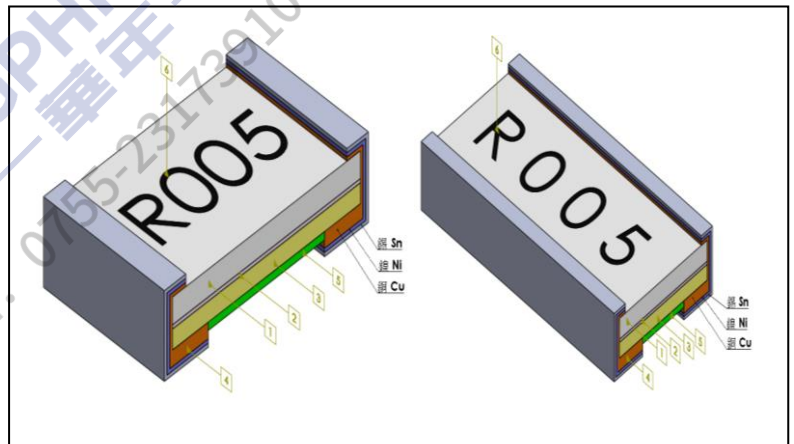

■ Parts Number Explanation

Example:

MFR	2512	20	F	R005	M	Z
Product Type	Size (Inch)	Rated Power	Tolerance	Resistance	Material	Optional
	0603 0805 1206 2010 2512 3921 4527 0508 0612 0815 1225 2139	05=0.50W 07=0.75W 10=1.00W 15=1.50W 20=2.00W 30=3.00W 40=4.00W 50=5.00W	D : $\pm 0.5\%$ F : $\pm 1.0\%$ G : $\pm 2.0\%$	2M50=2.5mR R005=5.0mR R020=020mR R150=150mR	M : MnCu C : Cu Alloy	



MFR Series Metal Foil Low-Resistance Resistor Product Specifications

Document No. S-10-12-07-07

Released Date 2022/04/11

Page No. 2/11

Standard Electrical Specifications

Type	Rating Power at 70°C	T.C.R. (ppm/°C)	Max. Rating Current	Max. Overload Current	Resistance Range (mΩ)			Material	Operating Temperature Range (°C)
					0.5% (D)	1.0% (F)	2.0%(G)		
MFR0603	0.5W	±75	10A	15.81A	—	5~9	—	R005~R050 : MnCu	-55°C~155°C
		±50	7.07A	11.18A	10~50		—		
MFR0805	0.75W	±75	13.69A	21.65A	—	4~9	—	R004~R049 : MnCu	
		±50	8.66A	13.69A	10~270		—	R050~R270 : Cu Alloy	
MFR1206	1W	±75	15.81A	25A	—	4~9	—	R004~R049 : MnCu	
		±50	10A	15.81A	10~700		—	R050~R700 : Cu Alloy	
MFR2010	1.5W	±100	27.38A	43.30A	—	2~9	—	R002~R500 : Cu Alloy	
		±50	12.24A	19.36A	10~500		—		
MFR2512	2W	±75	31.62A	50A	—	2~9	—	R002~R049 : MnCu	
		±50	14.14A	22.36A	10~560		—	R050~R560 : Cu Alloy	
MFR3921	4W	—	—	—	—	—	—	R010~R050 : Cu Alloy	
		±50	20A	31.62A	10~50		—		
MFR4527	5W	—	—	—	—	—	—	R010~R050 : Cu Alloy	
		±50	22.36A	35.35A	10~50		—		
MFR0508	1W	±100	31.62A	50A	—	—	1	R001~R009 : MnCu R010~R100 : Cu Alloy	
		±100	22.36A	35.35A	—	2~9	—		
		±50	10A	15.81A	10~100		—		
MFR0612	1.5W	±100	38.72A	61.23A	—	—	1	R001~R009 : MnCu R010~R100 : Cu Alloy	
		±100	27.38A	43.30A	—	2~9	—		
		±50	12.24A	19.36A	10~100		—		
MFR0815	2W	±100	44.72A	70.71A	—	—	1	R001~R020 : Cu Alloy	
		±100	31.62A	50A	—	2~9	—		
		±50	14.14A	22.36A	10~20		—		
MFR1225	3W	±100	54.77A	86.60A	—	1~9	—	R001~R020 : MnCu R021~R100 : Cu Alloy	
		±50	17.32A	27.38A	10~100		—		
MFR2139	5W	±100	70.71A	111.8A	—	1~9	—	R001~R020 : MnCu R021~R100 : Cu Alloy	
		±50	22.36A	35.35A	10~100		—		

■ Type Dimension

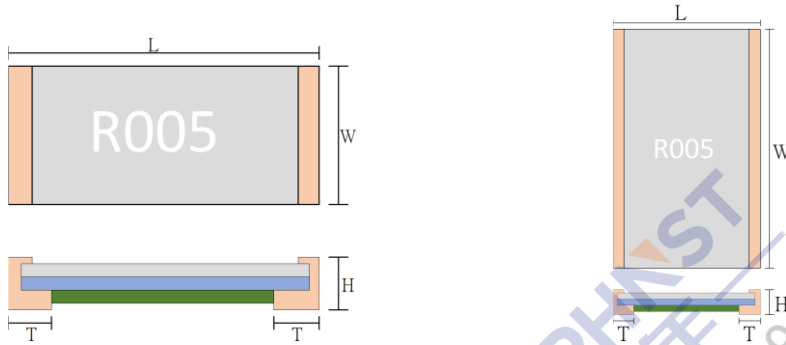

■ Dimension

Unit : mm

	Power Rating	Resistance Range	L	W	H	T
MFR0603	0.5W	5mΩ	1.60±0.25	0.80±0.25	0.65±0.20	0.50±0.20
		6~50mΩ				0.40±0.20
MFR0805	0.75W	4~270mΩ	2.00±0.25	1.20±0.25	0.65±0.20	0.50±0.20
MFR1206	1W	4~700mΩ	3.20±0.25	1.60±0.25	0.65±0.20	0.68±0.30
MFR2010	1.5W	2~3mΩ	5.08±0.25	2.54±0.25	0.65±0.20	2.10±0.30
		4~500mΩ				0.70±0.30
MFR2512	2W	2mΩ	6.40±0.30	3.20±0.30	0.75±0.20	1.65±0.30
		3mΩ				1.65±0.30
		4~560mΩ				1.05±0.30
MFR3921	4W	10~50mΩ	11.10±0.30	5.10±0.30	0.65±0.30	2.36±0.30
MFR4527	5W	10~50mΩ	11.60±1.0	7.10±1.0	0.65±0.30	2.70±0.40
MFR0508	1W	1~100mΩ	1.35±0.20	2.10±0.20	0.65±0.20	0.43±0.20
MFR0612	1.5W	1mΩ	1.60±0.25	3.20±0.25	0.65±0.20	0.50±0.30
		2~100mΩ				0.40±0.20
MFR0815	2W	1~20mΩ	2.20±0.20	3.80±0.20	0.65±0.20	0.61±0.20
MFR1225	3W	1~100mΩ	3.20±0.30	6.40±0.30	0.65±0.20	0.60±0.20
MFR2139	5W	1~100mΩ	5.10±0.40	11.10±0.30	0.65±0.30	0.90±0.30



MFR Series Metal Foil Low-Resistance Resistor Product Specifications

Document No. S-10-12-07-07

Released Date 2022/04/11

Page No. 4/11

■ Performance Characteristics

Power Derating Curve

The Operating Temperature Range: -55°C ~+155°C.

For resistors operated in ambient temperatures above 70°C, power rating must be derated in accordance with the curve below (Terminal temperature derating from above 100°C)

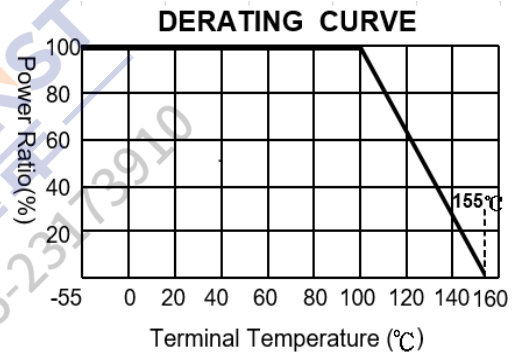
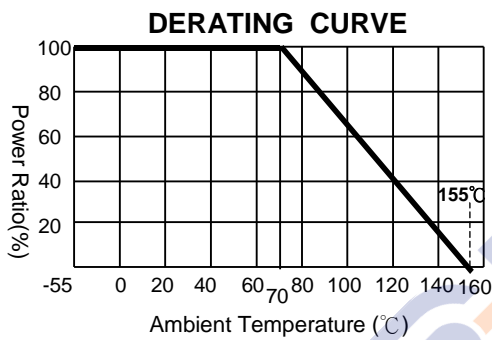

■ Rating Current

The following equation may be used to determine the DC (Direct Current) or AC (Alternating Current) (RMS, root mean square value) of normal rated power. However, if the result value exceeds the highest current of regulated standards (paragraph 5), the highest normal rated power is to be used

$$I = \sqrt{P/R}$$

I = Rating current (A)

P= Rating Power (W)

R= Resistance(Ω)



MFR Series Metal Foil Low-Resistance Resistor Product Specifications

Document No.	S-10-12-07-07
Released Date	2022/04/11
Page No.	5/11

■ Marking Format:

- 0603 type products marking are 2 or 3 digits
 - e.g. 2 digits
 - 10m Ω the product marking is 10.
 - 15m Ω the product marking is 15
 - e.g. 3 digits
 - "M" designates the decimal location in milli-ohms
 - 2.5m Ω the product marking is 2M5
- 0805 type products marking are 3 or 4 digits.
 - "R" designates the decimal location in ohms
 - e.g. 3 digits
 - 50m Ω the product marking is 050.
 - 500m Ω the product marking is 500.
 - e.g. 4 digits
 - 20m Ω the product marking is R020.
 - "M" designates the decimal location in milli-ohms
 - e.g. 5.5m Ω the product marking is 5M50.
- 1206 and above type products marking are 4 digits.
 - "R" designates the decimal location in ohms
 - e.g. 1m Ω the product marking is R001.
 - 20m Ω the product marking is R020.
 - "M" designates the decimal location in milli-ohms
 - e.g. 5.5m Ω the product marking is 5M50.
- The criteria to distinguishing the mark on the surface of products are that characters can be identified.



MFR Series Metal Foil Low-Resistance Resistor Product Specifications

Document No.	S-10-12-07-07
Released Date	2022/04/11
Page No.	6/11

■ Reliability Test and Requirement

Test Item	Test Method	Procedure	Requirements
Temperature Coefficient of Resistance (T.C.R)	JIS-C-5201-1 4.8 IEC-60115-1 4.8	At 25°C /+125°C, 25°C is the reference temperature	As Spec
Short Time Overload	JIS-C-5201-1 4.13 IEC-60115-1 4.13	The number of rated power are as follows: 2.5 times of rated power for 5 seconds.	±1.0%+0.5mΩ
High Temperature Exposure	JIS-C5201-1 4.25 IEC 60068-2-2	At 155°C for 1000 hours.	±1.0%+0.5mΩ
Low Temperature Storage	JIS-C-5201-1 4.23.4 IEC60115-1 4.23.4	At -55°C for 1000 hours	±1.0%+0.5mΩ
Resistance to Soldering Heat	JIS-C-5201-1 4.18 IEC-60115-1 4.18	260±5°C for 10 seconds.	±1.0%+0.5mΩ
Damp Heat with Load	JIS-C-5201-1 4.24 IEC-60115-1 4.24	40±2°C, 90~95% R.H. RCWV or Max. working voltage whichever is less for 1000 hrs with 1.5 hrs "ON" and 0.5 hr "OFF" .	±2.0%+0.5mΩ
Rapid Change of Temperature	JIS-C-5201-1 4.19 IEC-60115-1 4.19	-55°C to +155°C, 100 cycles	±1.0%+0.5mΩ
Load Life (Endurance)	JIS-C-5201-1 4.25 IEC-60115-1 4.25.1	70±2 °C , RCWV or Max. working voltage whichever is less for 1000 hrs with 1.5 hrs "ON" and 0.5 hr "OFF" .	±2.0%+0.5mΩ
Solderability	JIS-C-5201-1 4.17 IEC-60115-1 4.17	245±5°C for 3 seconds.	The covered area >95%
Mechanical Shock	JIS C 5202 6.7	a =50G , t =11ms, 5 times shock	±1.0%+0.5mΩ
Bending Strength	JIS-C-5201-1 4.33 IEC-60115-1 4.33	Bending once 2mm for 10 seconds	±1.0%+0.5mΩ



MFR Series Metal Foil Low-Resistance Resistor Product Specifications

Document No.	S-10-12-07-07
Released Date	2022/04/11
Page No.	7/11

● Recommended Customer Soldering Parameters

■ Wave solder Temperature condition

Preheating : 100°C~130°C, max.100 sec.

Soldering: 250°C~265°C max. 10 sec.

Maximum temperature : 260±5°C, max. 10sec.

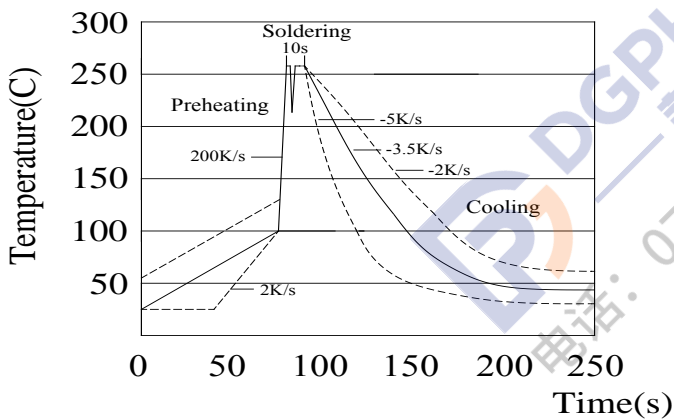

■ Solder reflow Temperature condition

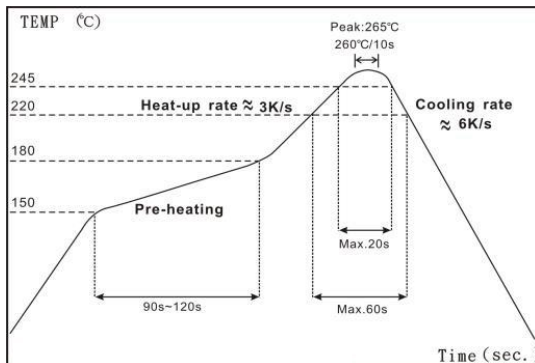

■ Rework temperature (hot air equipment) : 350°C , 3~5seconds

■ Recommended reflow methods

IR, vapor phase oven, hot air oven

If reflow temperatures exceed the recommended profile, devices may not meet the performance requirements.



MFR Series Metal Foil Low-Resistance Resistor Product Specifications

Document No.	S-10-12-07-07
Released Date	2022/04/11
Page No.	8/11

Recommend Land Pattern Design

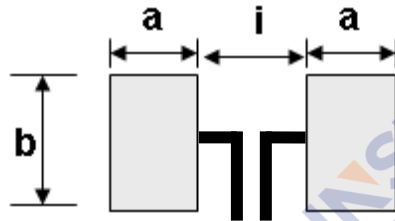

Dimension

Unit: mm

TYPE	Resistance Range	a	b	i
MFR0603 – 0.5W	5mΩ	1.35	0.92	0.50
	6mΩ~50mΩ	1.30	0.92	0.60
MFR0805 – 0.75W	4mΩ~270mΩ	1.40	1.44	0.80
MFR1206 – 1W	4mΩ~700mΩ	1.80	1.84	1.20
MFR2010– 1.5W	2~3mΩ	3.65	2.88	0.70
	4mΩ~500mΩ	2.65	2.88	2.70
MFR2512 – 2W	2~3mΩ	3.85	3.57	1.6
	4~560mΩ	3.10	3.57	3.10
MFR3921 – 4W	10mΩ~50mΩ	4.50	5.75	5.00
MFR4527 – 5W	10mΩ~50mΩ	4.65	8.05	5.20



MFR Series Metal Foil Low-Resistance Resistor Product Specifications

Document No. S-10-12-07-07

Released Date 2022/04/11

Page No. 9/11

Dimension

Unit: mm

TYPE	Resistance Range	a	b	l
MFR0508 – 1W	1~100mΩ	1.10	2.30	0.60
MFR0612 – 1.5W	1mΩ	1.35	3.68	0.50
	2~100mΩ	1.30	3.68	0.60
MFR0815 – 2W	1~20mΩ	2.40	4.26	0.70
MFR1225 – 3W	1~100mΩ	2.35	7.25	1.40
MFR2139 – 5W	1~100mΩ	2.80	12.65	2.40

Packing Quantity

TYPE	PCS /Reel
MFR0603	5000
MFR0805 / MFR0508	5000
MFR1206 / MFR0612	5000
MFR2010	4000
MFR2512 / MFR1225	4000
MFR0815	4000
MFR3921/ MFR2139	2000
MFR4527	1000



MFR Series Metal Foil Low-Resistance Resistor Product Specifications

Document No.	S-10-12-07-07
Released Date	2022/04/11
Page No.	10/11

Appendix For SMD Chip Resistor

● Packaging Information

■ Reel Dimensions

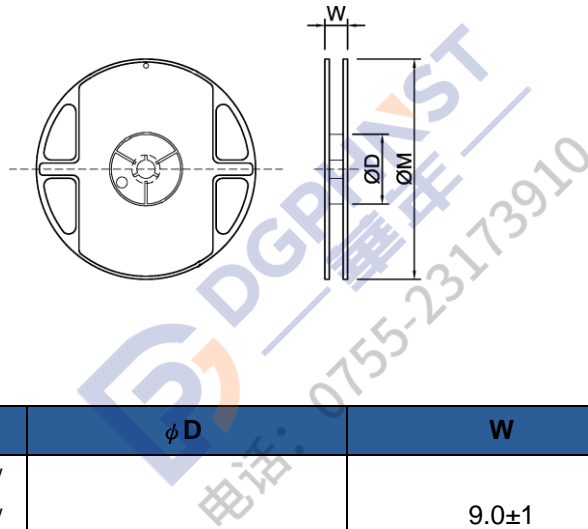

■ Dimension

Unit: mm

TYPE	ϕD	W	ϕM
MFR0603 / MFR0805 / MFR1206 / MFR0508 / MFR0612	60±2	9.0±1	178±5
MFR2010 / MFR2512 / MFR0815 / MFR1225		13±1	
MFR3921 / MFR4527 / MFR2139		24.5±1	

■ Carrier Dimensions

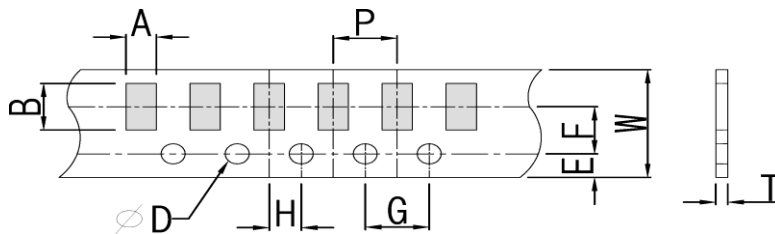

■ Dimension

Unit: mm

Item	W	P	E	F	ϕD	G	H	A	Bo	T	
MFR0603	8.0±0.30	4.0±0.10	1.75±0.10	3.5±0.10	1.50 ^{+0.1} ₀	4.0±0.10	2.0±0.10	1.18±0.20	1.98±0.20	0.75±0.20	
MFR0805								1.68±0.20	2.38±0.20	0.87±0.20	
MFR1206								2.05±0.20	3.65±0.20	0.87±0.10	
MFR0508											
MFR0612											



MFR Series Metal Foil Low-Resistance Resistor Product Specifications

Document No.	S-10-12-07-07
Released Date	2022/04/11
Page No.	11/11

■ Embossed Dimensions

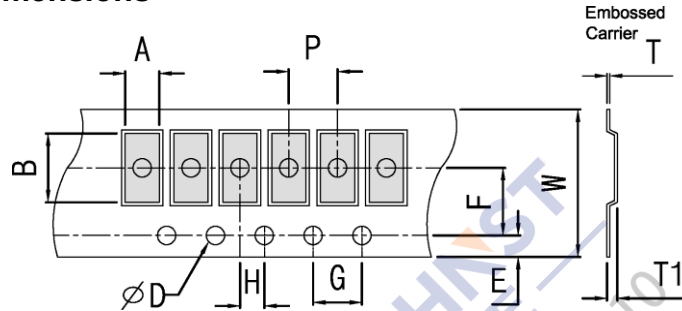

■ Dimension

Unit: mm

Item	W	P	E	F	ϕD	G	H	A	B	T1	T
MFR1508	12.0±0.40	4.0±0.10	1.75±0.10	5.5±0.10	1.50 ^{+0.1} ₋₀	4.0±0.10	2.0±0.10	2.40±0.20	4.10±0.20	0.75±0.20	0.25±0.10
MFR2010	12.0±0.30	4.0±0.10	1.75±0.10	5.5±0.10		4.0±0.10	2.0±0.10	2.85±0.20	5.45±0.20	0.80±0.20	0.25±0.10
MFR2512	12.0±0.30	4.0±0.10	1.75±0.10	5.5±0.10		4.0±0.10	2.0±0.10	3.40±0.20	6.75±0.20	1.00±0.20	0.25±0.10
MFR1225											
MFR3921	24.0±0.30	8.0±0.10	1.75±0.10	11.5±0.10		4.0±0.10	2.0±0.10	5.50±0.20	11.5±0.20	0.90±0.20	0.30±0.10
MFR2139											
MFR4527	24.0±0.30	12.0±0.10	1.75±0.10	11.5±0.10		4.0±0.10	2.0±0.10	7.50±0.20	12.0±0.20	0.90±0.20	0.30±0.10

■ Peeling Strength of Seal Tape

Peeling Strength: 0.1 – 1.0N (10 - 100gf)

■ Storage Temperature

Temperature : 25±5°C, Humidity : 60±20%