

Surface Mount Polymeric ESD Suppressor

PE0603S12G21R

Description

This specification is applied to electrostatic discharge (ESD) protection. It is designed to protect the high-speed data lines against ESD transients. It has very low capacitance and fast turn on times makes it ideal for data and transmission lines with high data rates.

According to the special property of device, we recommend not to use on such application as: DC/AC power line.

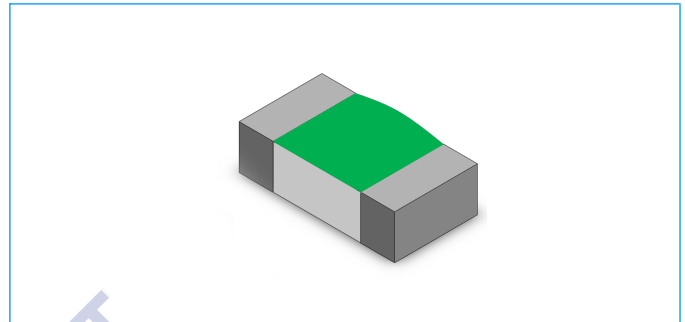

Features

- u Protection against ESD voltages and currents (IEC61000-4-2 Level 4)
- u Extremely quick response time (<1ns) present ideal ESD protection
- u Extremely low capacitance (0.2pF typical)
- u Extremely low leakage current
- u Bi-directional device
- u SMD (Surface Mount Device)
- u Zero signal distortion
- u For RoHS Compliance

Equivalent Circuit

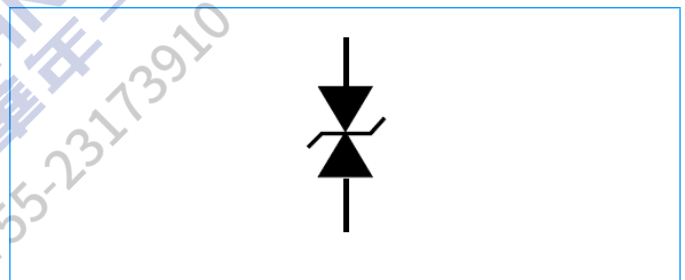

Applications

- u Antenna circuit
- u USB2.0 / USB3.0
- u IEEE-1394
- u DVI
- u HDMI

Product Model

- u Digital Video Equipment
- u Mobil Phone
- u GPS Antenna
- u Bluetooth Communication Equipment

Electrical Characteristics

Parameter	Symbol	Min.	Typ.	Max.	Unit
Rated voltage	V_{DC}	--	--	12	V
Leakage current	I_L	--	0.01	--	μA
Peak voltage	V_P	--	300	--	V
Trigger voltage	V_t	--	300	--	V
Clamping voltage	V_C	--	30	--	V
Capacitance,@1MHz	C_P	--	0.2	--	pF
Response time	--	--	--	1	ns
ESD voltage capability,Contact discharge mode	--	--	8	--	kV
ESD voltage capability,Air discharge mode	--	--	15	--	kV
ESD pulse withstand	--	--	1000	--	pulses

Rated voltage – I_L measurement rated voltage.

V_P – The peak voltage value shall be measured under the following conditions. ESD test conditions : IEC61000-4-2, 8 kV contact discharge.

V_t – measurement by using Transmission Line Pulse (TLP).

V_C – measurement by using Transmission Line Pulse (TLP).

C_P – Device capacitance measured with 1Vrms.

Surface Mount Polymeric ESD Suppressor

PE0603S12G21R

General Specifications

Temperature Specifications

Operating Temperature Range: -40°C to +85°C

Storage Temperature Range: -40°C to +85°C

Environmental Specifications

Item	Specifications	Test Condition	Reference
Bias Humidity	$I_L \leq 10 \mu A$	90%RH, 40°C, Rated Voltage, 1000hrs	MIL-STD-202,Method 103
Thermal Shock	$I_L \leq 10 \mu A$	-40°C to 85°C, 30 min. cycle, 5 cycles	JIS C 0025 (1998),Test Na
High Temperature Load Voltage	$I_L \leq 10 \mu A$	Rated voltage , 85°C, 1000 hrs	MIL-STD-202G,Method 108
Solder Leach Resistance	$I_L \leq 10 \mu A$	260°C, 10s	MIL-STD-202G,Method 210F
Vibration	$I_L \leq 10 \mu A$	The entire frequency range:10~55Hz 1.5mm amplitude; 2 hours for each of X, Y, Z directions	MIL-STD-202G,Method 201A

I_L – Leakage current at rated voltage, the maximum leakage current was measured after reliability test.

Precautions for Handling

Solder Cream in Reflow Soldering

Refer to the recommendable land pattern as printing mask pattern for solder cream. Print solder in a thickness of 0.15 to 0.20 mm.

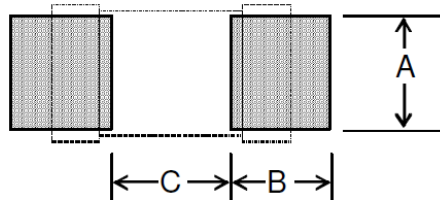

Symbol	Unit: mm(inch)
A	0.75±0.1 (0.03±0.004)
B	0.75±0.1 (0.03±0.004)
C	0.75±0.1 (0.03±0.004)

Precaution for Handling of Substrate

Do not exceed to bend the board after soldering this product extremely. (reference examples)

- Mounting place must be as far as possible from the position, which is close to the break line of board, or on the line of large holes of board.
- Do not bend extremely the board, in mounting another components. If necessary, use back-up pin (support pin) to prevent from bending extremely.
- Do not break the board by hand. We recommend to use the machine or the jig to break it.

Precaution for Soldering

Note that this product will be easily damaged by rapid heating, rapid cooling or local heating.

Do not give heat shock over 100°C in the process of soldering. We recommend to take preheating and gradual cooling.

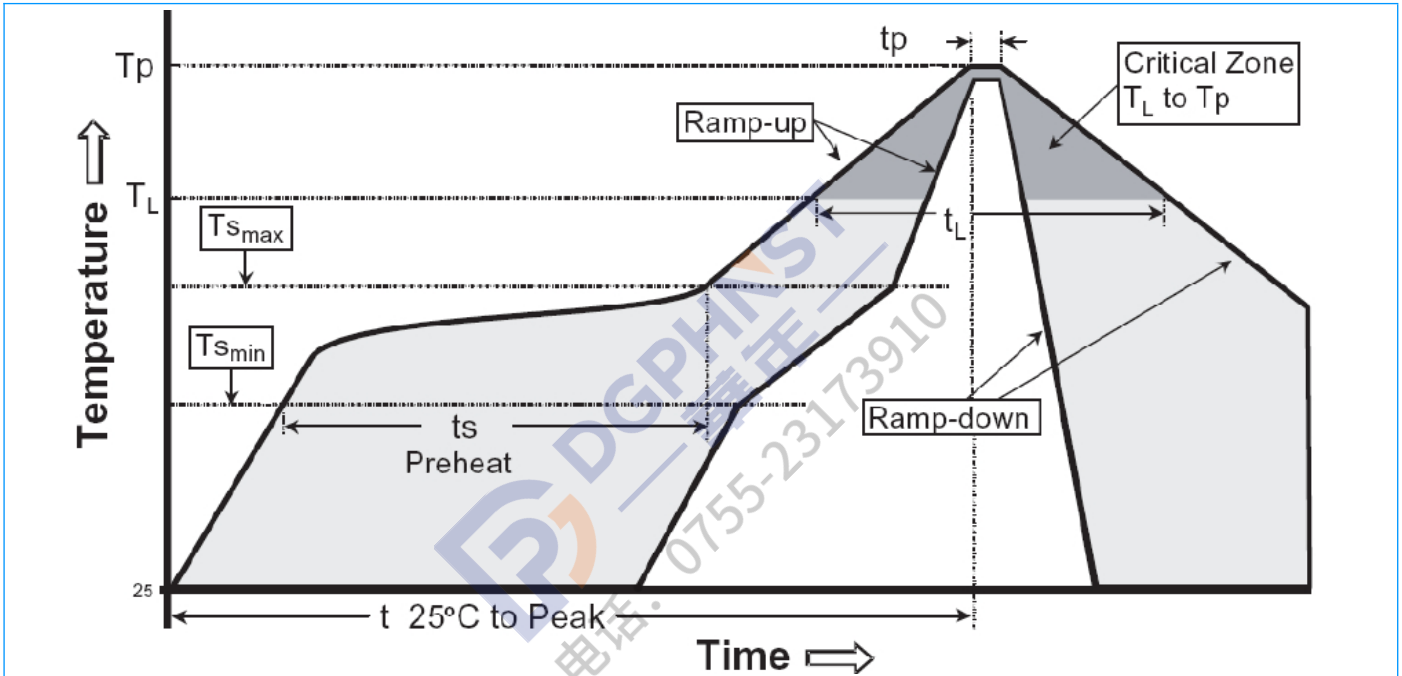
Surface Mount Polymeric ESD Suppressor
PE0603S12G21R
Precautions for Handling (Continue)
U Recommendable Reflow Soldering

Profile Feature	Pb free Assembly
Average Ramp Rate (T_s max to T_p)	3 °C/second max
Preheat	
- Temperature Min ($T_{s_{min}}$)	150 °C
- Temperature Min ($T_{s_{max}}$)	200 °C
- Time($t_{s_{min}}$ to $t_{s_{min}}$)	60-180 seconds
Time maintained above:	
- Temperature (T_L)	217 °C
- Time (t_L)	60-150 seconds
Peak Temperature (T_p)	260 °C +0/-5 °C
Time within 5 °C of actual Peak Temperature (T_p)	20-40 seconds
Ramp-Down Rate	6 °C/second max.
Time 25 °C to Peak Temperature	8 minutes max

Surface Mount Polymeric ESD Suppressor

PE0603S12G21R

Precautions for Handling (Continue)

⊍ Soldering Gun Procedure

Note the follows, in case of using solder gun for replacement.

- (1) The tip temperature must be less than 280°C for the period within 3 seconds by using soldering gun under 30 W.
- (2) The soldering gun tip shall not touch this product directly.

⊍ Soldering Volume

Note that excess of soldering volume will easily get crack the body of this product.

⊍ Taping Package Storage Condition

Storage Temperature: 5 °C to 40 °C

Relative Humidity: < 65%RH

Storage Time: 12 months max

Construction & Dimensions

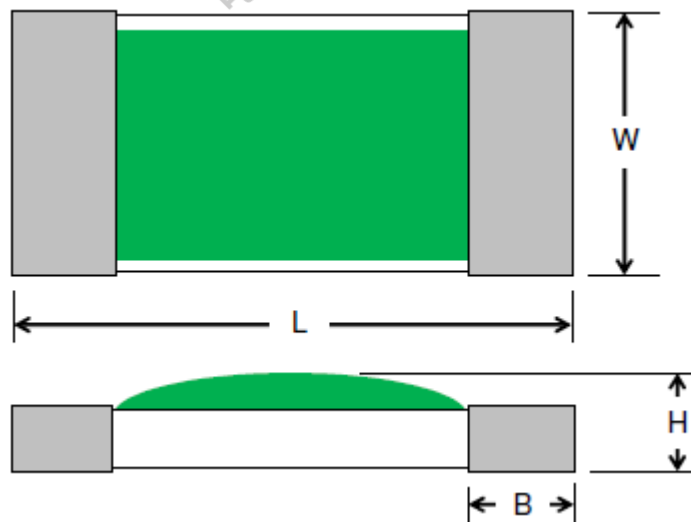

Size EIA	0603			
Symbol	L	W	H	B
Unit: mm	1.60±0.10	0.85±0.15	0.51±0.05	0.30±0.20

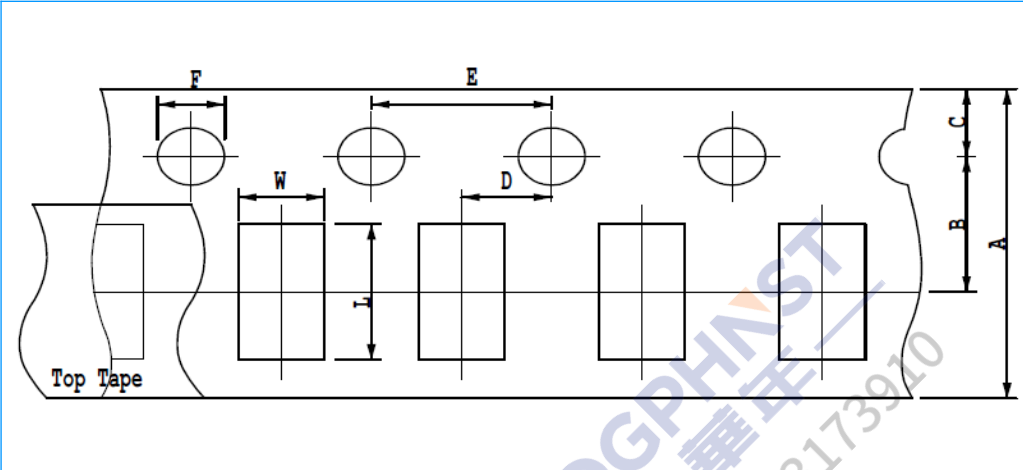
Surface Mount Polymeric ESD Suppressor
PE0603S12G21R
Carrier Tape Dimensions

Symbol	0603 (Unit: mm)
A	8.00±0.30
B	3.50±0.05
C	1.75±0.10
D	2.00±0.05
E	4.00±0.10
F	1.50±0.10
L	1.90±0.20
W	1.05±0.20

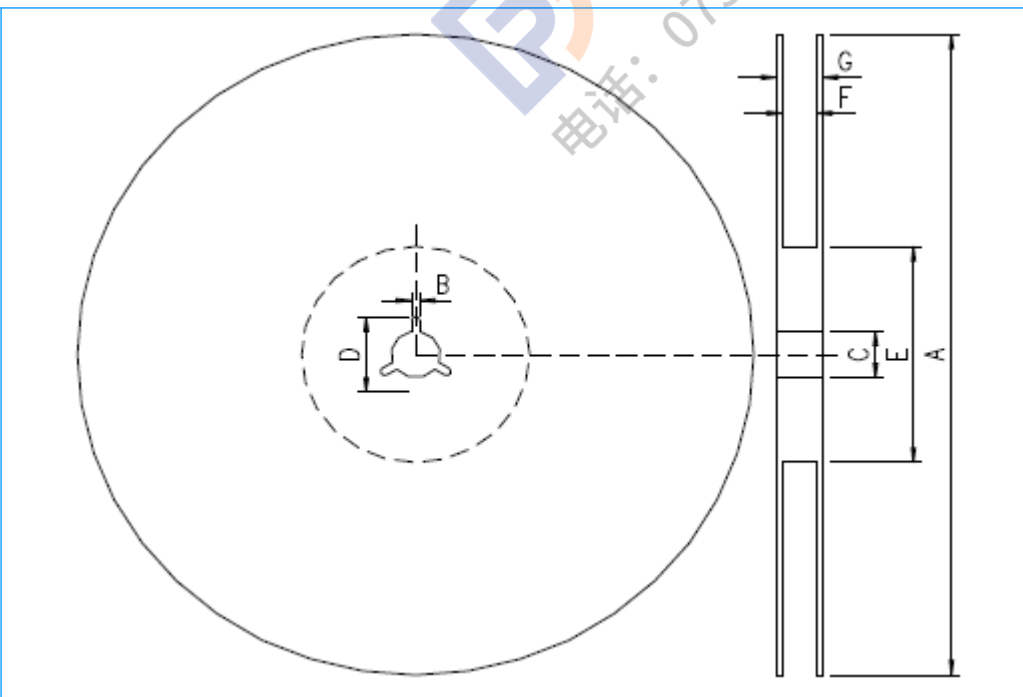
Carrier Tape Dimensions

Symbol	0603 (Unit: mm)
A	178.0±2.0
B	2.0±0.5
C	13.0±0.5
D	21.0±0.8
E	62.0±1.5
F	9.0±0.5
G	13.0±1.0

Standard Packaging

Size EIA	Quantity
0603	5000 PCS / REEL