

SOT-223(8R) Plastic-Encapsulate Transistors

PZTA92 TRANSISTOR (PNP)

FEATURES

- High Voltage Driver Applications

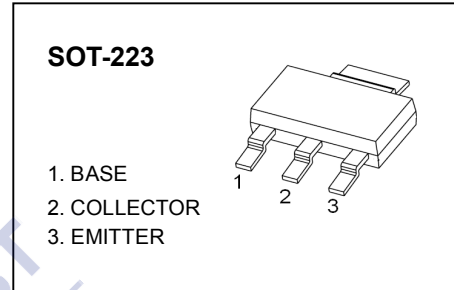

MARKING:



Equivalent Circuit

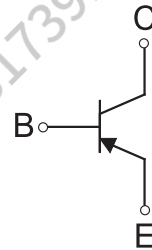

MAXIMUM RATINGS ($T_a=25^\circ\text{C}$ unless otherwise noted)

Symbol	Parameter	Value	Unit
V_{CBO}	Collector-Base Voltage	-300	V
V_{CEO}	Collector-Emitter Voltage	-300	V
V_{EBO}	Emitter-Base Voltage	-5	V
I_C	Collector Current -Continuous	-0.2	A
I_{CM}	Collector Current- Pulsed	-0.5	A
P_C	Collector Power Dissipation	1	W
$R_{\theta JA}$	Thermal Resistance from Junction to Ambient	125	$^\circ\text{C}/\text{W}$
T_J, T_{stg}	Operation Junction and Storage Temperature Range	-55~150	$^\circ\text{C}$

ELECTRICAL CHARACTERISTICS ($T_a=25^\circ\text{C}$ unless otherwise specified)

Parameter	Symbol	Test conditions	Min	Typ	Max	Unit
Collector-base breakdown voltage	$V_{(BR)CBO}$	$I_C=-0.1\text{mA}, I_E=0$	-300			V
Collector-emitter breakdown voltage	$V_{(BR)CEO}$	$I_C=-1\text{mA}, I_B=0$	-300			V
Emitter-base breakdown voltage	$V_{(BR)EBO}$	$I_E=-0.1\text{mA}, I_C=0$	-5			V
Collector cut-off current	I_{CBO}	$V_{CB}=-200\text{V}, I_E=0$			-250	nA
Emitter cut-off current	I_{EBO}	$V_{EB}=-3\text{V}, I_C=0$			-100	nA
DC current gain	$h_{FE(1)}$	$V_{CE}=-10\text{V}, I_C=-1\text{mA}$	25			
	$h_{FE(2)}$	$V_{CE}=-10\text{V}, I_C=-10\text{mA}$	40			
	$h_{FE(3)}$	$V_{CE}=-10\text{V}, I_C=-30\text{mA}$	25			
Collector-emitter saturation voltage	$V_{CE(sat)}$	$I_C=-20\text{mA}, I_B=-2\text{mA}$			-0.5	V
Base-emitter saturation voltage	$V_{BE(sat)}$	$I_C=-20\text{mA}, I_B=-2\text{mA}$			-0.9	V
Transition frequency	f_T	$V_{CE}=-20\text{V}, I_C=-10\text{mA}, f=100\text{MHz}$	50			MHz
Collector output capacitance	C_{ob}	$V_{CB}=-20\text{V}, I_E=0, f=1\text{MHz}$			6	pF

Typical Characteristics

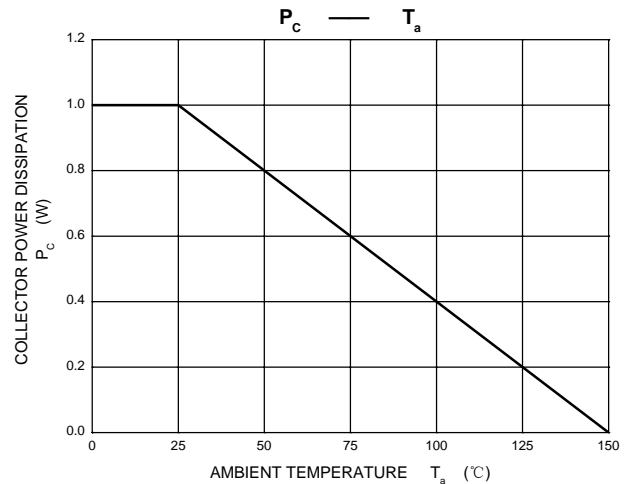
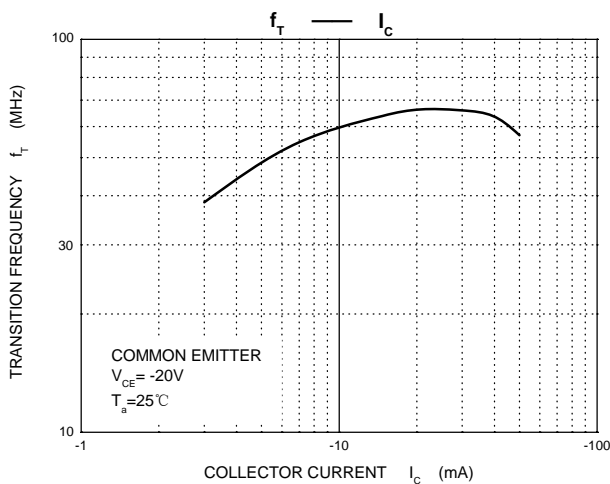
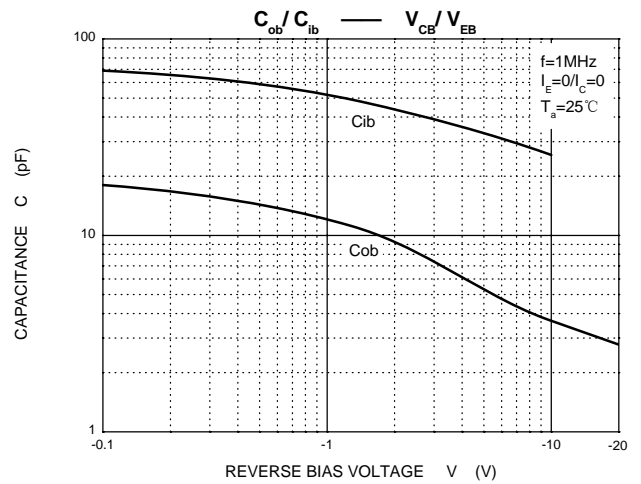
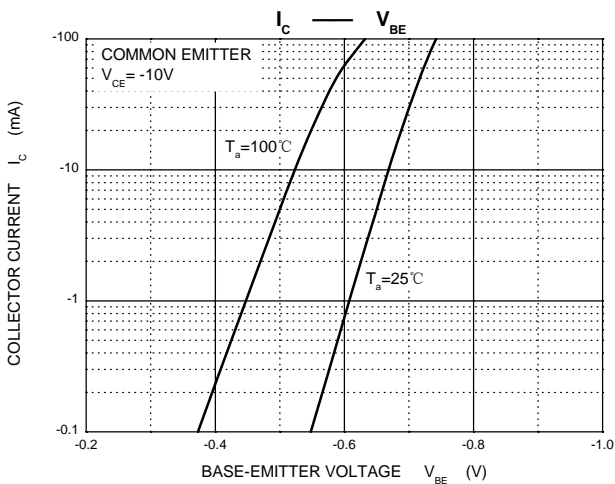
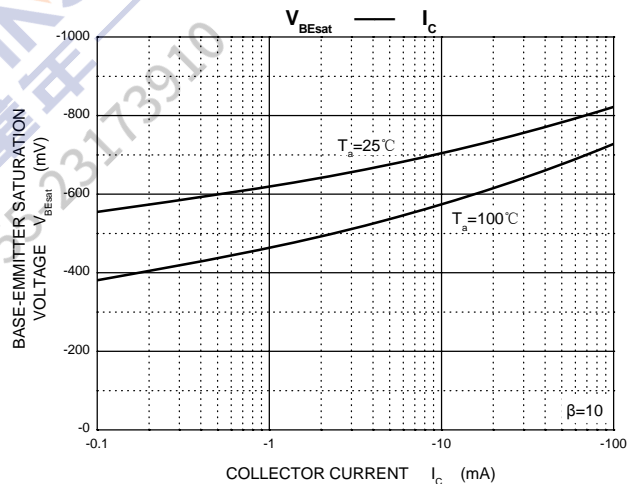
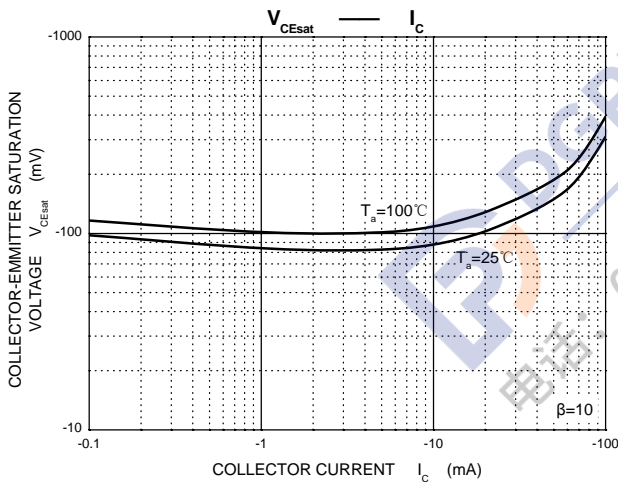
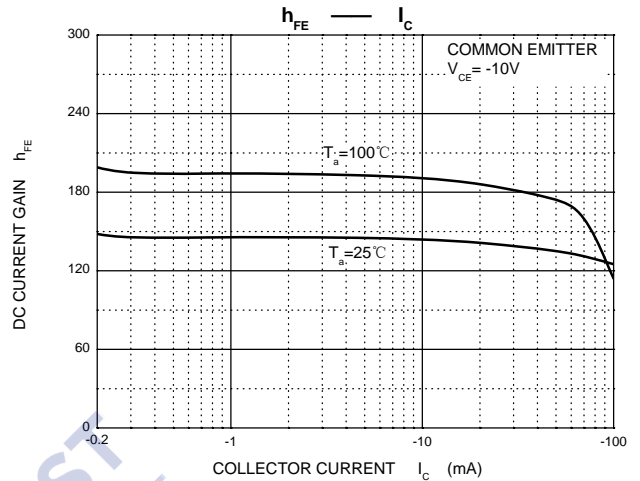
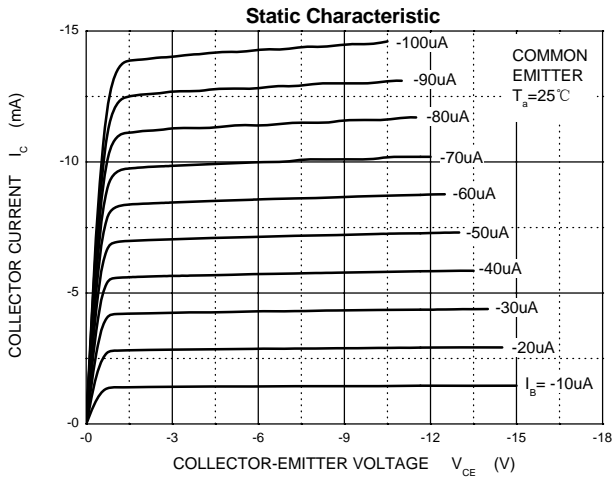

SOT-223 Package Outline Dimensions

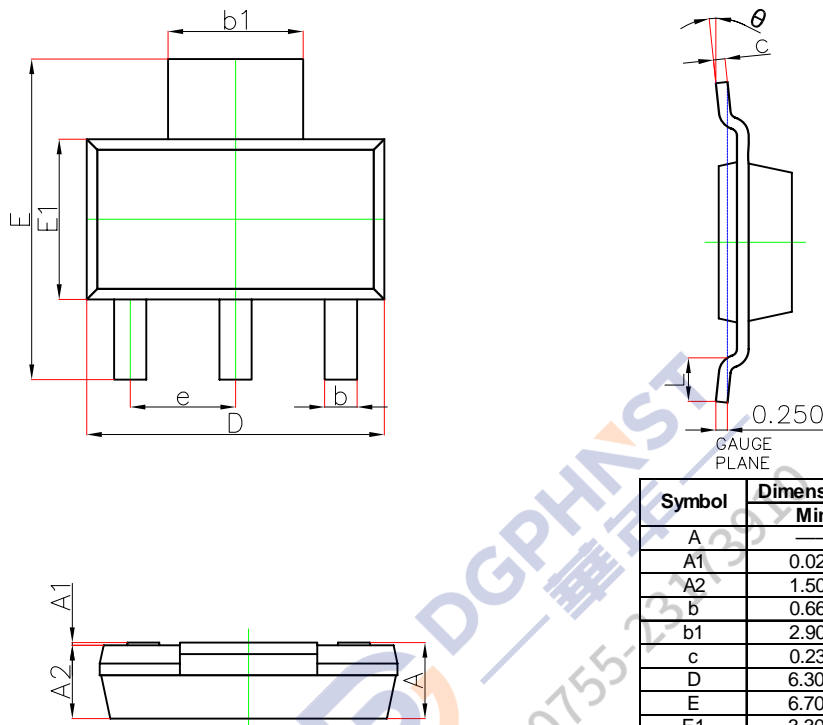

Symbol	Dimensions In Millimeters		Dimensions In Inches	
	Min.	Max.	Min.	Max.
A	—	1.800	—	0.071
A1	0.020	0.100	0.001	0.004
A2	1.500	1.700	0.059	0.067
b	0.660	0.840	0.026	0.033
b1	2.900	3.100	0.114	0.122
c	0.230	0.350	0.009	0.014
D	6.300	6.700	0.248	0.264
E	6.700	7.300	0.264	0.287
E1	3.300	3.700	0.130	0.146
e	2.300(BSC)		0.091(BSC)	
L	0.750	—	0.030	—
θ	0°	10°	0°	10°

SOT-223 Suggested Pad Layout

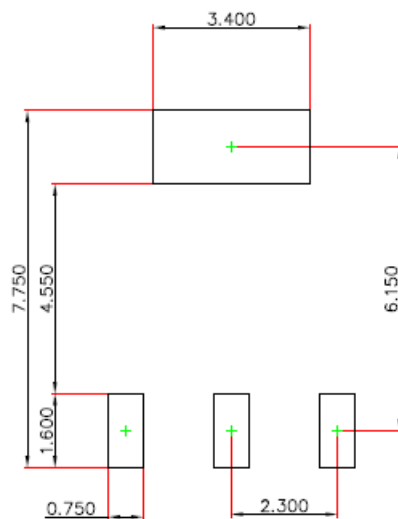

Note:

1. Controlling dimension: in millimeters.
2. General tolerance: $\pm 0.050\text{mm}$.
3. The pad layout is for reference purposes only.

NOTICE

JSCJ reserves the right to make modifications, enhancements, improvements, corrections or other changes without further notice to any product herein. JSCJ does not assume any liability arising out of the application or use of any product described herein.

SOT-223 Tape and Reel

SOT-223 Embossed Carrier Tape



Packaging Description:

SOT-223 parts are shipped in tape. The carrier tape is made from a dissipative (carbon filled) polycarbonate resin. The cover tape is a multilayer film (Heat Activated Adhesive in nature) primarily composed of polyester film, adhesive layer, sealant, and anti-static sprayed agent. These reeled parts in standard option are shipped with 2,500 units per 13" or 33.0cm diameter reel. The reels are clear in color and is made of polystyrene plastic (anti-static coated).

Dimensions are in millimeter											
Pkg type	A	B	C	d	E	F	P0	P	P1	W	
SOT-223	6.765	7.335	1.88	Ø1.50	1.75	5.50	4.00	8.00	2.00	12.00	

SOT-223 Tape Leader and Trailer

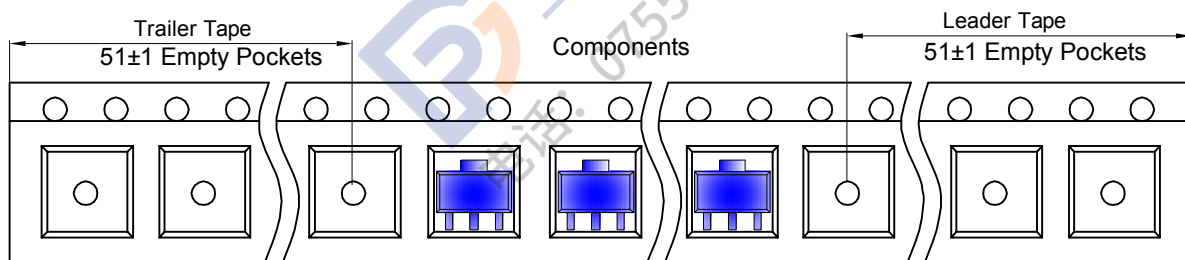

SOT-223 Reel

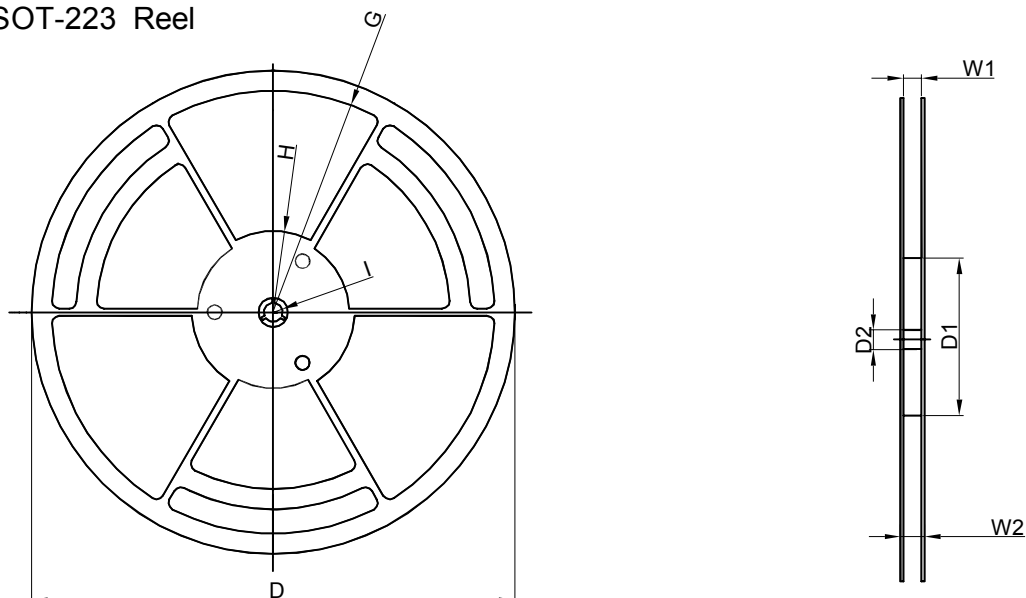

Dimensions are in millimeter									
Reel Option	D	D1	D2	G	H	I	W1	W2	
13" Dia	Ø330.00	100.00	13.00	R151.00	R56.00	R6.50	12.40	17.60	

REEL	Reel Size	Box	Box Size(mm)	Carton	Carton Size(mm)	G.W.(kg)
2,500 pcs	13 inch	2,500 pcs	336×336×48	20,000 pcs	445×355×365	