

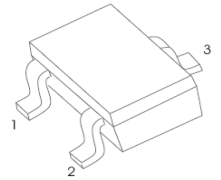

SOT-523 Plastic-Encapsulate Diodes

BAS70T/-04T/-05T/06T SCHOTTKY BARRIER DIODE

SOT-523



FEATURES

- Low Turn-on Voltage
- Fast Switching

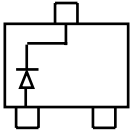

BAS70T Marking: 7C

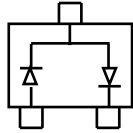

BAS70-04T Marking: 7D

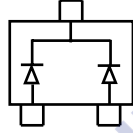

BAS70-05T Marking: 7E

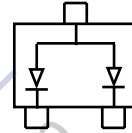

BAS70-06T Marking: 7F

MARKING:

BAS70H	BAS70-04H	BAS70-05H	BAS70-06H

Maximum Ratings @Ta=25°C

Parameter	Symbol	Limit	Unit
Peak Repetitive Peak Reverse Voltage	V_{RRM}	70	V
Working Peak Reverse Voltage	V_{RWM}		
DC Blocking Voltage	V_R		
Forward Continuous Current	I_{FM}	70	mA
Non-Repetitive Peak Forward Surge Current @ t = 8.3ms	I_{FSM}	100	mA
Power Dissipation	P_D	150	mW
Thermal Resistance Junction to Ambient	$R_{\theta JA}$	667	°C/W
Operating Junction Temperature Range	T_J	-40 ~ +125	°C
Storage Temperature Range	T_{STG}	-55 ~ +150	°C

ELECTRICAL CHARACTERISTICS (Ta=25°C unless otherwise specified)

Parameter	Symbol	Test conditions	Min	Max	Unit
Reverse breakdown voltage	$V_{(BR)}$	$I_R=10\mu A$	70		V
Reverse voltage leakage current	I_R	$V_R=50V$		100	nA
Forward voltage	V_F	$I_F=1mA$ $I_F=15mA$		410 1000	mV
Diode capacitance	C_D	$V_R=0, f=1MHz$		2	pF
Reveres recovery time	t_{rr}	$I_F=I_R=10mA, I_{rr}=0.1 \times I_R$ $R_L=100 \Omega$		5	ns

Typical Characteristics

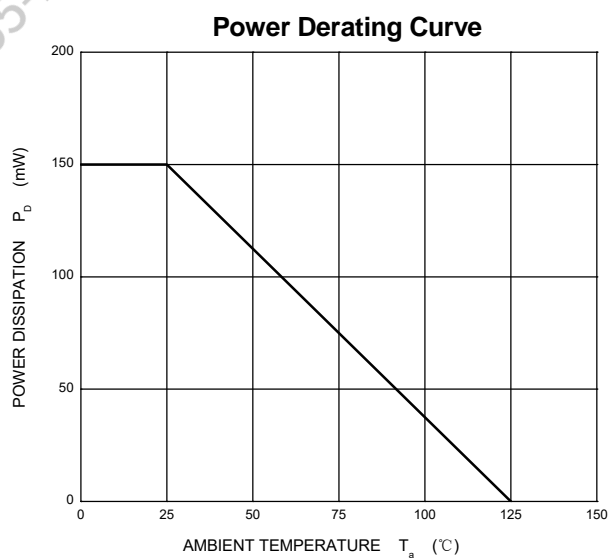
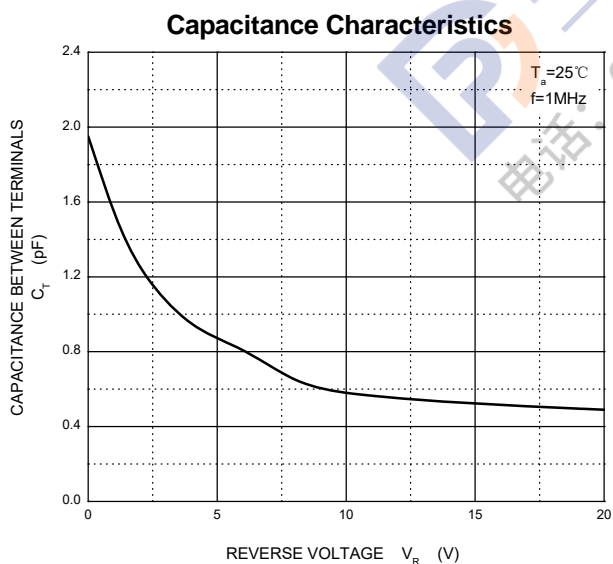
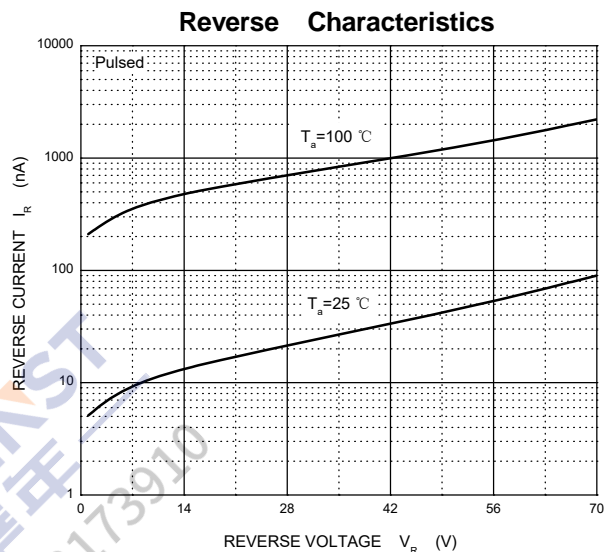
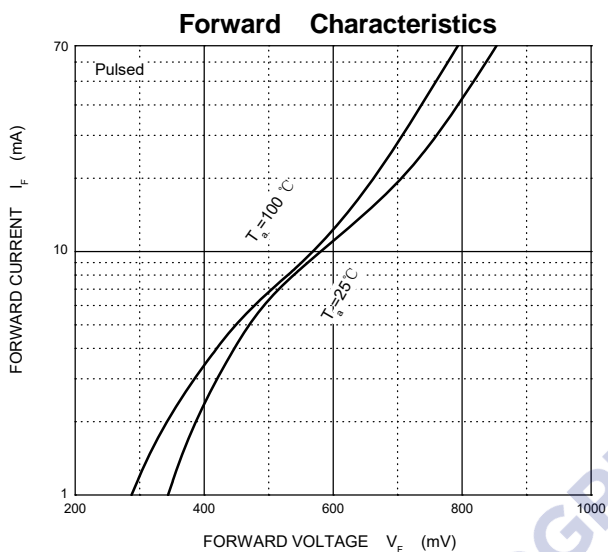

SOT-523 Package Outline Dimensions

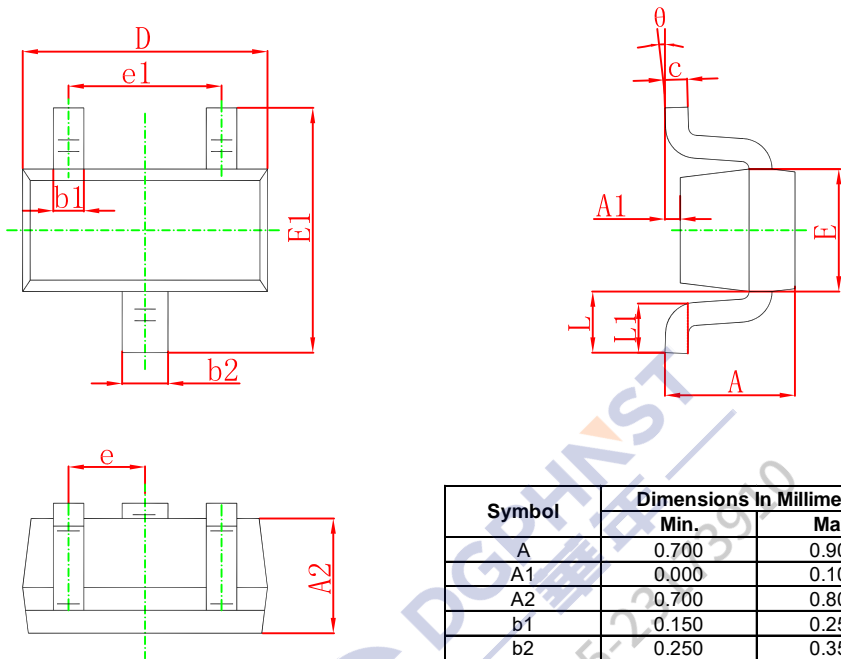

Symbol	Dimensions In Millimeters		Dimensions In Inches	
	Min.	Max.	Min.	Max.
A	0.700	0.900	0.028	0.035
A1	0.000	0.100	0.000	0.004
A2	0.700	0.800	0.028	0.031
b1	0.150	0.250	0.006	0.010
b2	0.250	0.350	0.010	0.014
c	0.100	0.200	0.004	0.008
D	1.500	1.700	0.059	0.067
E	0.700	0.900	0.028	0.035
E1	1.450	1.750	0.057	0.069
e	0.500 TYP.		0.020 TYP.	
e1	0.900	1.100	0.035	0.043
L	0.400 REF.		0.016 REF.	
L1	0.260	0.460	0.010	0.018
θ	0°	8°	0°	8°

SOT-523 Suggested Pad Layout

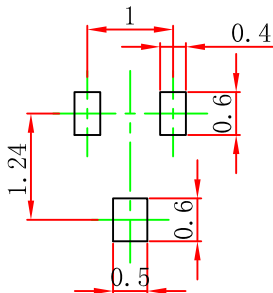

- Note:
1. Controlling dimension: in millimeters.
 2. General tolerance: $\pm 0.05\text{mm}$.
 3. The pad layout is for reference purposes only.

NOTICE

JSCJ reserves the right to make modifications, enhancements, improvements, corrections or other changes without further notice to any product herein. JSCJ does not assume any liability arising out of the application or use of any product described herein.

SOT-523 Tape and Reel

SOT-523 Embossed Carrier Tape

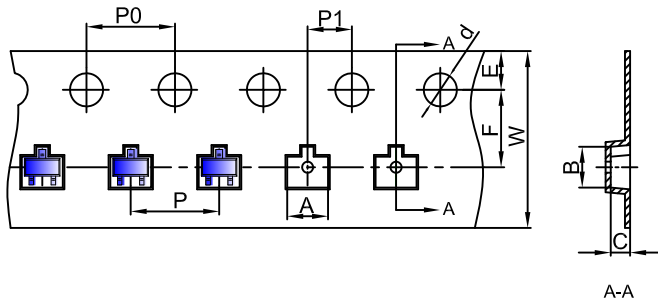

Packaging Description:

SOT-523 parts are shipped in tape. The carrier tape is made from a dissipative (carbon filled) polycarbonate resin. The cover tape is a multilayer film (Heat Activated Adhesive in nature) primarily composed of polyester film, adhesive layer, sealant, and anti-static sprayed agent. These reeled parts in standard option are shipped with 3,000 units per 7" or 17.8cm diameter reel. The reels are clear in color and is made of polystyrene plastic (anti-static coated).

Dimensions are in millimeter

Pkg type	A	B	C	d	E	F	P0	P	P1	W
SOT-523	1.85	1.85	0.875	Ø1.50	1.75	3.50	4.00	4.00	2.00	8.00

SOT-523 Tape Leader and Trailer

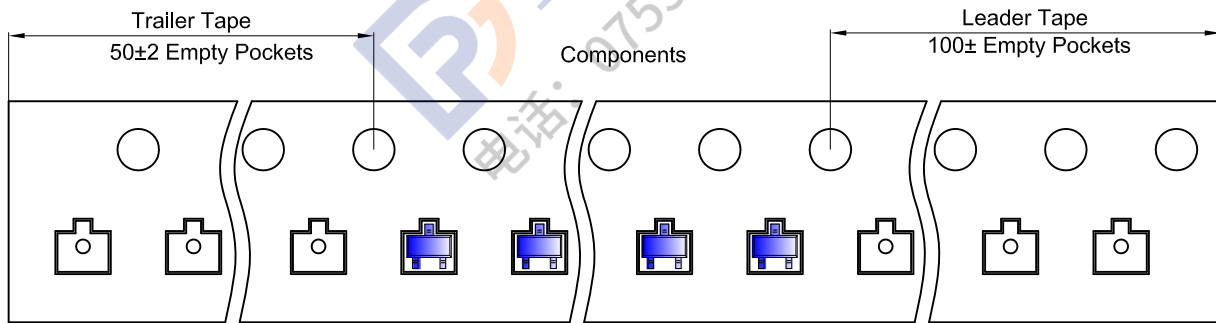

SOT-523 Reel

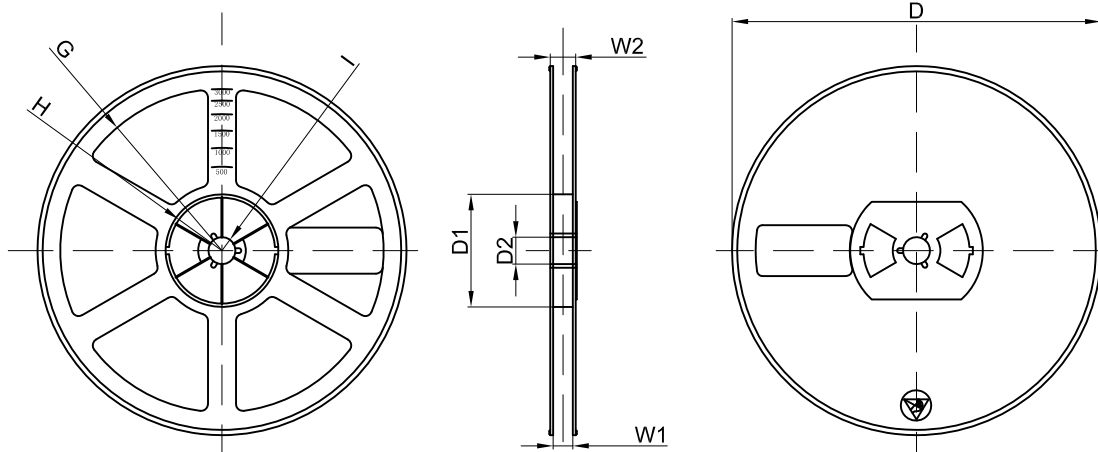

Dimensions are in millimeter

Reel Option	D	D1	D2	G	H	I	W1	W2
7" Dia	Ø178.00	54.40	13.00	R78.00	R25.60	R6.50	9.50	12.30

REEL	Reel Size	Box	Box Size(mm)	Carton	Carton Size(mm)	G.W.(kg)
3000 pcs	7 inch	45,000 pcs	203×203×195	180,000 pcs	438×438×220	