

SOT-523 Plastic-Encapsulate Transistors

MMBT3904T TRANSISTOR (NPN)

FEATURES

- Complementary to MMBT3906T
- Small Package

MARKING:

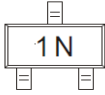

1N = Device code

SOT - 523

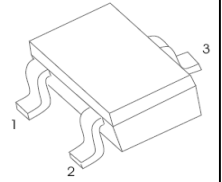

1. BASE
2. EMITTER
3. COLLECTOR

MAXIMUM RATINGS ($T_a=25^\circ\text{C}$ unless otherwise noted)

Symbol	Parameter	Value	Unit
V_{CBO}	Collector-Base Voltage	60	V
V_{CEO}	Collector-Emitter Voltage	40	V
V_{EBO}	Emitter-Base Voltage	6	V
I_C	Collector Current	200	mA
P_C	Collector Power Dissipation	150	mW
$R_{\theta JA}$	Thermal Resistance From Junction To Ambient	833	$^\circ\text{C}/\text{W}$
T_J, T_{stg}	Operation Junction and Storage Temperature Range	-55~+150	$^\circ\text{C}$

ELECTRICAL CHARACTERISTICS ($T_a=25^\circ\text{C}$ unless otherwise specified)

Parameter	Symbol	Test conditions	Min	Typ	Max	Unit
Collector-base breakdown voltage	$V_{(BR)CBO}$	$I_C=10\mu\text{A}, I_E=0$	60			V
Collector-emitter breakdown voltage	$V_{(BR)CEO}$	$I_C=1\text{mA}, I_B=0$	40			V
Emitter-base breakdown voltage	$V_{(BR)EBO}$	$I_E=10\mu\text{A}, I_C=0$	6			V
Collector cut-off current	I_{CEX}	$V_{CE}=30\text{V}, V_{EB(off)}=3\text{V}$			50	nA
Emitter cut-off current	I_{EBO}	$V_{EB}=5\text{V}, I_C=0$			100	nA
DC current gain	$h_{FE(1)}$	$V_{CE}=1\text{V}, I_C=0.1\text{mA}$	40			
	$h_{FE(2)}$	$V_{CE}=1\text{V}, I_C=1\text{mA}$	70			
	$h_{FE(3)}$	$V_{CE}=1\text{V}, I_C=10\text{mA}$	100		300	
	$h_{FE(4)}$	$V_{CE}=1\text{V}, I_C=50\text{mA}$	60			
Collector-emitter saturation voltage	$V_{CE(sat)}$	$I_C=10\text{mA}, I_B=1\text{mA}$			0.2	V
		$I_C=50\text{mA}, I_B=5\text{mA}$			0.3	V
Base-emitter saturation voltage	$V_{BE(sat)}$	$I_C=10\text{mA}, I_B=1\text{mA}$	0.65		0.85	V
		$I_C=50\text{mA}, I_B=5\text{mA}$			0.95	V
Transition frequency	f_T	$V_{CE}=20\text{V}, I_C=10\text{mA}, f=100\text{MHz}$	300			MHz
Collector output capacitance	C_{ob}	$V_{CB}=5\text{V}, I_E=0, f=1\text{MHz}$			4	pF
Base input capacitance	C_{ib}	$V_{EB}=0.5\text{V}, I_C=0, f=1\text{MHz}$			8	pF
Delay time	t_d	$V_{CC}=3\text{V}, V_{BE(off)}=-0.5\text{V}, I_C=10\text{mA}, I_{B1}=1\text{mA}$			35	ns
Rise time	t_r	$V_{CC}=3\text{V}, V_{BE(off)}=-0.5\text{V}, I_C=10\text{mA}, I_{B1}=1\text{mA}$			35	ns
Storage time	t_s	$V_{CC}=3\text{V}, I_C=10\text{mA}, I_{B1}=I_{B2}=1\text{mA}$			200	ns
Fall time	t_f	$V_{CC}=3\text{V}, I_C=10\text{mA}, I_{B1}=I_{B2}=1\text{mA}$			50	ns

Typical Characteristics

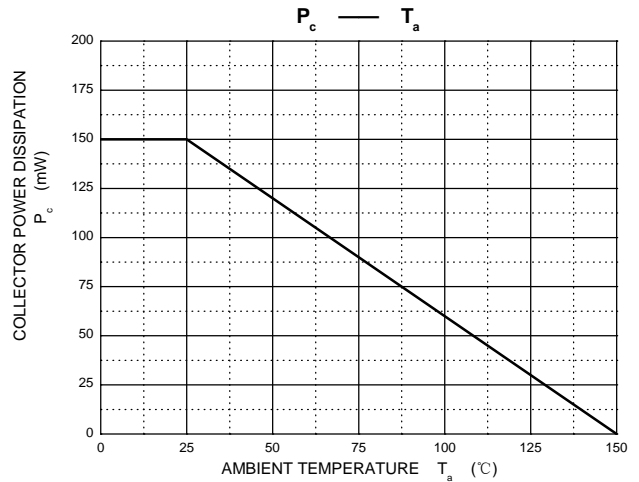
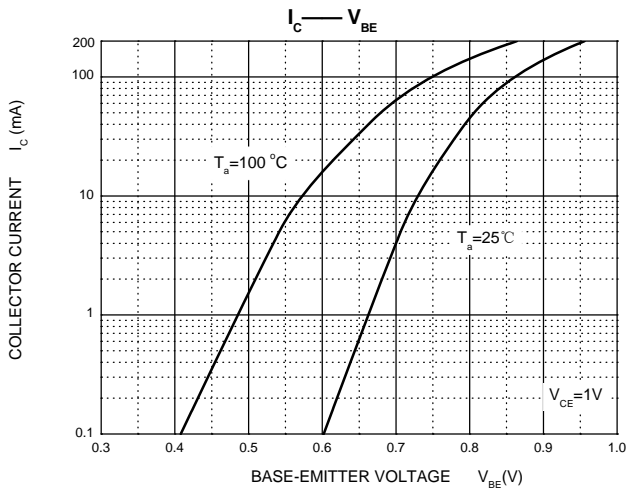
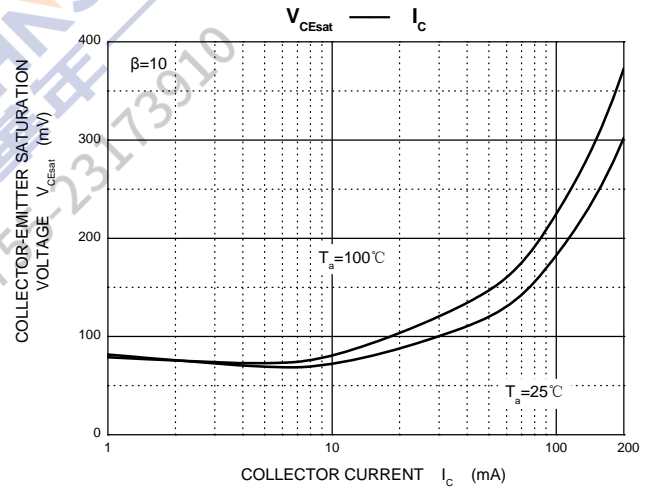
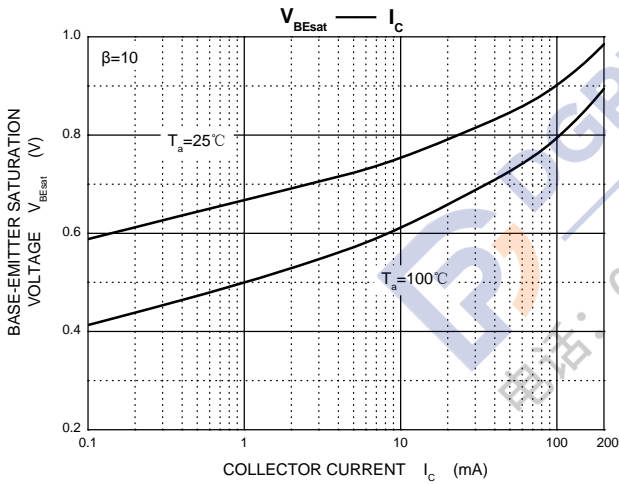
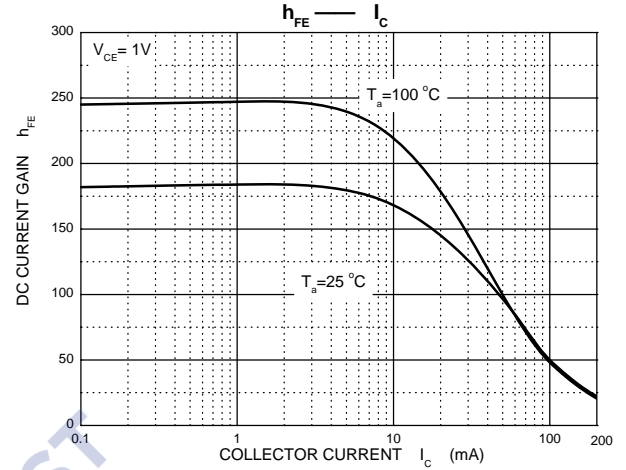
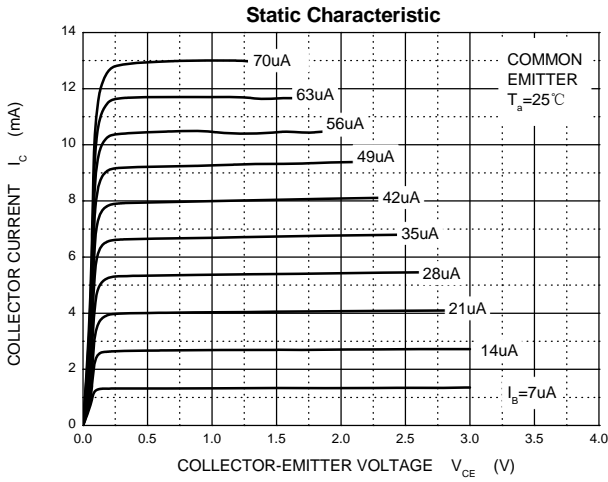

SOT-523 Package Outline Dimensions

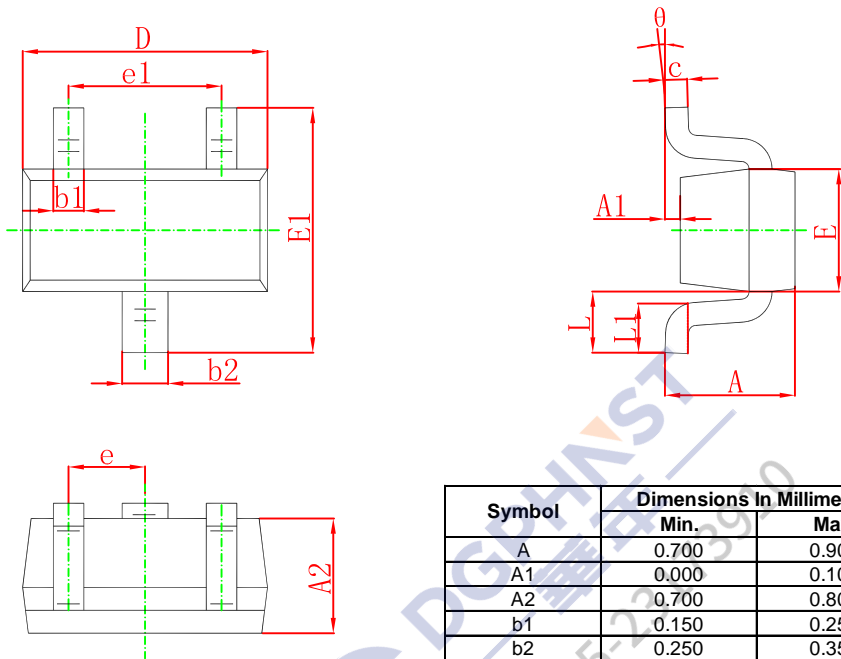

Symbol	Dimensions In Millimeters		Dimensions In Inches	
	Min.	Max.	Min.	Max.
A	0.700	0.900	0.028	0.035
A1	0.000	0.100	0.000	0.004
A2	0.700	0.800	0.028	0.031
b1	0.150	0.250	0.006	0.010
b2	0.250	0.350	0.010	0.014
c	0.100	0.200	0.004	0.008
D	1.500	1.700	0.059	0.067
E	0.700	0.900	0.028	0.035
E1	1.450	1.750	0.057	0.069
e	0.500 TYP.		0.020 TYP.	
e1	0.900	1.100	0.035	0.043
L	0.400 REF.		0.016 REF.	
L1	0.260	0.460	0.010	0.018
θ	0°	8°	0°	8°

SOT-523 Suggested Pad Layout

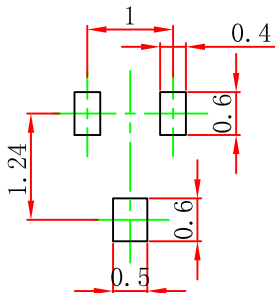

- Note:
1. Controlling dimension: in millimeters.
 2. General tolerance: $\pm 0.05\text{mm}$.
 3. The pad layout is for reference purposes only.

NOTICE

JSCJ reserves the right to make modifications, enhancements, improvements, corrections or other changes without further notice to any product herein. JSCJ does not assume any liability arising out of the application or use of any product described herein.

SOT-523 Tape and Reel

SOT-523 Embossed Carrier Tape

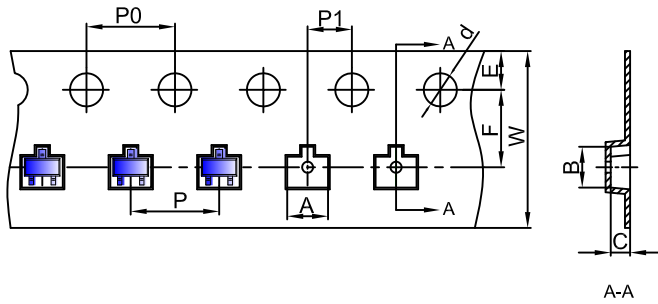

Packaging Description:

SOT-523 parts are shipped in tape. The carrier tape is made from a dissipative (carbon filled) polycarbonate resin. The cover tape is a multilayer film (Heat Activated Adhesive in nature) primarily composed of polyester film, adhesive layer, sealant, and anti-static sprayed agent. These reeled parts in standard option are shipped with 3,000 units per 7" or 17.8cm diameter reel. The reels are clear in color and is made of polystyrene plastic (anti-static coated).

Dimensions are in millimeter

Pkg type	A	B	C	d	E	F	P0	P	P1	W
SOT-523	1.85	1.85	0.875	Ø1.50	1.75	3.50	4.00	4.00	2.00	8.00

SOT-523 Tape Leader and Trailer

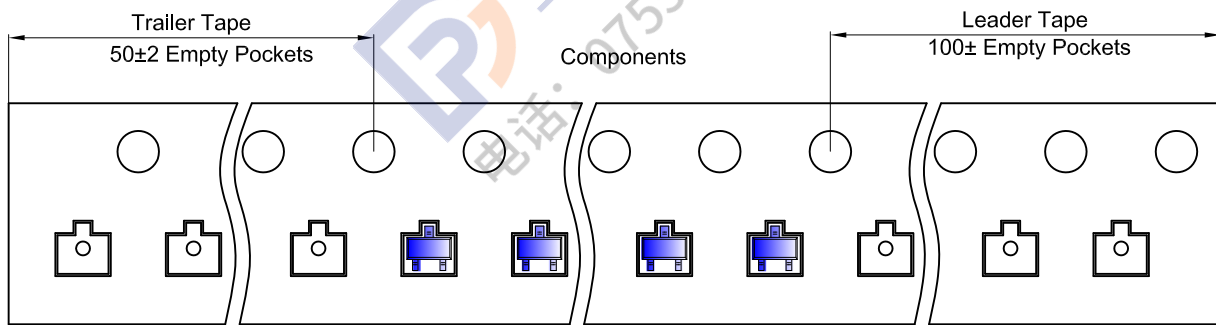

SOT-523 Reel

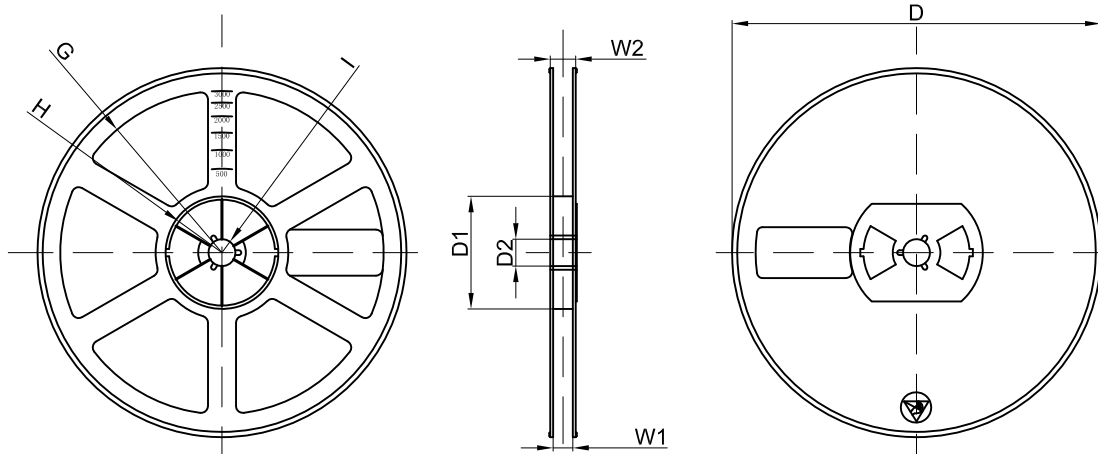

Dimensions are in millimeter

Reel Option	D	D1	D2	G	H	I	W1	W2
7" Dia	Ø178.00	54.40	13.00	R78.00	R25.60	R6.50	9.50	12.30

REEL	Reel Size	Box	Box Size(mm)	Carton	Carton Size(mm)	G.W.(kg)
3000 pcs	7 inch	45,000 pcs	203×203×195	180,000 pcs	438×438×220	