

## SOT-23 Plastic-Encapsulate Diodes

### BAR43/A/C/S SCHOTTKY BARRIER DIODE

SOT-23

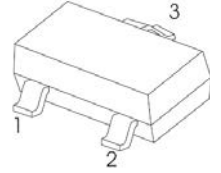

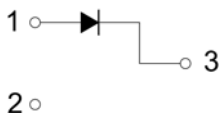
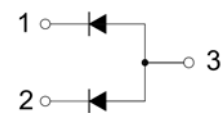
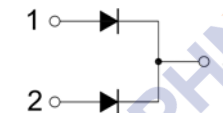
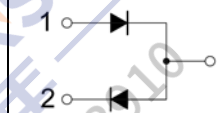

#### FEATURES

- Low Current Leakage
- For General Purpose Switching Applications

BAR43	BAR43A	BAR43C	BAR43S
			
MARKING:D95	MARKING: DB1	MARKING:DB2	MARKING:DA5

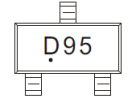
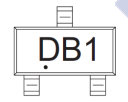
#### MARKING:

BAR43	BAR43A	BAR43C	BAR43S
			

Solid dot = Green molding compound device

#### MAXIMUM RATINGS ( $T_a=25^\circ\text{C}$ unless otherwise noted )

Symbol	Parameter	Value	Unit
$V_{RRM}$	Peak Repetitive Reverse Voltage	30	V
$V_{RWM}$	Working Peak Reverse Voltage		
$V_{R(RMS)}$	RMS Reverse Voltage	21	V
$I_{F(AV)}$	Average Rectified Forward Current	200	mA
$I_{FSM}$	Non-repetitive Peak Forward Surge Current @ $t=8.3\text{ms}$	0.75	A
$P_D$	Power Dissipation	200	mW
$R_{\theta JA}$	Thermal Resistance from Junction to Ambient	500	$^\circ\text{C}/\text{W}$
$T_j$	Operating Junction Temperature Range	-40 ~ +125	$^\circ\text{C}$
$T_{stg}$	Storage Temperature Range	-55 ~ +150	$^\circ\text{C}$

#### ELECTRICAL CHARACTERISTICS( $T_a=25^\circ\text{C}$ unless otherwise specified)

Parameter	Symbol	Test conditions	Min	Typ	Max	Unit
Reverse voltage	$V_{(BR)}$	$I_R=100\mu\text{A}$	30			V
Reverse current	$I_R$	$V_R=25\text{V}$			0.5	$\mu\text{A}$
Forward voltage	$V_F$	$I_F=2\text{mA}$	0.26		0.33	V
		$I_F=15\text{mA}$			0.45	
		$I_F=100\text{mA}$			0.8	
Reverse recovery time	$t_{rr}$	$I_F=I_R=10\text{mA}$ , $I_{rr}=0.1 \times I_R$ , $R_L=100\Omega$			5	ns

# Typical Characteristics

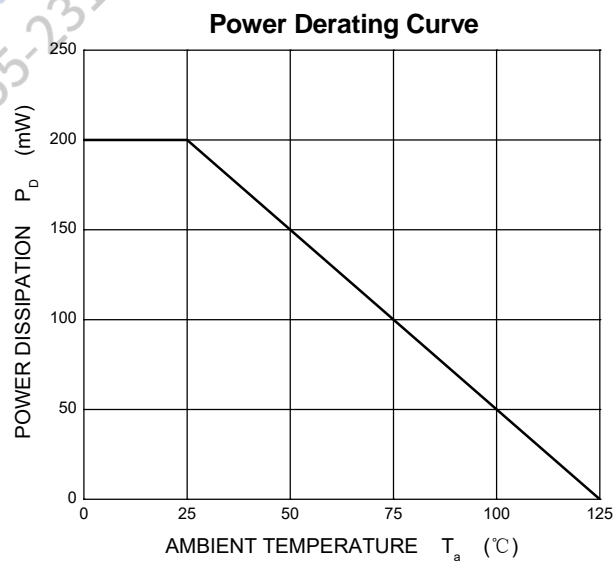
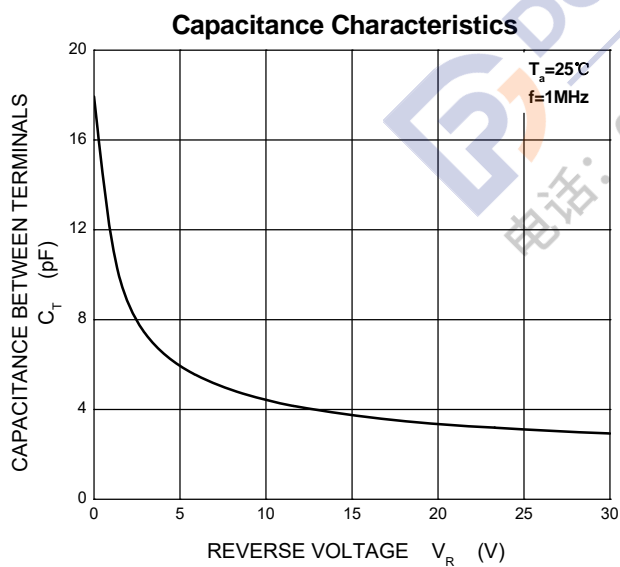
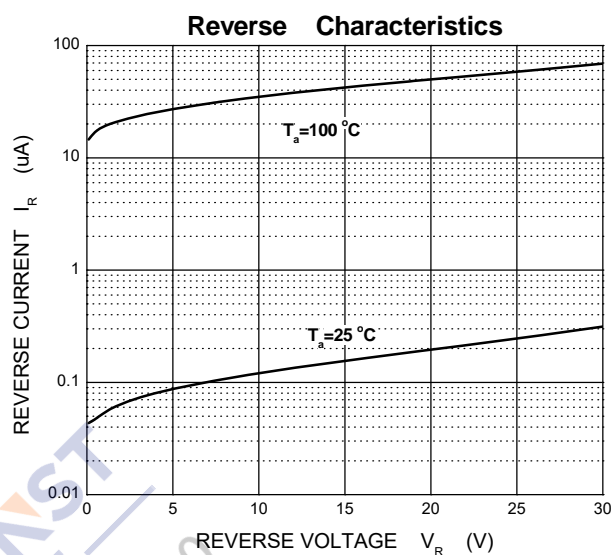
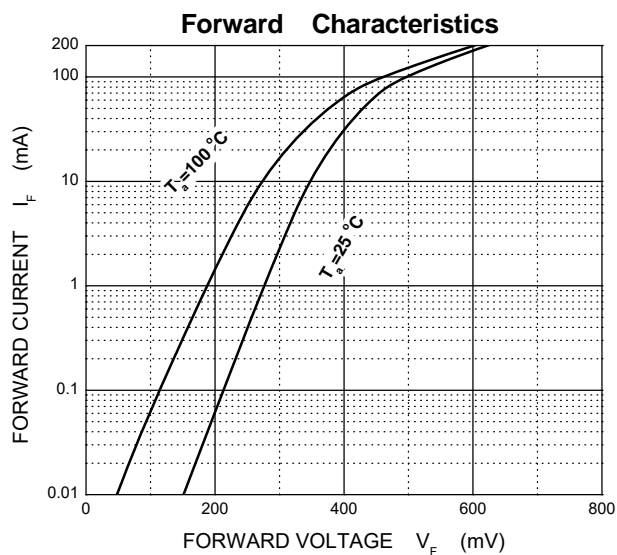

## SOT-23 Package Outline Dimensions



Symbol	Dimensions In Millimeters		Dimensions In Inches	
	Min	Max	Min	Max
A	0.900	1.150	0.035	0.045
A1	0.000	0.100	0.000	0.004
A2	0.900	1.050	0.035	0.041
b	0.300	0.500	0.012	0.020
c	0.080	0.150	0.003	0.006
D	2.800	3.000	0.110	0.118
E	1.200	1.400	0.047	0.055
E1	2.250	2.550	0.089	0.100
e	0.950 TYP		0.037 TYP	
e1	1.800	2.000	0.071	0.079
L	0.550 REF		0.022 REF	
L1	0.300	0.500	0.012	0.020
θ	0°	8°	0°	8°

## SOT-23 Suggested Pad Layout



**Note:**

1. Controlling dimension: in millimeters.
2. General tolerance:  $\pm 0.05\text{mm}$ .
3. The pad layout is for reference purposes only.

**NOTICE**

JSCJ reserves the right to make modifications, enhancements, improvements, corrections or other changes without further notice to any product herein. JSCJ does not assume any liability arising out of the application or use of any product described herein.

# SOT-23 Tape and Reel

## SOT-23 Embossed Carrier Tape

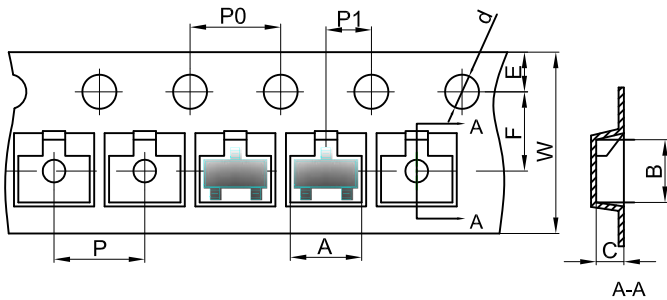

### Packaging Description:

SOT-23 parts are shipped in tape. The carrier tape is made from a dissipative (carbon filled) polycarbonate resin. The cover tape is a multilayer film (Heat Activated Adhesive in nature) primarily composed of polyester film, adhesive layer, sealant, and anti-static sprayed agent. These reeled parts in standard option are shipped with 3,000 units per 7" or 17.8cm diameter reel. The reels are clear in color and is made of polystyrene plastic (anti-static coated).

Dimensions are in millimeter

Pkg type	A	B	C	d	E	F	P0	P	P1	W
SOT-23	3.15	2.77	1.22	Ø1.50	1.75	3.50	4.00	4.00	2.00	8.00

## SOT-23 Tape Leader and Trailer

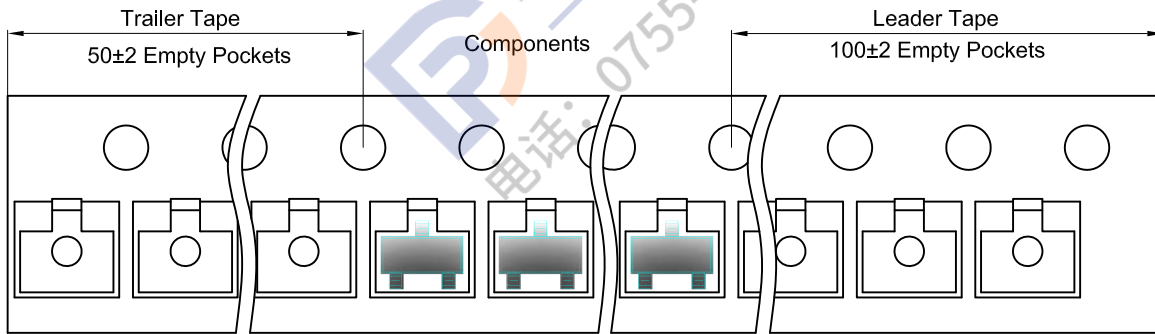

## SOT-23 Reel



Dimensions are in millimeter

Reel Option	D	D1	D2	G	H	I	W1	W2
7"Dia	Ø178.00	54.40	13.00	R78.00	R25.60	R6.50	9.50	12.30

REEL	Reel Size	Box	Box Size(mm)	Carton	Carton Size(mm)	G.W.(kg)
3000 pcs	7 inch	45,000 pcs	203×203×195	180,000 pcs	438×438×220	