

SOT-23-6L Plastic-Encapsulate Transistors

CJ818B TRANSISTOR (PNP)

DESCRIPTIONS

The device is manufactured in low voltage PNP Planar Technology with "Base Island" layout. The resulting Transistor shows exceptional high gain performance coupled with very low saturation voltage.

FEATURE

Very low collector to emitter saturation voltage

APPLICATIONS

- Power management in portable equipments
- Switching regulator in battery charge applications

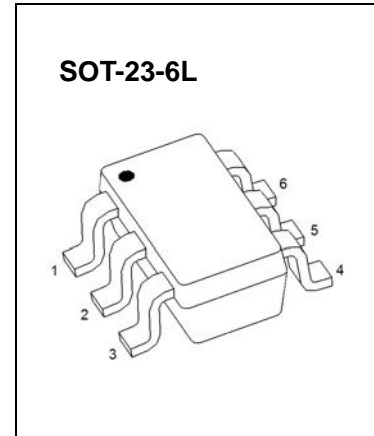

MARKING:

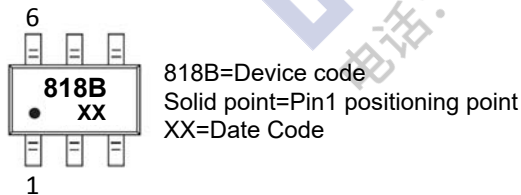

Equivalent Circuit

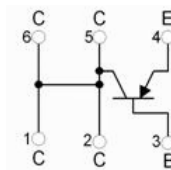

MAXIMUM RATINGS ($T_a=25^{\circ}\text{C}$ unless otherwise noted)

Symbol	Parameter	Value	Units
V_{CBO}	Collector-Base Voltage	-30	V
V_{CEO}	Collector-Emitter Voltage	-30	V
V_{EBO}	Emitter-Base Voltage	-5	V
I_C	Collector Current -Continuous	-3	A
P_C	Collector Dissipation	0.35	W
$R_{\theta JA}$	Thermal Resistance from Junction to Ambient	357	$^{\circ}\text{C}/\text{W}$
P_{tot}	Total Dissipation at $T_C = 25^{\circ}\text{C}$	1.2	W
$R_{\theta JC}$	Thermal Resistance from Junction to case (note 1)	104.2	$^{\circ}\text{C}/\text{W}$
T_J, T_{stg}	Operation Junction and Storage Temperature Range	-55~+150	$^{\circ}\text{C}$

Note 1: Package mounted on FR4 pcb 25mm x 25mm.

ELECTRICAL CHARACTERISTICS

$T_a=25\text{ }^\circ\text{C}$ unless otherwise specified

Parameter	Symbol	Test conditions	Min	Typ	Max	Unit
Collector-base breakdown voltage	$V_{(BR)CBO}$	$I_C=-100\mu\text{A}, I_E=0$	-30			V
Collector-emitter breakdown voltage	$V_{(BR)CEO}^*$	$I_C=-10\text{mA}, I_B=0$	-30			V
Emitter-base breakdown voltage	$V_{(BR)EBO}$	$I_E=-100\mu\text{A}, I_C=0$	-5			V
Collector cut-off current	I_{CBO}	$V_{CB}=-30\text{V}, I_E=0$			-0.1	μA
Emitter cut-off current	I_{EBO}	$V_{EB}=-5\text{V}, I_C=0$			-0.1	μA
DC current gain	h_{FE}^*	$V_{CE}=-1\text{V}, I_C=-0.5\text{A}$	100			
		$V_{CE}=-3\text{V}, I_C=-2.5\text{A}$	100			
Collector-emitter saturation voltage	$V_{CE(sat)}^*$	$I_C=-0.5\text{A}, I_B=-5\text{mA}$			-0.15	V
		$I_C=-1.2\text{A}, I_B=-12\text{mA}$			-0.45	V
		$I_C=-2\text{A}, I_B=-20\text{mA}$			-0.8	V
Base-emitter saturation voltage	$V_{BE(sat)}^*$	$I_C=-0.5\text{A}, I_B=-5\text{mA}$			-1.1	V
		$I_C=-1.2\text{A}, I_B=-12\text{mA}$			-1.1	V
		$I_C=-2\text{A}, I_B=-20\text{mA}$			-1.2	V
Base-emitter on voltage	$V_{BE(on)}^*$	$I_C=-0.5\text{A}, V_{CE}=-2\text{V}$			-1.1	V

*Pulse test: Pulse width $\leq 300\mu\text{s}$, duty cycle $\leq 2.0\%$.

Typical Characteristics

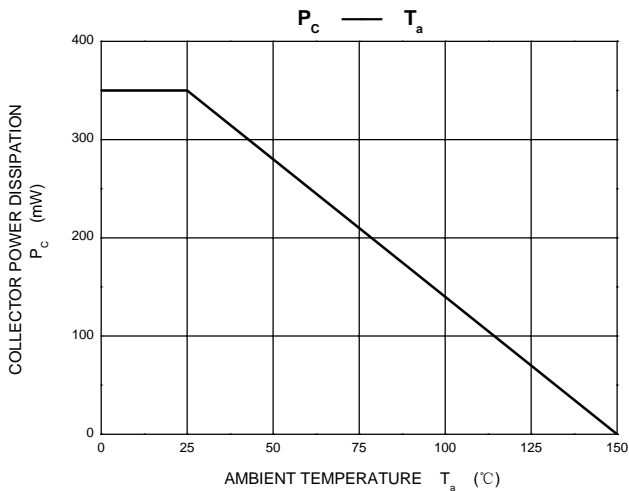
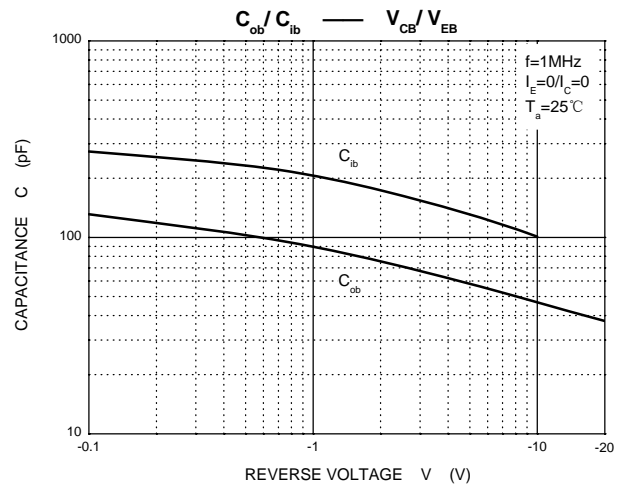
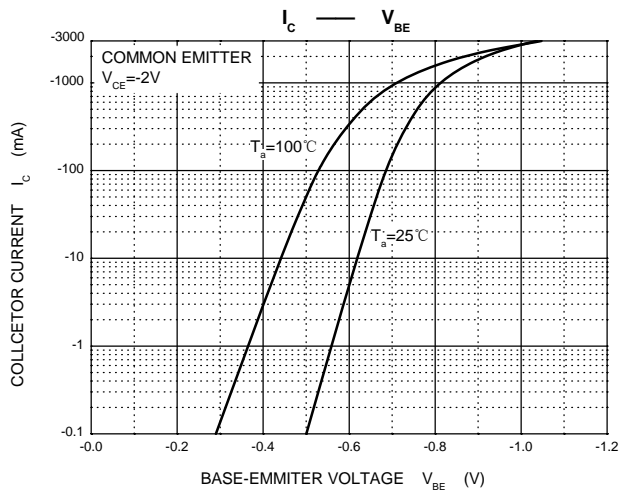
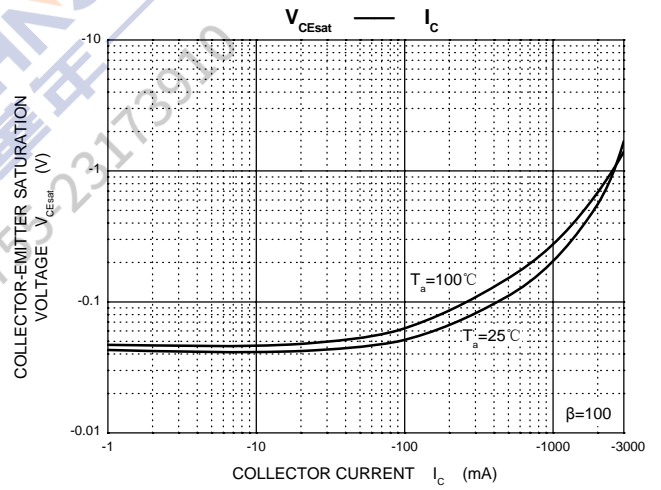
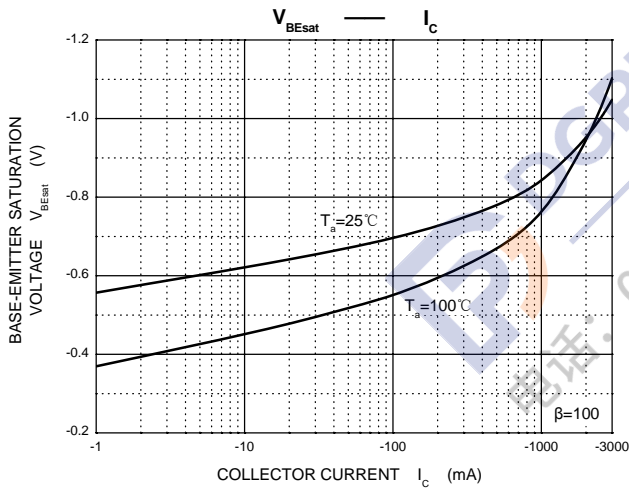
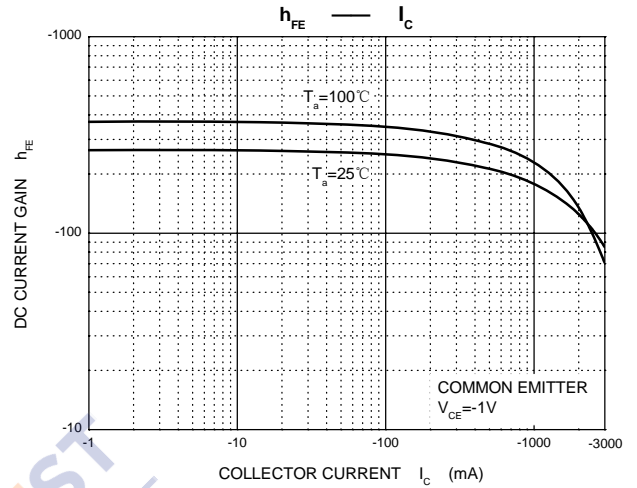
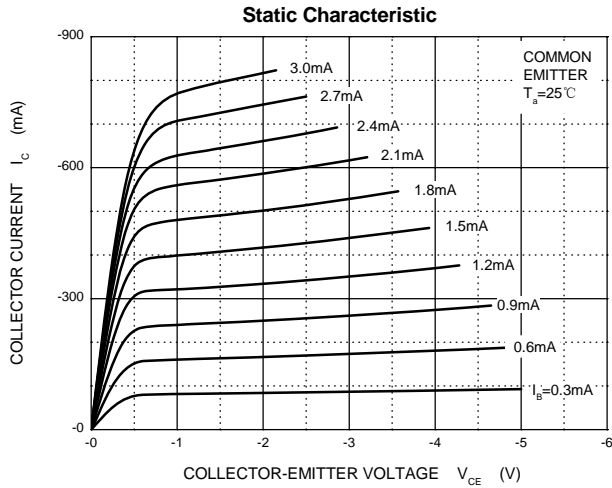

SOT-23-6L Package Outline Dimensions

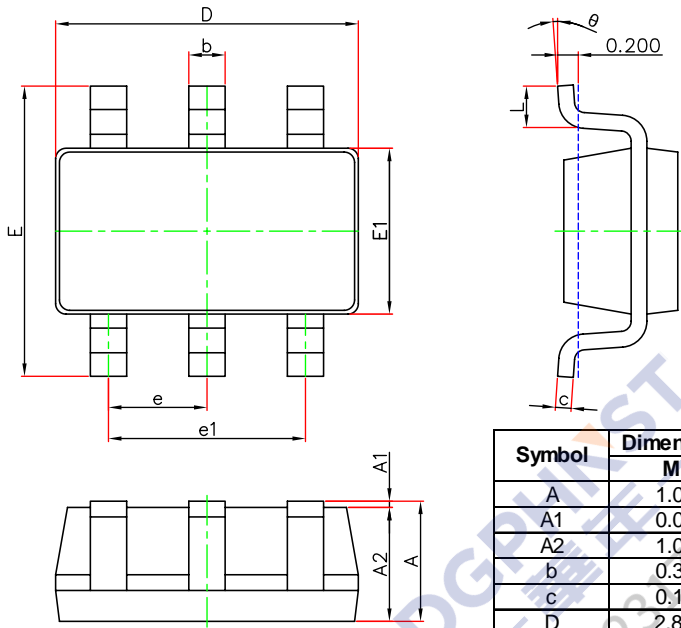

Symbol	Dimensions In Millimeters		Dimensions In Inches	
	Min.	Max.	Min.	Max.
A	1.050	1.250	0.041	0.049
A1	0.000	0.100	0.000	0.004
A2	1.050	1.150	0.041	0.045
b	0.300	0.500	0.012	0.020
c	0.100	0.200	0.004	0.008
D	2.820	3.020	0.111	0.119
E1	1.500	1.700	0.059	0.067
E	2.650	2.950	0.104	0.116
e	0.950(BSC)		0.037(BSC)	
e1	1.800	2.000	0.071	0.079
L	0.300	0.600	0.012	0.024
θ	0°	8°	0°	8°

SOT-23-6L Suggested Pad Layout

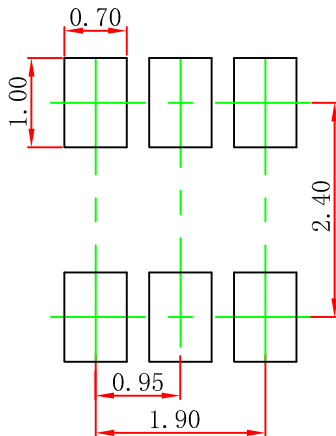

Note:

1. Controlling dimension: in millimeters.
2. General tolerance: ± 0.05 mm.
3. The pad layout is for reference purposes only.

NOTICE

JSCJ reserves the right to make modifications, enhancements, improvements, corrections or other changes without further notice to any product herein. JSCJ does not assume any liability arising out of the application or use of any product described herein.

SOT-23-6L Tape and Reel

SOT-23-6L Embossed Carrier Tape

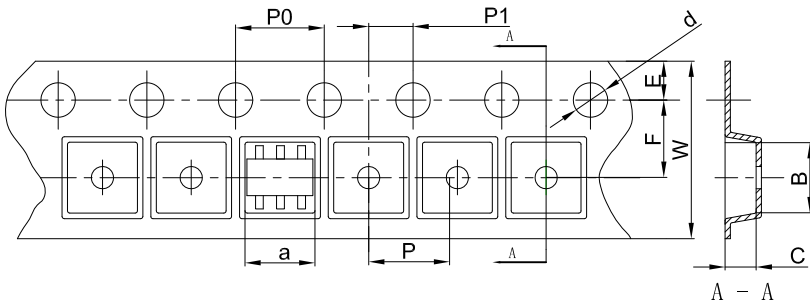

Packaging Description:

SOT-23-6L parts are shipped in tape. The carrier tape is made from a dissipative (carbon filled) polycarbonate resin. The cover tape is a multilayer film (Heat Activated Adhesive in nature) primarily composed of polyester film, adhesive layer, sealant, and anti-static sprayed agent. These reeled parts in standard option are shipped with 3,000 units per 7" or 18.0cm diameter reel. The reels are clear in color and is made of polystyrene plastic (anti-static coated).

Dimensions are in millimeter										
Pkg type	a	B	C	d	E	F	P0	P	P1	W
SOT-23-6L	3.23	3.17	1.37	Ø1.55	1.75	3.50	4.00	4.00	2.00	8.00

SOT-23-6L Tape Leader and Trailer

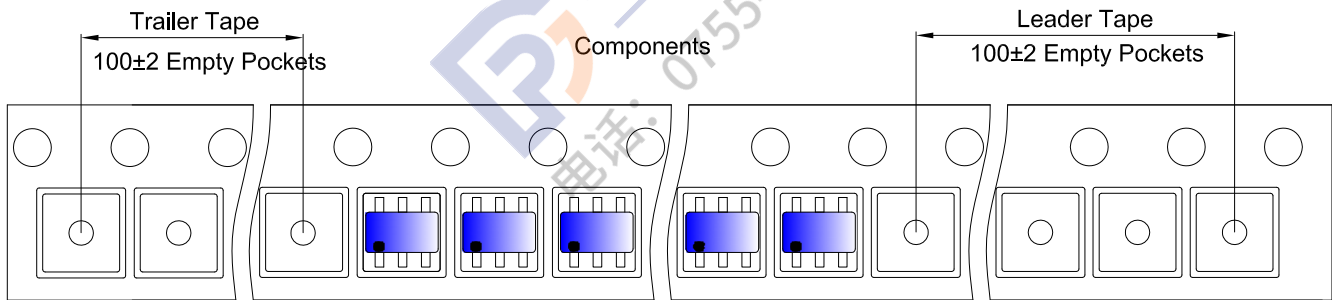

SOT-23-6L Reel

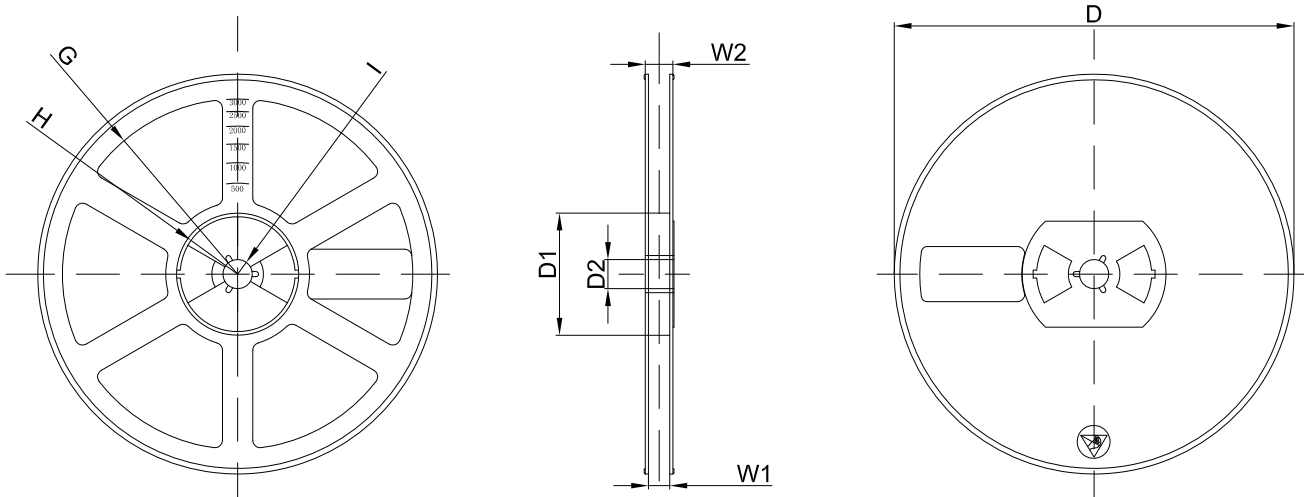

Dimensions are in millimeter								
Reel Option	D	D1	D2	G	H	I	W1	W2
7" Dia	Ø180.00	60.00	13.00	R78.00	R25.60	R6.50	9.50	13.10

REEL	Reel Size	Box	Box Size(mm)	Carton	Carton Size(mm)	G.W.(kg)
3000 pcs	7 inch	30,000 pcs	203×203×195	120,000 pcs	438×438×220	