

## SOT-323 Plastic-Encapsulate Transistors

**BC846W**

**BC847W**

**BC848W**

TRANSISTOR (NPN)

**SOT-323**

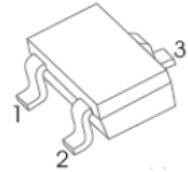

1. BASE  
2. EMITTER  
3. COLLECTOR

### FEATURES

- Ideally suited for automatic insertion
- For Switching and AF Amplifier Applications

### MAXIMUM RATINGS (T<sub>a</sub>=25°C unless otherwise noted)

| Symbol                            | Parameter  |        | Value   | Unit |
|-----------------------------------|--|--------|---------|------|
| V <sub>CBO</sub>                  | Collector-Base Voltage                           | BC846W | 80      | V    |
|                                   |  | BC847W | 50      |      |
|                                   |  | BC848W | 30      |      |
| V <sub>CEO</sub>                  | Collector-Emitter Voltage                        | BC846W | 65      | V    |
|                                   |  | BC847W | 45      |      |
|                                   |  | BC848W | 30      |      |
| V <sub>EBO</sub>                  | Emitter-Base Voltage                             | BC846W | 6       | V    |
|                                   |  | BC847W | 6       |      |
|                                   |  | BC848W | 5       |      |
| I <sub>C</sub>                    | Collector Current –Continuous                    |        | 0.1     | A    |
| P <sub>C</sub>                    | Collector Power Dissipation                      |        | 150     | mW   |
| R <sub>θJA</sub>                  | Thermal Resistance From Junction To Ambient      |        | 833     | °C/W |
| T <sub>J</sub> , T <sub>stg</sub> | Operation Junction and Storage Temperature Range |        | -55-150 | °C   |

### DEVICE MARKING

BC846AW=1A; BC846BW=1B;  
BC847AW=1E; BC847BW=1F; BC847CW=1G;  
BC848AW=1J; BC848BW=1K; BC848CW=1L

**ELECTRICAL CHARACTERISTICS (T<sub>a</sub>=25°C unless otherwise specified)**

| Parameter                            | Symbol              | Test conditions | Min   | Typ | Max | Unit       |     |
|--------------------------------------|---------------------|-----------------|---|-----|-----|------------|-----|
| Collector-base breakdown voltage     | BC846W              | $V_{CBO}$       | $I_C=10\mu A, I_E=0$  | 80  |     |            | V   |
|                                      | BC847W              |                 |   | 50  |     |            |     |
|                                      | BC848W              |                 |   | 30  |     |            |     |
| Collector-emitter breakdown voltage  | BC846W              | $V_{CEO}$       | $I_C=10mA, I_B=0$   | 65  |     |            | V   |
|                                      | BC847W              |                 |   | 45  |     |            |     |
|                                      | BC848W              |                 |   | 30  |     |            |     |
| Emitter-base breakdown voltage       | BC846W              | $V_{EBO}$       | $I_E=1\mu A, I_C=0$   | 6   |     |            | V   |
|                                      | BC847W              |                 |   | 6   |     |            |     |
|                                      | BC848W              |                 |   | 5   |     |            |     |
| Collector Cutoff Current             |                     | $I_{CBO}$       | $V_{CB}=30V$  |     |     | 15         | nA  |
| DC current gain                      | BC846AW,847AW,848AW | $h_{FE}$        | $V_{CE}=5V, I_C=10\mu A$  |     | 90  |            |     |
|                                      | BC846BW,847BW,848BW |                 |   |     | 150 |            |     |
|                                      | BC847CW,BC848CW     |                 |   |     | 270 |            |     |
|                                      | BC846AW,847AW,848AW |                 |   | 110 | 220 |            |     |
|                                      | BC846BW,847BW,848BW |                 |   | 200 | 450 |            |     |
| BC847CW,BC848CW                      | 420                 | 800             |   |     |     |            |     |
| Collector-emitter saturation voltage |                     | $V_{CE(sat)}$   | $I_C=10mA, I_B=0.5mA$   |     |     | 0.25       | V   |
|                                      |                     |                 | $I_C=100mA, I_B=5mA$  |     |     | 0.6        |     |
| Base-emitter saturation voltage      |                     | $V_{BE(sat)}$   | $I_C=10mA, I_B=0.5mA$   |     | 0.7 |            | V   |
|                                      |                     |                 | $I_C=100mA, I_B=5mA$  |     | 0.9 |            |     |
| Base-emitter voltage                 |                     | $V_{BE(on)}$    | $V_{CE}=5V, I_C=2mA$<br>$V_{CE}=5V, I_C=10mA$                   | 580 | 660 | 700<br>770 | mV  |
| Transition frequency                 |                     | $f_T$           | $V_{CE}=5V, I_C=10mA$<br>$f=100MHz$                             | 100 |     |            | MHz |
| Collector output capacitance         |                     | $C_{ob}$        | $V_{CB}=10V, f=1MHz$  |     |     | 4.5        | pF  |
| Noise figure                         | BC846AW,847AW,848AW | NF              | $V_{CE}=5V, I_C=0.2mA,$<br>$f=1KHz, R_S=2K\Omega$<br>$BW=200Hz$ |     |     | F€         | dB  |
|                                      | BC846BW,847BW,848BW |                 |   |     |     | 10         |     |
|                                      | BC847CW,BC848CW     |                 |   |     |     | 4          |     |

# Typical Characteristics

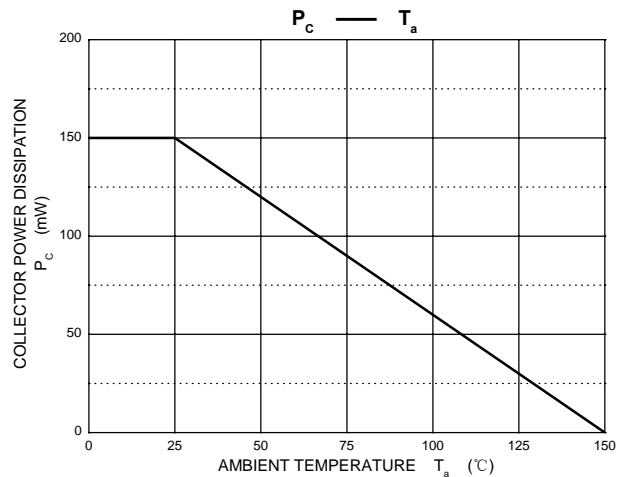
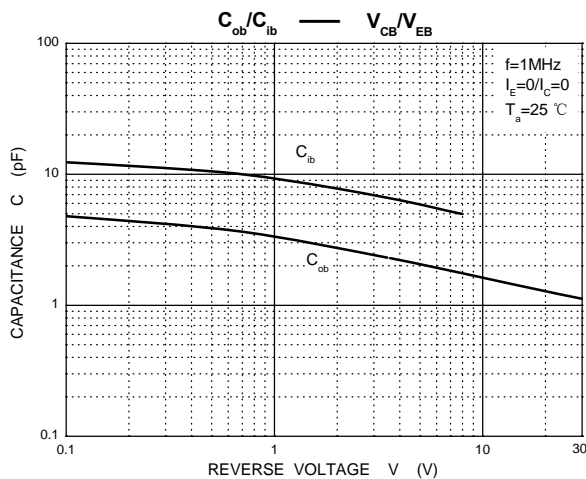
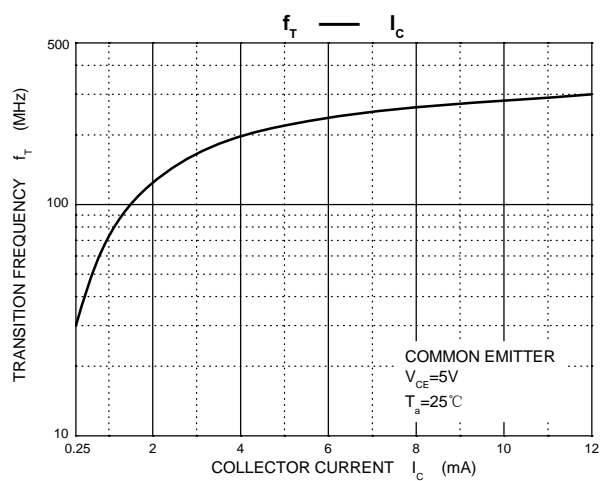
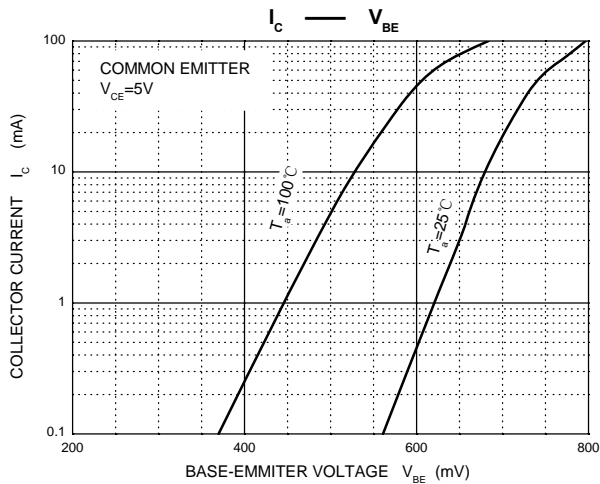
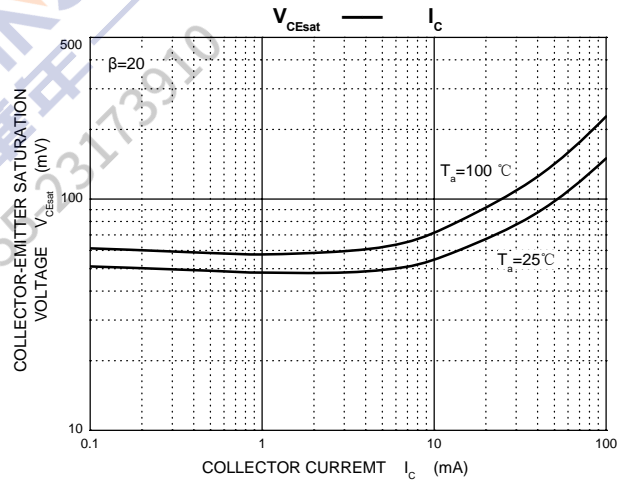
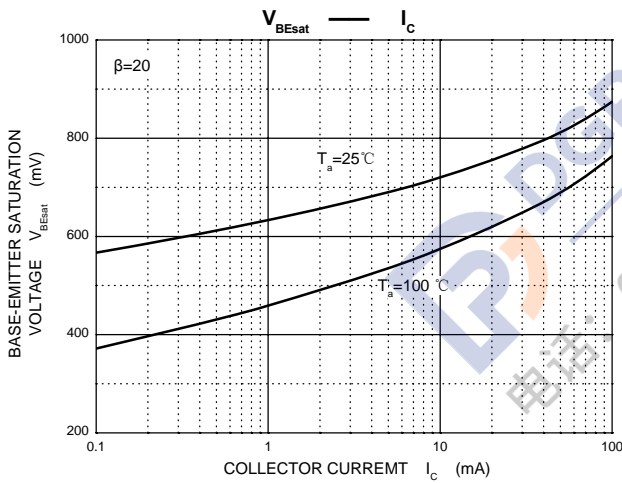
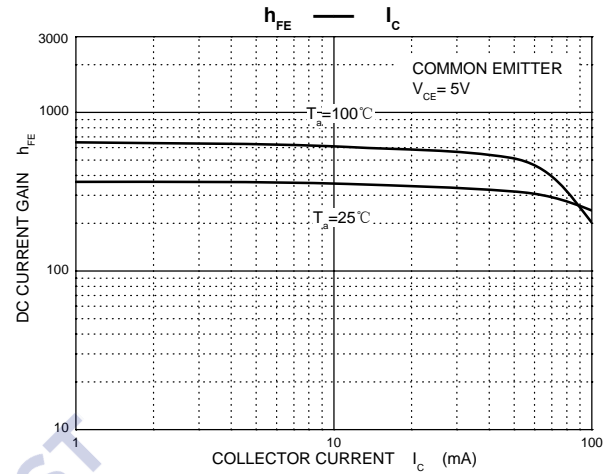
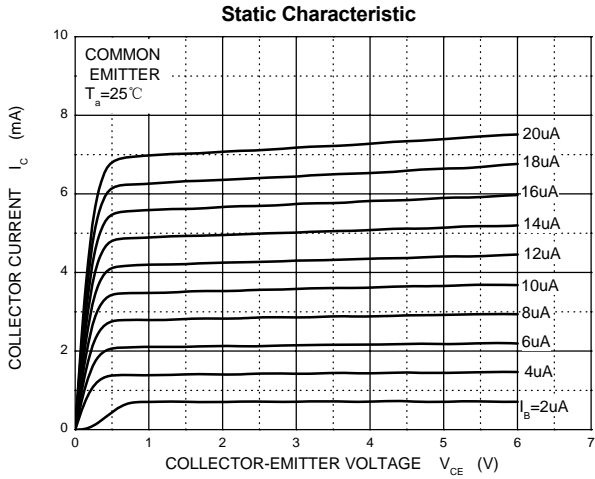

## SOT-323 Package Outline Dimensions

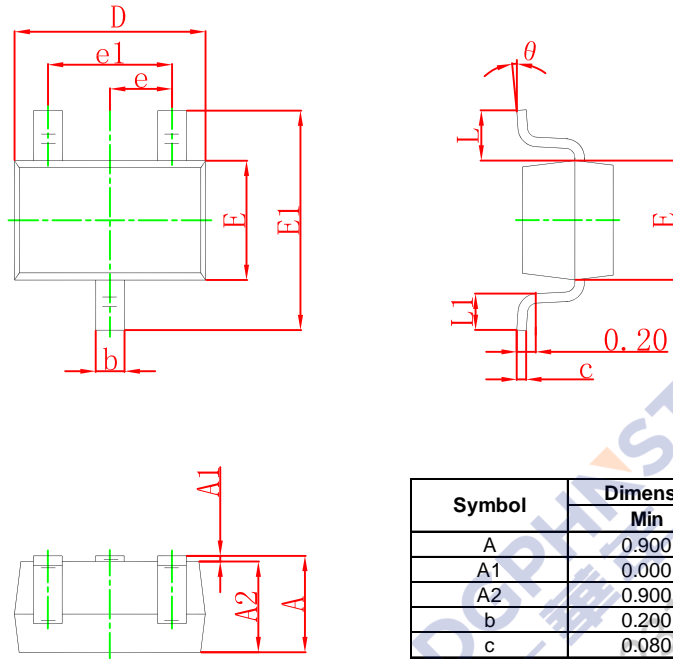

| Symbol | Dimensions In Millimeters |       | Dimensions In Inches |       |
|--------|---------------------------|-------|----------------------|-------|
|        | Min                       | Max   | Min                  | Max   |
| A      | 0.900                     | 1.100 | 0.035                | 0.043 |
| A1     | 0.000                     | 0.100 | 0.000                | 0.004 |
| A2     | 0.900                     | 1.000 | 0.035                | 0.039 |
| b      | 0.200                     | 0.400 | 0.008                | 0.016 |
| c      | 0.080                     | 0.150 | 0.003                | 0.006 |
| D      | 2.000                     | 2.200 | 0.079                | 0.087 |
| E      | 1.150                     | 1.350 | 0.045                | 0.053 |
| E1     | 2.150                     | 2.450 | 0.085                | 0.096 |
| e      | 0.650 TYP                 |       | 0.026 TYP            |       |
| e1     | 1.200                     | 1.400 | 0.047                | 0.055 |
| L      | 0.525 REF                 |       | 0.021 REF            |       |
| L1     | 0.260                     | 0.460 | 0.010                | 0.018 |
| θ      | 0°                        | 8°    | 0°                   | 8°    |

## SOT-323 Suggested Pad Layout

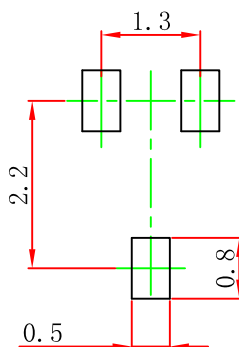

Note:

1. Controlling dimension: in millimeters.
2. General tolerance:  $\pm 0.05$  mm.
3. The pad layout is for reference purposes only.

### NOTICE

JSCJ reserves the right to make modifications, enhancements, improvements, corrections or other changes without further notice to any product herein. JSCJ does not assume any liability arising out of the application or use of any product described herein.

# SOT-323 Tape and Reel

## SOT-323 Embossed Carrier Tape

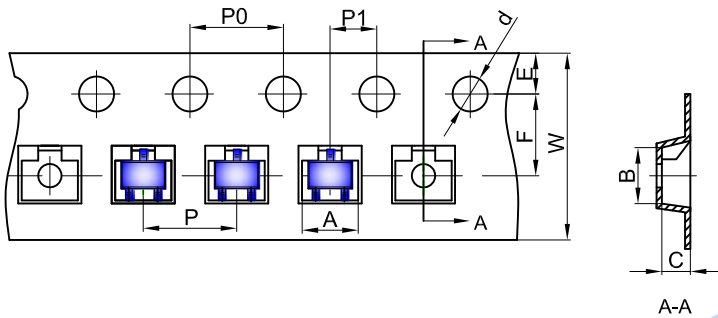

**Packaging Description:**  
 SOT-323 parts are shipped in tape. The carrier tape is made from a dissipative (carbon filled) polycarbonate resin. The cover tape is a multilayer film (Heat Activated Adhesive in nature) primarily composed of polyester film, adhesive layer, sealant, and anti-static sprayed agent. These reeled parts in standard option are shipped with 3,000 units per 7" or 17.8cm diameter reel. The reels are clear in color and is made of polystyrene plastic (anti-static coated).

| Dimensions are in millimeter |      |      |      |       |      |      |      |      |      |      |
|------------------------------|------|------|------|-------|------|------|------|------|------|------|
| Pkg type                     | A    | B    | C    | d     | E    | F    | P0   | P    | P1   | W    |
| SOT-323                      | 2.25 | 2.55 | 1.19 | Ø1.55 | 1.75 | 3.50 | 4.00 | 4.00 | 2.00 | 8.00 |

## SOT-323 Tape Leader and Trailer

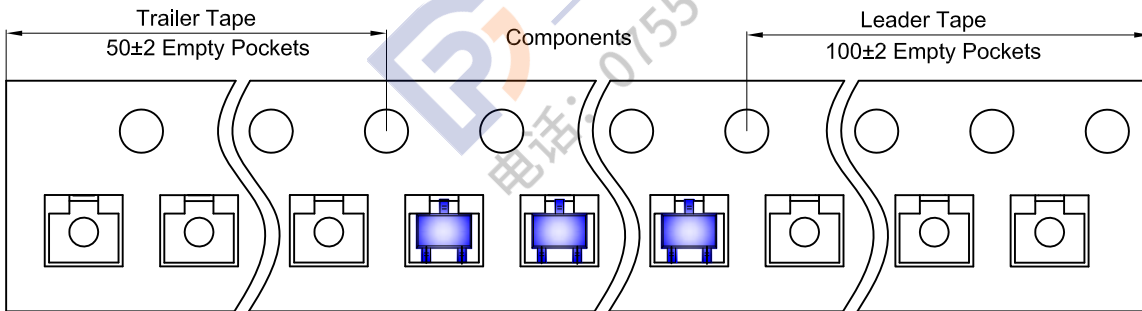

## SOT-323 Reel

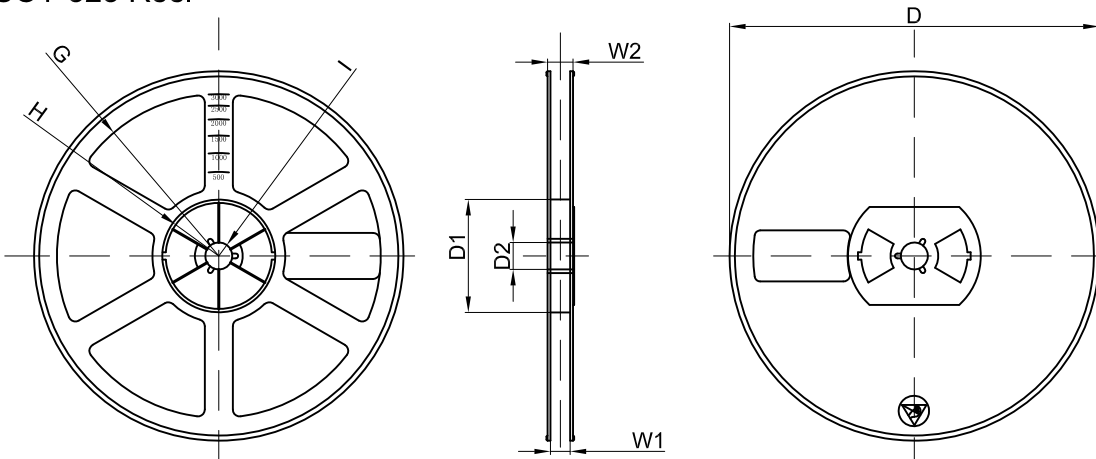

| Dimensions are in millimeter |         |       |       |        |        |       |      |       |
|------------------------------|---------|-------|-------|--------|--------|-------|------|-------|
| Reel Option                  | D       | D1    | D2    | G      | H      | I     | W1   | W2    |
| 7" Dia                       | Ø178.00 | 54.40 | 13.00 | R78.00 | R25.60 | R6.50 | 9.50 | 12.30 |

| REEL     | Reel Size | Box        | Box Size(mm) | Carton      | Carton Size(mm) | G.W.(kg) |
|----------|-----------|------------|--------------|-------------|-----------------|----------|
| 3000 pcs | 7 inch    | 45,000 pcs | 203×203×195  | 180,000 pcs | 438×438×220     |          |