

## SOT-523 Plastic-Encapsulate Transistors

### BC857T TRANSISTOR (PNP)

#### FEATURES

- Ideally suited for automatic insertion
- For Switching and AF Amplifier Applications

#### SOT-523

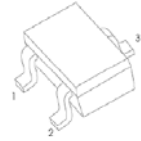

1. BASE
2. EMITTER
3. COLLECTOR

#### MAXIMUM RATINGS (T<sub>a</sub>=25°C unless otherwise noted)

Symbol	Parameter	Value	Unit
V <sub>CBO</sub>	Collector-Base Voltage	-50	V
V <sub>CEO</sub>	Collector-Emitter Voltage	-45	V
V <sub>EBO</sub>	Emitter-Base Voltage	-6	V
I <sub>C</sub>	Collector Current –Continuous	-0.1	A
P <sub>C</sub>	Collector Power Dissipation	150	mW
T <sub>J</sub> , T <sub>stg</sub>	Operation Junction and Storage Temperature Range	-55-150	°C

#### ELECTRICAL CHARACTERISTICS (T<sub>a</sub>=25°C unless otherwise specified)

Parameter	Symbol	Test conditions	Min	Typ	Max	Unit
Collector-base breakdown voltage	V <sub>(BR)CBO</sub>	I <sub>C</sub> = -10μA, I <sub>E</sub> =0	-50			V
Collector-emitter breakdown voltage	V <sub>(BR)CEO</sub>	I <sub>C</sub> = -10mA, I <sub>B</sub> =0	-45			V
Emitter-base breakdown voltage	V <sub>(BR)EBO</sub>	I <sub>E</sub> = -1μA, I <sub>C</sub> =0	-6			V
Collector Cutoff Current	I <sub>CB0</sub>	V <sub>CB</sub> =-30V			-15	nA
DC current gain	h <sub>FE</sub>	V <sub>CE</sub> =-5V, I <sub>C</sub> =-2mA	125		800	
Collector-emitter saturation voltage	V <sub>CE(sat)</sub>	I <sub>C</sub> =-10mA, I <sub>B</sub> =-0.5 mA I <sub>C</sub> =-100mA, I <sub>B</sub> =-5 mA			-0.3 -0.65	V
Base-emitter saturation voltage	V <sub>BE(sat)</sub>	I <sub>C</sub> =-10mA, I <sub>B</sub> =-0.5 mA I <sub>C</sub> =-100mA, I <sub>B</sub> = -5 mA		-0.7 -0.9		V
Base-emitter voltage	V <sub>BE(on)</sub>	V <sub>CE</sub> = -5V, I <sub>C</sub> = -2mA V <sub>CE</sub> = -5V, I <sub>C</sub> = -10mA	-600		-750 -820	mV
Transition frequency	f <sub>T</sub>	V <sub>CE</sub> = -5 V, I <sub>C</sub> = -10mA f=100MHz	100			MHz
Collector output capacitance	C <sub>ob</sub>	V <sub>CB</sub> =-10V, f=1MHz			4.5	pF
Noise figure	NF	V <sub>CE</sub> =-5V, I <sub>C</sub> =-0.2mA, f=1kHz, R <sub>S</sub> =2kΩ, BW=200Hz			10	dB

#### CLASSIFICATION OF h<sub>FE</sub>

Rank	5	B	C
Range	18) -250	88\$ -4+	( 8\$!, \$\$
Marking	E	F	G

# Typical Characteristics

Static Characteristic

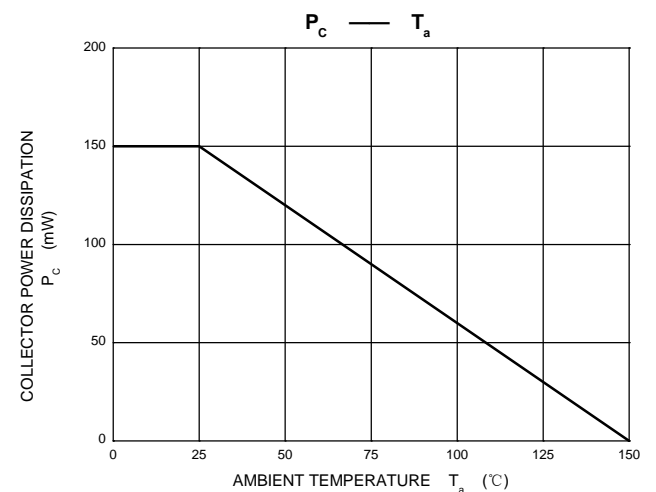
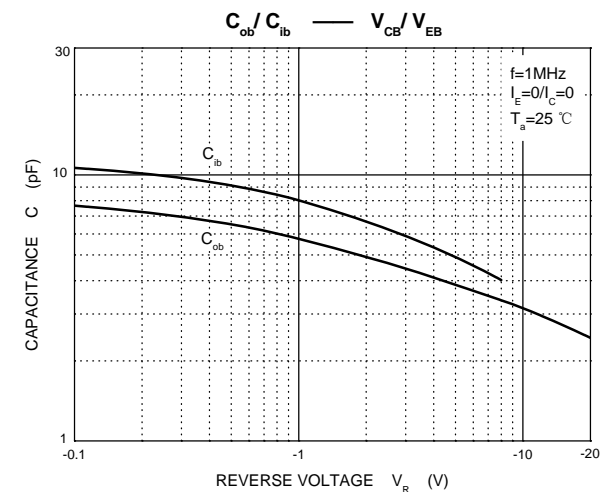
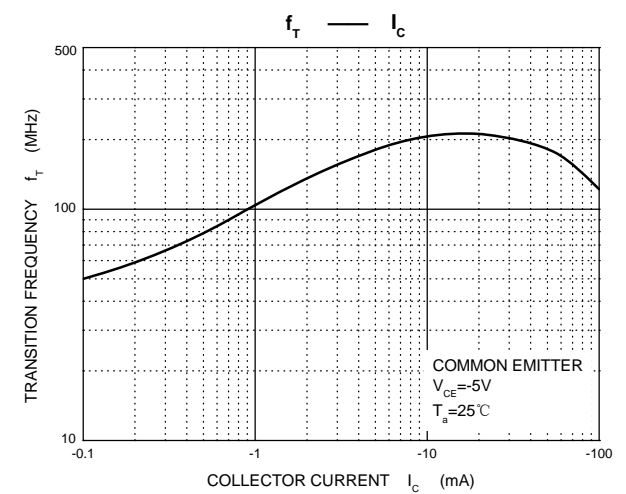
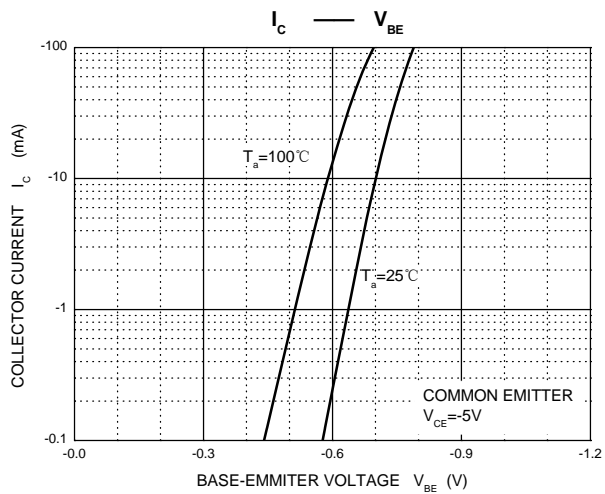
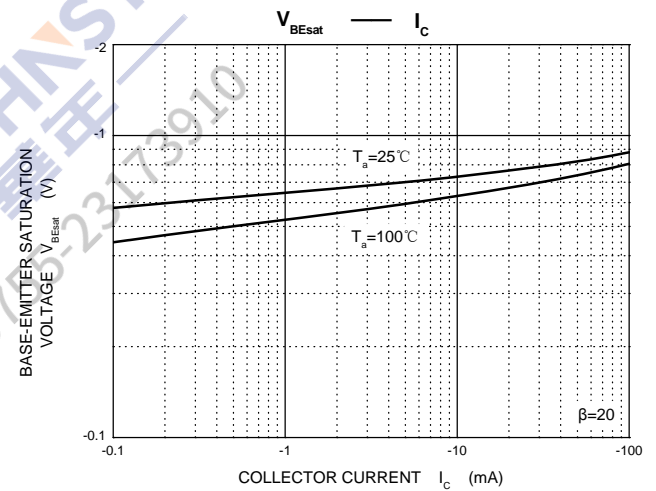
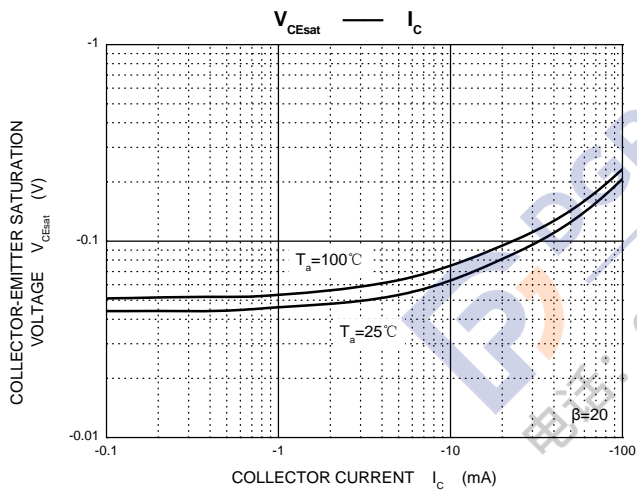
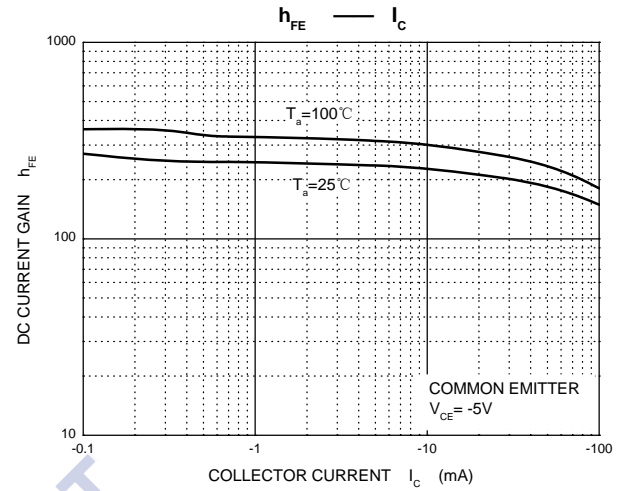
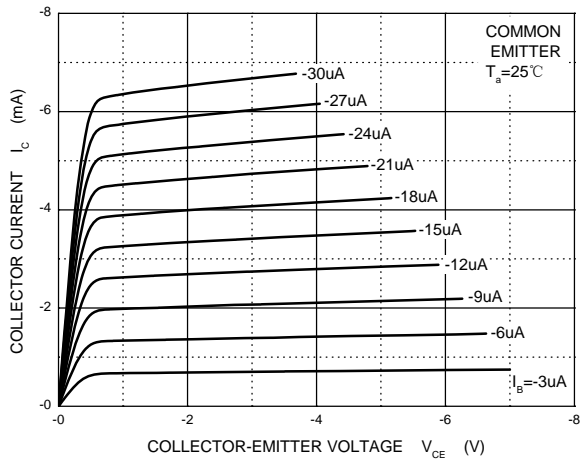

## SOT-523 Package Outline Dimensions

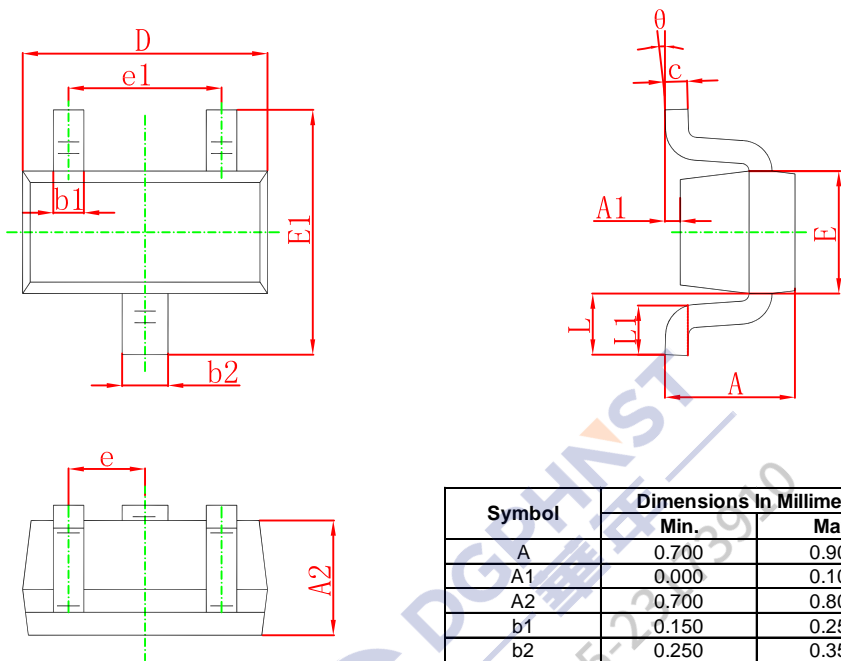

Symbol	Dimensions In Millimeters		Dimensions In Inches	
	Min.	Max.	Min.	Max.
A	0.700	0.900	0.028	0.035
A1	0.000	0.100	0.000	0.004
A2	0.700	0.800	0.028	0.031
b1	0.150	0.250	0.006	0.010
b2	0.250	0.350	0.010	0.014
c	0.100	0.200	0.004	0.008
D	1.500	1.700	0.059	0.067
E	0.700	0.900	0.028	0.035
E1	1.450	1.750	0.057	0.069
e	0.500 TYP.		0.020 TYP.	
e1	0.900	1.100	0.035	0.043
L	0.400 REF.		0.016 REF.	
L1	0.260	0.460	0.010	0.018
θ	0°	8°	0°	8°

## SOT-523 Suggested Pad Layout

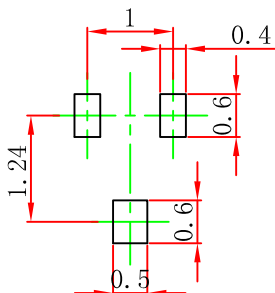

- Note:
1. Controlling dimension: in millimeters.
  2. General tolerance:  $\pm 0.05\text{mm}$ .
  3. The pad layout is for reference purposes only.

### NOTICE

JSCJ reserves the right to make modifications, enhancements, improvements, corrections or other changes without further notice to any product herein. JSCJ does not assume any liability arising out of the application or use of any product described herein.

# SOT-523 Tape and Reel

## SOT-523 Embossed Carrier Tape

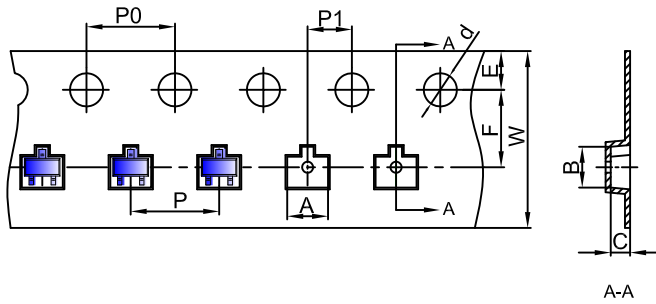

### Packaging Description:

SOT-523 parts are shipped in tape. The carrier tape is made from a dissipative (carbon filled) polycarbonate resin. The cover tape is a multilayer film (Heat Activated Adhesive in nature) primarily composed of polyester film, adhesive layer, sealant, and anti-static sprayed agent. These reeled parts in standard option are shipped with 3,000 units per 7" or 17.8cm diameter reel. The reels are clear in color and is made of polystyrene plastic (anti-static coated).

Dimensions are in millimeter

Pkg type	A	B	C	d	E	F	P0	P	P1	W
SOT-523	1.85	1.85	0.875	Ø1.50	1.75	3.50	4.00	4.00	2.00	8.00

## SOT-523 Tape Leader and Trailer

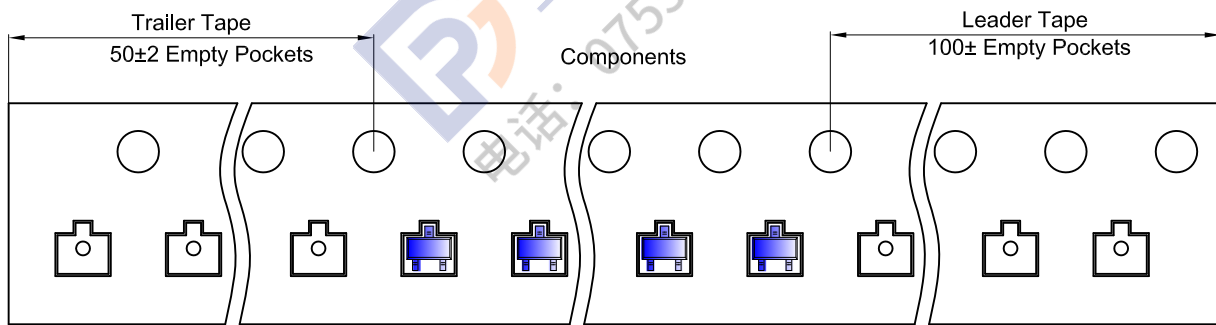

## SOT-523 Reel

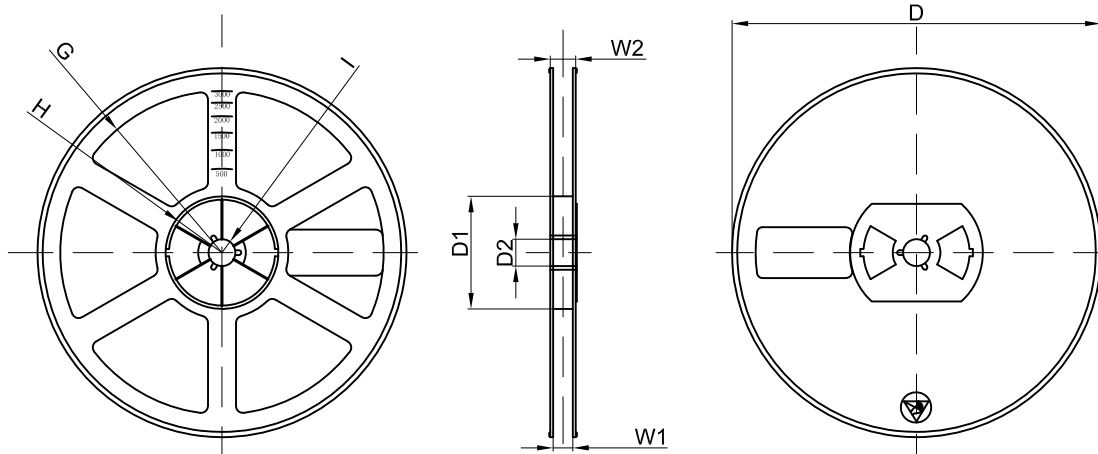

Dimensions are in millimeter

Reel Option	D	D1	D2	G	H	I	W1	W2
7" Dia	Ø178.00	54.40	13.00	R78.00	R25.60	R6.50	9.50	12.30

REEL	Reel Size	Box	Box Size(mm)	Carton	Carton Size(mm)	G.W.(kg)
3000 pcs	7 inch	45,000 pcs	203×203×195	180,000 pcs	438×438×220	