

**SOT-323 Plastic-Encapsulate Transistors**

**BC846W**

**BC847W**

**BC848W**

TRANSISTOR (NPN)

**SOT-323**

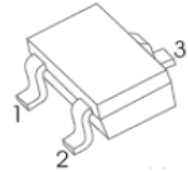

- 1. BASE
- 2. EMITTER
- 3. COLLECTOR

**FEATURES**

- Ideally suited for automatic insertion
- For Switching and AF Amplifier Applications

**MAXIMUM RATINGS (Ta=25°C unless otherwise noted)**

Symbol	Parameter		Value	Unit
<b>V<sub>CBO</sub></b>	Collector-Base Voltage	BC846W	80	V
		BC847W	50	
		BC848W	30	
<b>V<sub>CEO</sub></b>	Collector-Emitter Voltage	BC846W	65	V
		BC847W	45	
		BC848W	30	
<b>V<sub>EBO</sub></b>	Emitter-Base Voltage	BC846W	6	V
		BC847W	6	
		BC848W	5	
<b>I<sub>C</sub></b>	Collector Current –Continuous		0.1	A
<b>P<sub>C</sub></b>	Collector Power Dissipation		150	mW
<b>R<sub>θJA</sub></b>	Thermal Resistance From Junction To Ambient		833	°C/W
<b>T<sub>J</sub>, T<sub>stg</sub></b>	Operation Junction and Storage Temperature Range		-55-150	°C

**DEVICE MARKING**

BC846AW=1A; BC846BW=1B;  
 BC847AW=1E; BC847BW=1F; BC847CW=1G;  
 BC848AW=1J; BC848BW=1K; BC848CW=1L

**ELECTRICAL CHARACTERISTICS (T<sub>a</sub>=25°C unless otherwise specified)**

Parameter	Symbol	Test conditions	Min	Typ	Max	Unit	
Collector-base breakdown voltage	BC846W	$V_{CBO}$	$I_C=10\mu A, I_E=0$	80			V
	BC847W			50			
	BC848W			30			
Collector-emitter breakdown voltage	BC846W	$V_{CEO}$	$I_C=10mA, I_B=0$	65			V
	BC847W			45			
	BC848W			30			
Emitter-base breakdown voltage	BC846W	$V_{EBO}$	$I_E=1\mu A, I_C=0$	6			V
	BC847W			6			
	BC848W			5			
Collector Cutoff Current		$I_{CBO}$	$V_{CB}=30V$			15	nA
DC current gain	BC846AW,847AW,848AW	$h_{FE}$	$V_{CE}=5V, I_C=10\mu A$		90		
	BC846BW,847BW,848BW				150		
	BC847CW,BC848CW				270		
	BC846AW,847AW,848AW			110	220		
	BC846BW,847BW,848BW			200	450		
BC847CW,BC848CW	420	800					
Collector-emitter saturation voltage		$V_{CE(sat)}$	$I_C=10mA, I_B=0.5mA$			0.25	V
			$I_C=100mA, I_B=5mA$			0.6	
Base-emitter saturation voltage		$V_{BE(sat)}$	$I_C=10mA, I_B=0.5mA$		0.7		V
			$I_C=100mA, I_B=5mA$		0.9		
Base-emitter voltage		$V_{BE(on)}$	$V_{CE}=5V, I_C=2mA$	580	660	700	mV
			$V_{CE}=5V, I_C=10mA$			770	
Transition frequency		$f_T$	$V_{CE}=5V, I_C=10mA$ $f=100MHz$	100			MHz
Collector output capacitance		$C_{ob}$	$V_{CB}=10V, f=1MHz$			4.5	pF
Noise figure	BC846AW,847AW,848AW	NF	$V_{CE}=5V, I_C=0.2mA,$ $f=1KHz, R_S=2K\Omega$ $BW=200Hz$			F€	dB
	BC846BW,847BW,848BW					10	
	BC847CW,BC848CW					4	

# Typical Characteristics

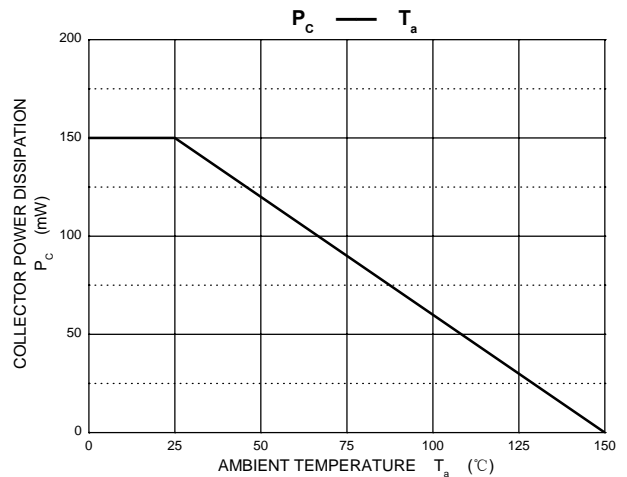
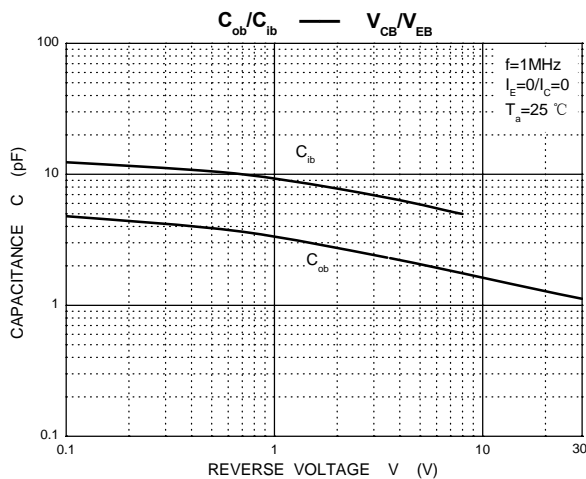
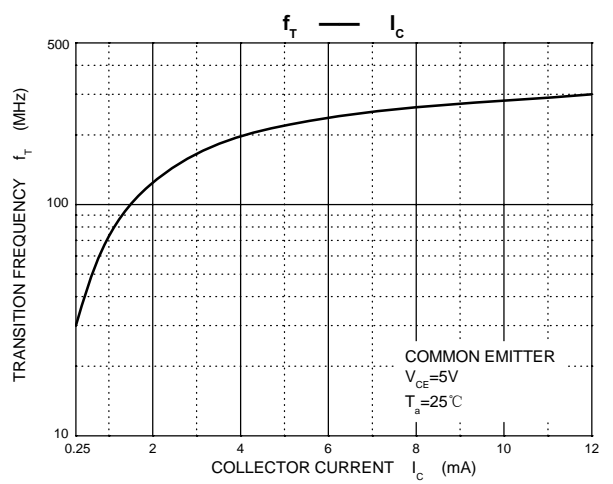
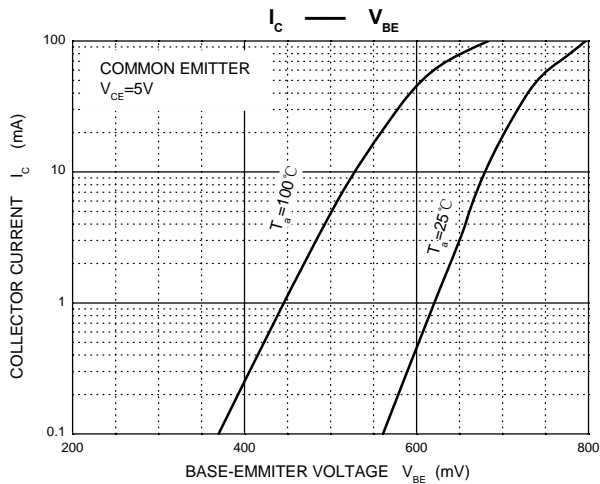
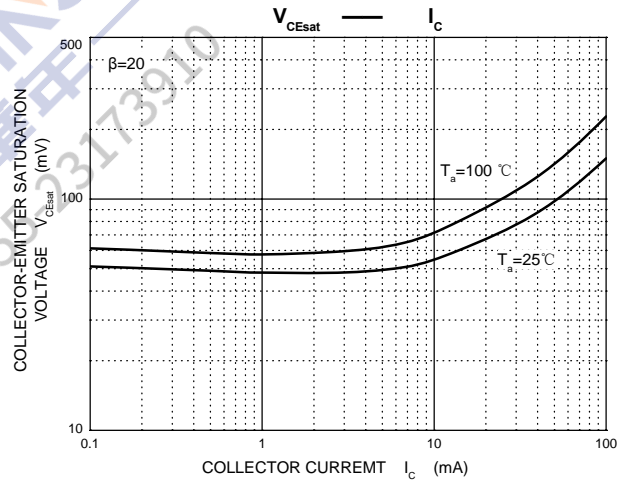
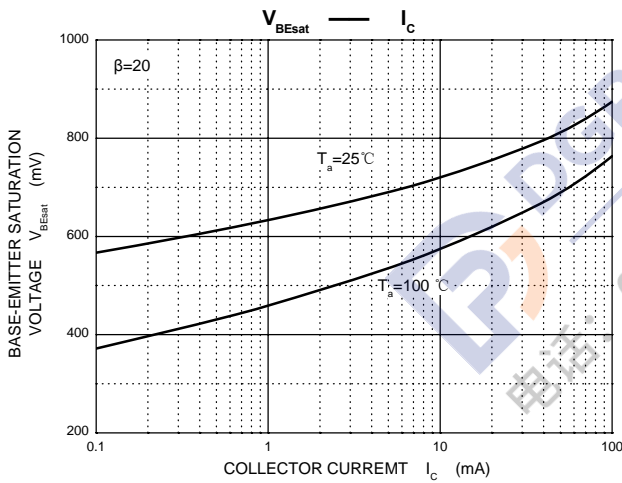
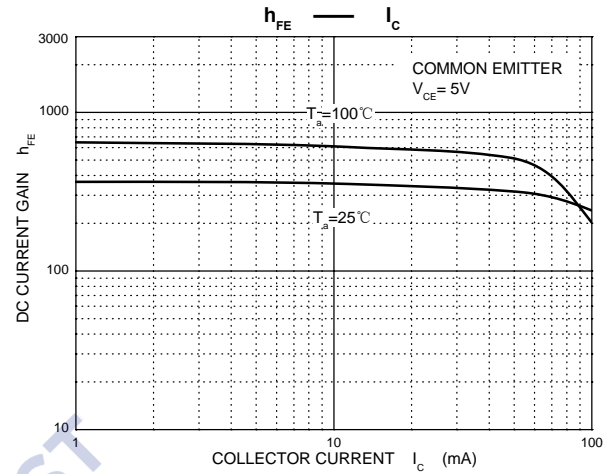
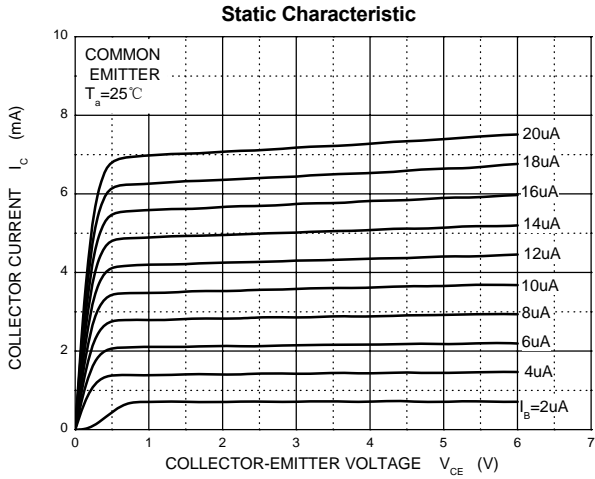

## SOT-323 Package Outline Dimensions

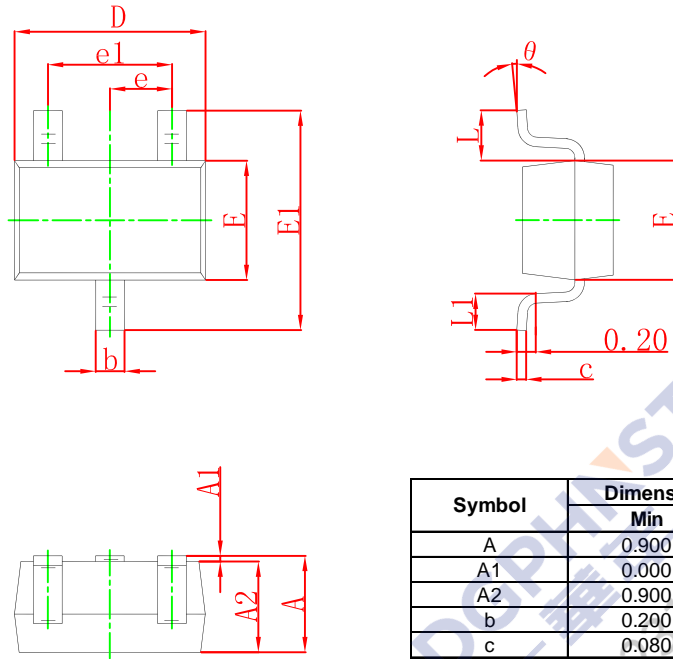

Symbol	Dimensions In Millimeters		Dimensions In Inches	
	Min	Max	Min	Max
A	0.900	1.100	0.035	0.043
A1	0.000	0.100	0.000	0.004
A2	0.900	1.000	0.035	0.039
b	0.200	0.400	0.008	0.016
c	0.080	0.150	0.003	0.006
D	2.000	2.200	0.079	0.087
E	1.150	1.350	0.045	0.053
E1	2.150	2.450	0.085	0.096
e	0.650 TYP		0.026 TYP	
e1	1.200	1.400	0.047	0.055
L	0.525 REF		0.021 REF	
L1	0.260	0.460	0.010	0.018
θ	0°	8°	0°	8°

## SOT-323 Suggested Pad Layout

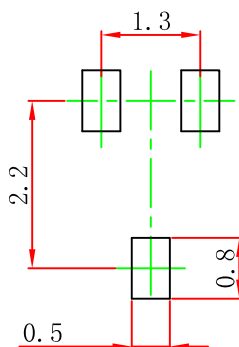

Note:

1. Controlling dimension: in millimeters.
2. General tolerance:  $\pm 0.05$  mm.
3. The pad layout is for reference purposes only.

### NOTICE

JSCJ reserves the right to make modifications, enhancements, improvements, corrections or other changes without further notice to any product herein. JSCJ does not assume any liability arising out of the application or use of any product described herein.

# SOT-323 Tape and Reel

## SOT-323 Embossed Carrier Tape

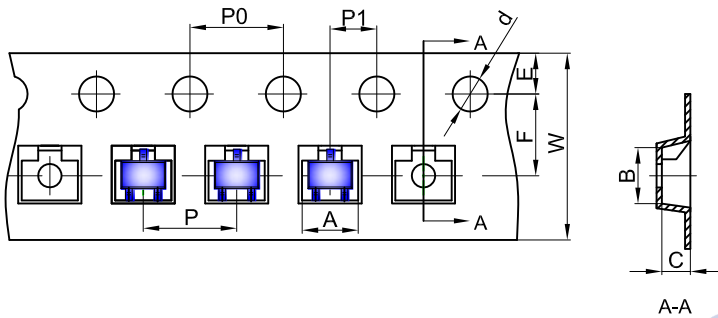

### Packaging Description:

SOT-323 parts are shipped in tape. The carrier tape is made from a dissipative (carbon filled) polycarbonate resin. The cover tape is a multilayer film (Heat Activated Adhesive in nature) primarily composed of polyester film, adhesive layer, sealant, and anti-static sprayed agent. These reeled parts in standard option are shipped with 3,000 units per 7" or 17.8cm diameter reel. The reels are clear in color and is made of polystyrene plastic (anti-static coated).

Dimensions are in millimeter										
Pkg type	A	B	C	d	E	F	P0	P	P1	W
SOT-323	2.25	2.55	1.19	Ø1.55	1.75	3.50	4.00	4.00	2.00	8.00

## SOT-323 Tape Leader and Trailer

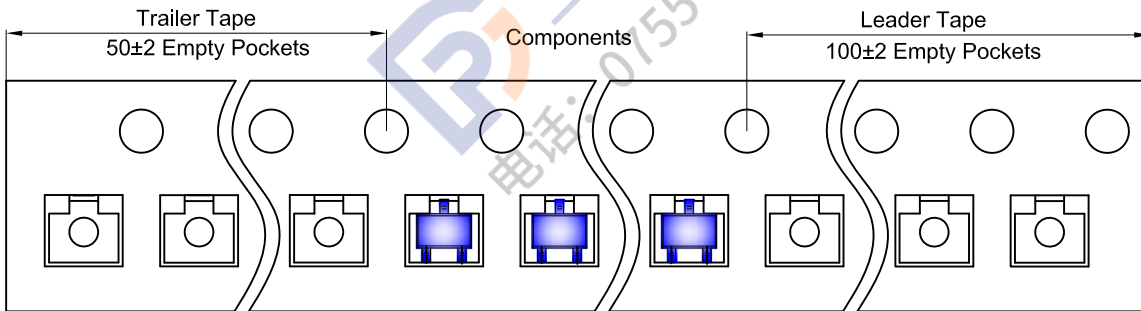

## SOT-323 Reel

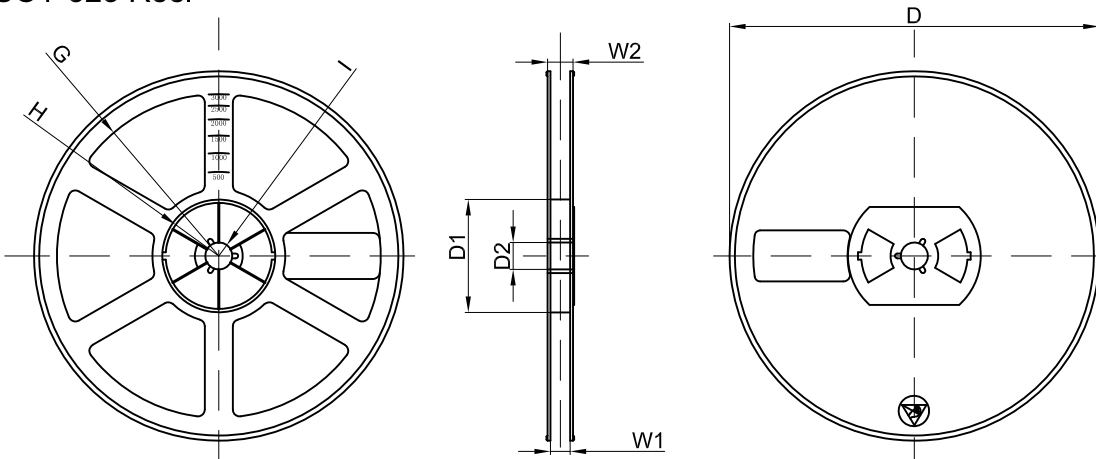

Dimensions are in millimeter								
Reel Option	D	D1	D2	G	H	I	W1	W2
7" Dia	Ø178.00	54.40	13.00	R78.00	R25.60	R6.50	9.50	12.30

REEL	Reel Size	Box	Box Size(mm)	Carton	Carton Size(mm)	G.W.(kg)
3000 pcs	7 inch	45,000 pcs	203×203×195	180,000 pcs	438×438×220	