

SOT-523 Plastic-Encapsulate Transistors

2SC4618 TRANSISTOR (NPN)

FEATURES

- High Voltage and Current
- High DC Current Gain
- Complementary to 2SC4738
- Small Package

APPLICATIONS

- General Purpose Amplification

MAXIMUM RATINGS ($T_a=25^{\circ}\text{C}$ unless otherwise noted)

| Symbol | Parameter | Value | Unit |
|-----------------|--|----------|-----------------------------|
| V_{CBO} | Collector-Base Voltage | 40 | V |
| V_{CEO} | Collector-Emitter Voltage | 25 | V |
| V_{EBO} | Emitter-Base Voltage | 5 | V |
| I_C | Collector Current | 50 | mA |
| P_C | Collector Power Dissipation | 150 | mW |
| $R_{\theta JA}$ | Thermal Resistance From Junction To Ambient | 833 | $^{\circ}\text{C}/\text{W}$ |
| T_J, T_{stg} | Operation Junction and Storage Temperature Range | -55~+150 | $^{\circ}\text{C}$ |

SOT - 523

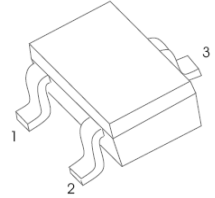

1. BASE
2. EMITTER
3. COLLECTOR

ELECTRICAL CHARACTERISTICS ($T_a=25^{\circ}\text{C}$ unless otherwise specified)

| Parameter | Symbol | Test conditions | Min | Typ | Max | Unit |
|--------------------------------------|---------------|---|-----|-----|-----|------|
| Collector-base breakdown voltage | $V_{(BR)CBO}$ | $I_C=50\mu\text{A}, I_E=0$ | 40 | | | V |
| Collector-emitter breakdown voltage | $V_{(BR)CEO}$ | $I_C=1\text{mA}, I_B=0$ | 25 | | | V |
| Emitter-base breakdown voltage | $V_{(BR)EBO}$ | $I_E=50\mu\text{A}, I_C=0$ | 5 | | | V |
| Collector cut-off current | I_{CBO} | $V_{CB}=24\text{V}, I_E=0$ | | | 500 | nA |
| Emitter cut-off current | I_{EBO} | $V_{EB}=3\text{V}, I_C=0$ | | | 500 | nA |
| DC current gain | h_{FE} | $V_{CE}=6\text{V}, I_C=1\text{mA}$ | 56 | | 270 | |
| Collector-emitter saturation voltage | $V_{CE(sat)}$ | $I_C=10\text{mA}, I_B=1\text{mA}$ | | | 0.3 | V |
| Transition frequency | f_T | $V_{CE}=6\text{V}, I_C=1\text{mA}, f=100\text{MHz}$ | 150 | | | MHz |
| Collector output capacitance | C_{ob} | $V_{CB}=6\text{V}, I_E=0, f=1\text{MHz}$ | | | 2.2 | pF |

CLASSIFICATION OF h_{FE}

| RANK | N | P | Q |
|---------|----------|----------|-----------|
| RANGE | 56 - 120 | 82 - 180 | 120 - 270 |
| MARKING | AN | AP | AQ |

Typical Characteristics

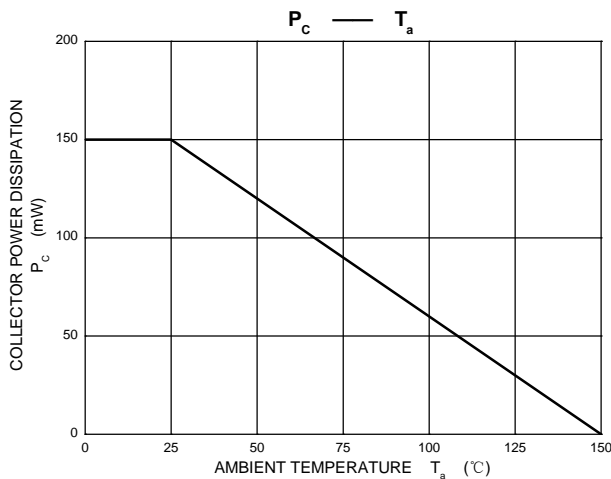
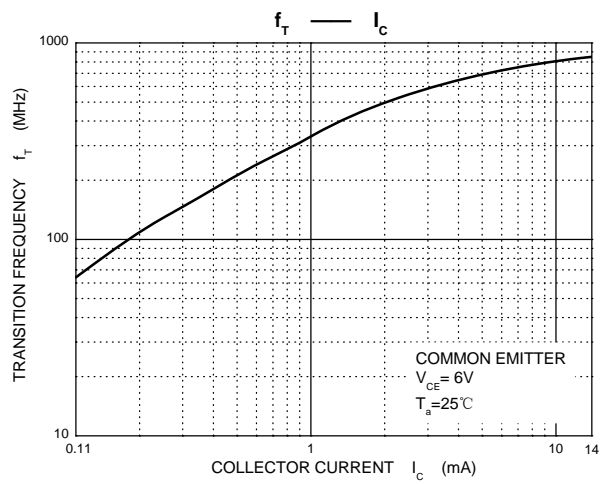
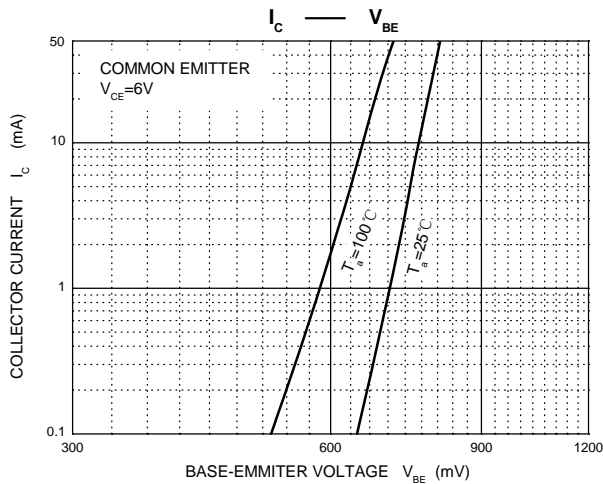
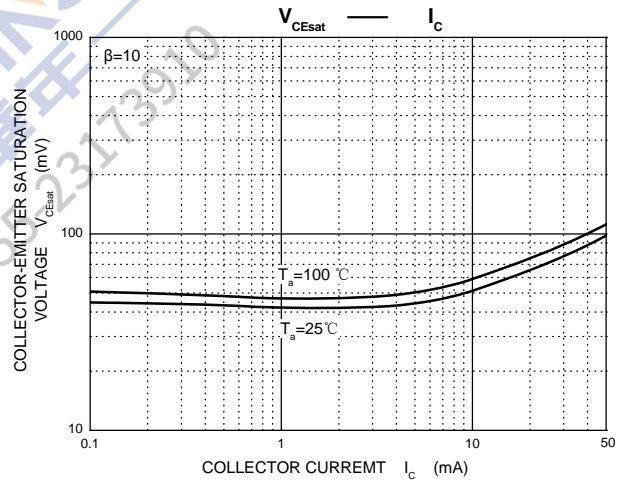
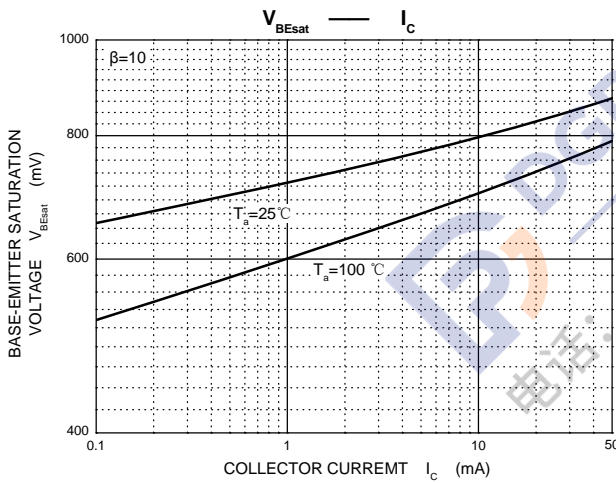
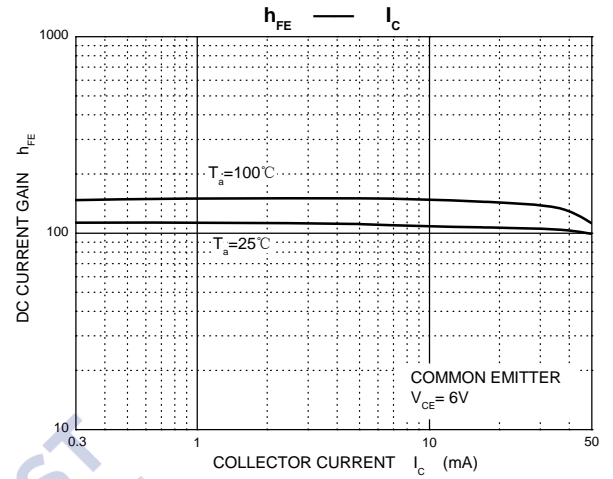
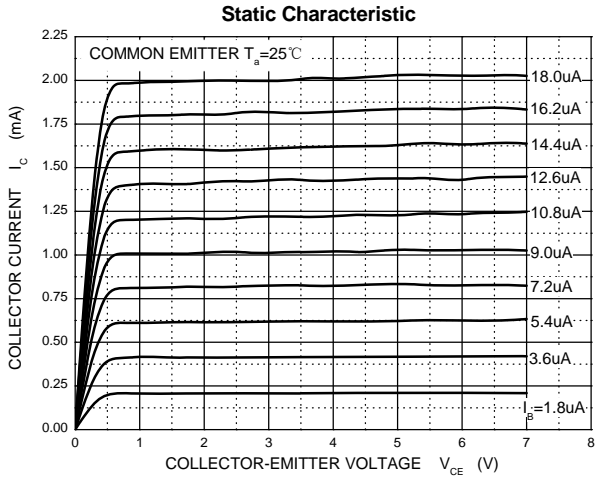

SOT-523 Package Outline Dimensions

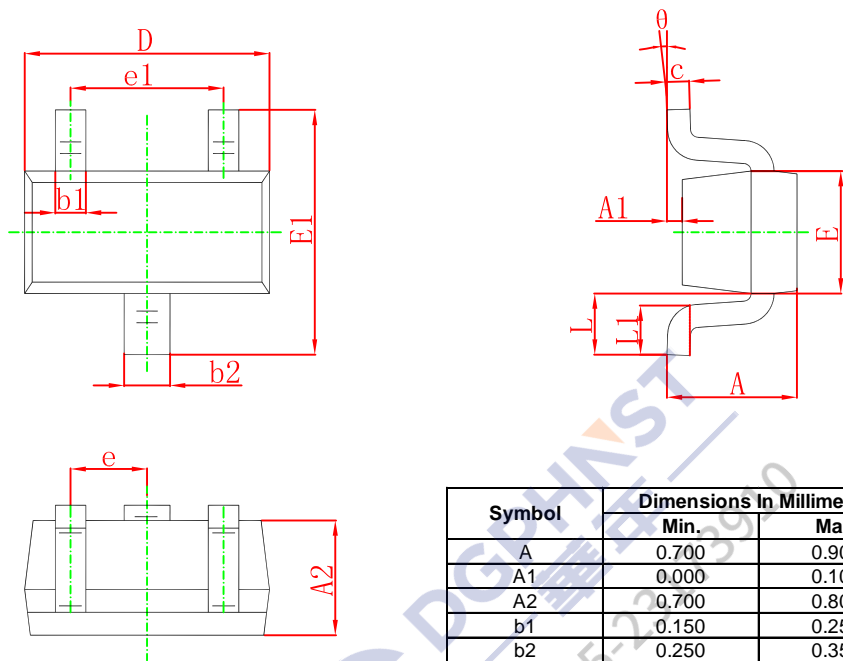

| Symbol | Dimensions In Millimeters | | Dimensions In Inches | |
|--------|---------------------------|-------|----------------------|-------|
| | Min. | Max. | Min. | Max. |
| A | 0.700 | 0.900 | 0.028 | 0.035 |
| A1 | 0.000 | 0.100 | 0.000 | 0.004 |
| A2 | 0.700 | 0.800 | 0.028 | 0.031 |
| b1 | 0.150 | 0.250 | 0.006 | 0.010 |
| b2 | 0.250 | 0.350 | 0.010 | 0.014 |
| c | 0.100 | 0.200 | 0.004 | 0.008 |
| D | 1.500 | 1.700 | 0.059 | 0.067 |
| E | 0.700 | 0.900 | 0.028 | 0.035 |
| E1 | 1.450 | 1.750 | 0.057 | 0.069 |
| e | 0.500 TYP. | | 0.020 TYP. | |
| e1 | 0.900 | 1.100 | 0.035 | 0.043 |
| L | 0.400 REF. | | 0.016 REF. | |
| L1 | 0.260 | 0.460 | 0.010 | 0.018 |
| θ | 0° | 8° | 0° | 8° |

SOT-523 Suggested Pad Layout

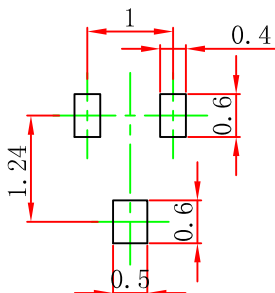

- Note:
1. Controlling dimension: in millimeters.
 2. General tolerance: $\pm 0.05\text{mm}$.
 3. The pad layout is for reference purposes only.

NOTICE

JSCJ reserves the right to make modifications, enhancements, improvements, corrections or other changes without further notice to any product herein. JSCJ does not assume any liability arising out of the application or use of any product described herein.

SOT-523 Tape and Reel

SOT-523 Embossed Carrier Tape

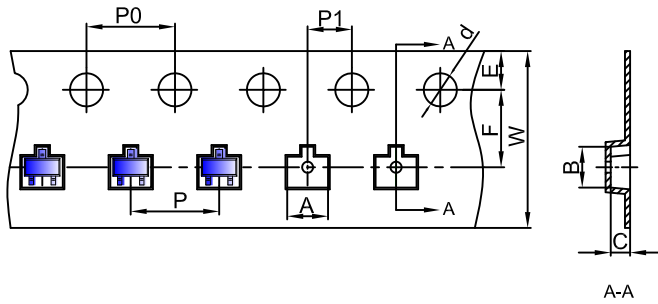

Packaging Description:

SOT-523 parts are shipped in tape. The carrier tape is made from a dissipative (carbon filled) polycarbonate resin. The cover tape is a multilayer film (Heat Activated Adhesive in nature) primarily composed of polyester film, adhesive layer, sealant, and anti-static sprayed agent. These reeled parts in standard option are shipped with 3,000 units per 7" or 17.8cm diameter reel. The reels are clear in color and is made of polystyrene plastic (anti-static coated).

Dimensions are in millimeter

| Pkg type | A | B | C | d | E | F | P0 | P | P1 | W |
|----------|------|------|-------|-------|------|------|------|------|------|------|
| SOT-523 | 1.85 | 1.85 | 0.875 | Ø1.50 | 1.75 | 3.50 | 4.00 | 4.00 | 2.00 | 8.00 |

SOT-523 Tape Leader and Trailer

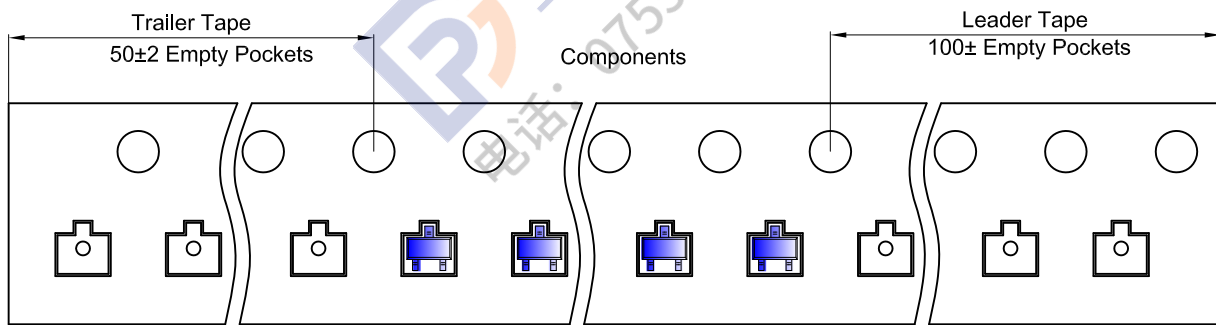

SOT-523 Reel

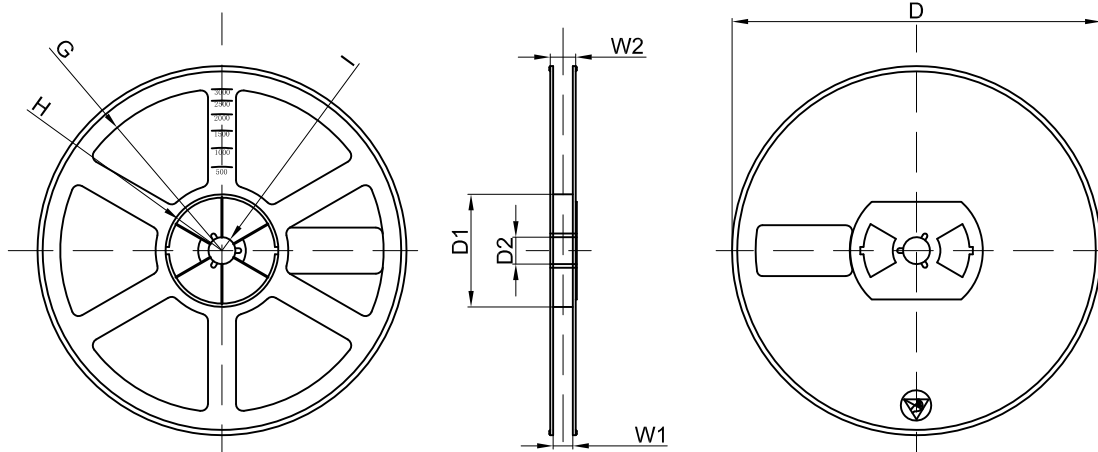

Dimensions are in millimeter

| Reel Option | D | D1 | D2 | G | H | I | W1 | W2 |
|-------------|---------|-------|-------|--------|--------|-------|------|-------|
| 7" Dia | Ø178.00 | 54.40 | 13.00 | R78.00 | R25.60 | R6.50 | 9.50 | 12.30 |

| REEL | Reel Size | Box | Box Size(mm) | Carton | Carton Size(mm) | G.W.(kg) |
|----------|-----------|------------|--------------|-------------|-----------------|----------|
| 3000 pcs | 7 inch | 45,000 pcs | 203×203×195 | 180,000 pcs | 438×438×220 | |