

## Power Thermistor for Limiting Inrush Current (NTC Thermistor)

### MF72-SCN5D-9

#### Features

- ◆ RoHS & Halogen Free (HF) compliant
- ◆ Body size:  $\Phi 9\text{mm}$
- ◆ Radial lead resin coated
- ◆ High power rating
- ◆ Wide resistance range
- ◆ Cost effective
- ◆ Operating temperature range:  $-40\sim+200^{\circ}\text{C}$
- ◆ Agency recognition: UL /cUL/RoHS



#### Recommended Applications

- ◆ Switch mode power supply
- ◆ Electric motor
- ◆ Transformer
- ◆ Adapter
- ◆ Projector
- ◆ Halogen lamp
- ◆ LED driver circuit

#### Storage Conditions of Products

- ◆ Storage Conditions:  
Storage Temperature:  $-10^{\circ}\text{C} \sim +40^{\circ}\text{C}$ .  
Relative Humidity:  $\leq 75\%RH$ .  
Keep away from corrosive atmosphere and sunlight.
- ◆ Period of Storage: 1 year.

#### Part Number Code

<b>MF72</b>	<b>SCN</b>	<b>5D</b>	<b>-</b>	<b>9</b>
(1)	(2)	(3)	(4)	

- (1) MF72: MF72 Series.
- (2) SCN: Socay NTC.
- (3) 5D: Zero Power Resistance at  $25^{\circ}\text{C}$  ( $R_{25}$ ):  $5=5\Omega$ .
- (4) Body Size:  $9=\Phi 9\text{mm}$ .

## Power Thermistor for Limiting Inrush Current (NTC Thermistor)

**MF72-SCN5D-9**

### Electrical Characteristics

Part Number	Resistance at 25°C ±20%	Max. Permissible Working Current	Resistance under Load (mΩ)	Dissipation Factor	Thermal Time Constant	Maximum permissible capacitance @240Vac
	R <sub>25</sub> (Ω)	I <sub>max</sub> (A)	(mΩ)	δ(mW/°C)	τ(Sec.)	C(μF)
MF72-SCN5D-9	5	3	210	11	34	110

### Maximum Power Rating (Pmax)

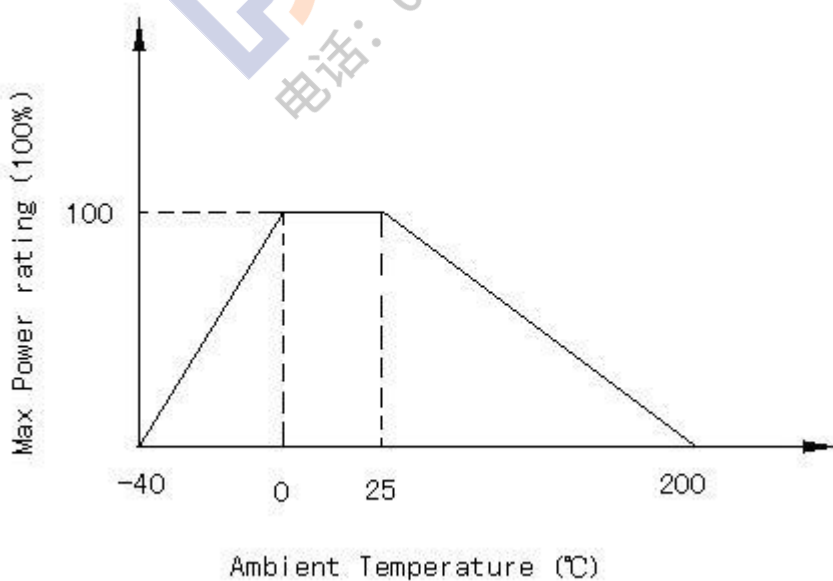

## Power Thermistor for Limiting Inrush Current (NTC Thermistor)

**MF72-SCN5D-9**

### Structure and Dimensions (Unit: mm)

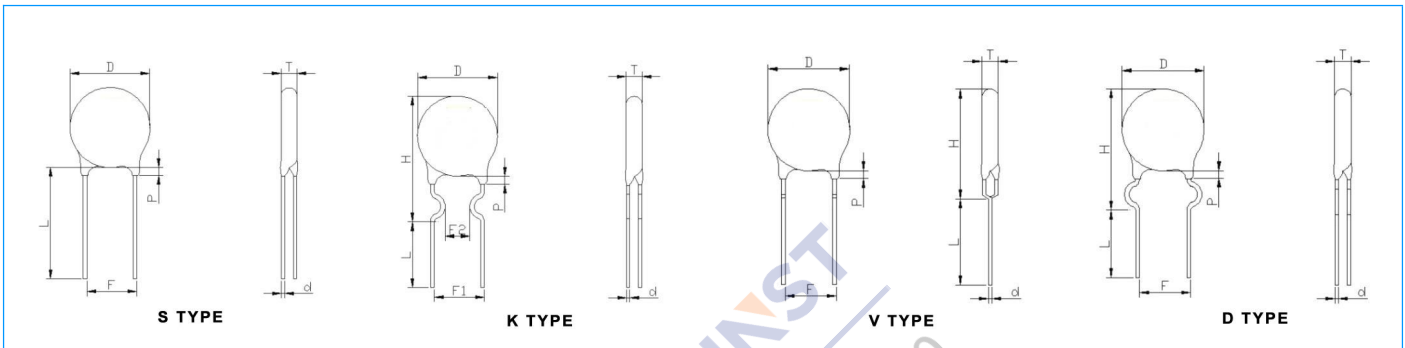

D max	T max	P max	F	H	L <sub>short</sub> /L <sub>long</sub>	d	Type
10.5	5.5	3.0	7.5±0.5	--	7±1/20±1	0.75	S
10.5	5.5	3.0	7.5±0.5	16.5±1	4±1/20±1	0.75	K/V/D

Note: Length of Pin (L) can be customized.

### Packing Specification

Part Number	Type of L	Quantity (pcs/bag)
MF72-SCN5D-9	L <sub>short</sub>	1000
	L <sub>long</sub>	500

### Reliability

Item	Test conditions / Methods	Test Result
<b>Tensile Strength of Terminals</b>	Fasten body with a Load Applied to each lead 3.0Kg for 1sec.	No break out and damage
<b>Bending Strength of Terminals</b>	Fixed body hand 1.0kg on one terminal bend 90 then back again oppsite.	No break out and damage
<b>Solder Ability</b>	When the Lead wire was dipped into bath of 235 ± 5 °C for 3 seconds after immersion in 25% rosin flux the solder ability ratio of lead wire surface should more than 95%.	More than 95% solder ability
<b>Temp. Cycle Test</b>	(-40°C×→+25°C×3min) × 5Cycles (-85°C×→+25°C×3min) × 5Cycles	ΔR/R   ≤ ± 20 %
<b>Humidity Test</b>	45°C 95%RH×1000 hours	ΔR/R   ≤ ± 20 %
<b>Load Life</b>	6 AMP×1000 hours	ΔR/R   ≤ ± 20 %
<b>Insulation Test</b>	DC 700V	R≥500MΩ