



# Application Notes: AN\_SY6875A

## Programmable Current Limit Switch

### General Description

SY6875A is a programmable current limit switch with input voltage range selection and output voltage clamping. Extremely low  $R_{DS(ON)}$  of the integrated protection N-channel FET helps to reduce power loss during the normal operation. Programmable soft-start time controls the slew rate of the output voltage during the start-up time. Independent enable control allows the complicated system sequencing control. It integrates the over-temperature protection shutdown and auto-recovery with hysteresis. This IC along with small DFN3X3-10 footprint provides small PCB area application.

### Features

- Wide Input Voltage Range from 2.5V to 15V with surge up to 30V
- Extremely Low  $R_{DS(ON)}$  for the Integrated Protection Switch: 40 m $\Omega$
- Programmable Soft-Start Time
- Programmable Current Limit
- Short-circuit Protection
- Selectable Input Range and Clamping Output Voltage Threshold.
- Enable Interface Pin
- Thermal Shutdown Protection & Auto Recovery
- RoHS Compliant and Halogen Free
- Compact package: DFN3X3-10

### Ordering Information

SY6875  $\square(\square)\square$   
 Temperature Code  
 Package Code  
 Optional Spec Code

Ordering Number	Package type	Note
SY6875ADBC	DFN3x3-10	----

### Applications

- Notebook PC
- I-pad Mini
- Server
- Service PC

### Typical Applications

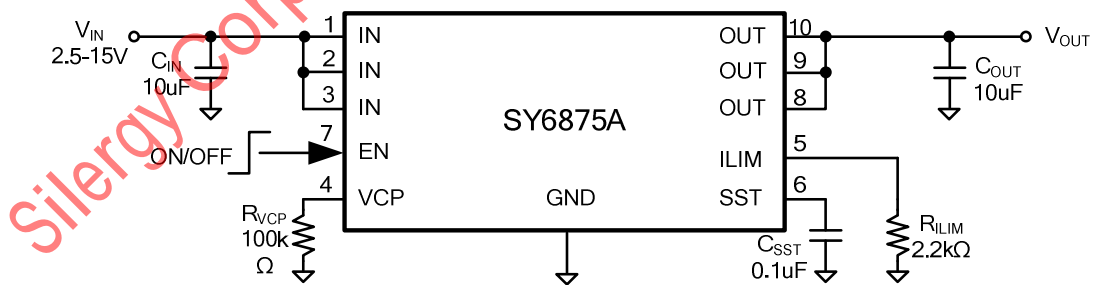
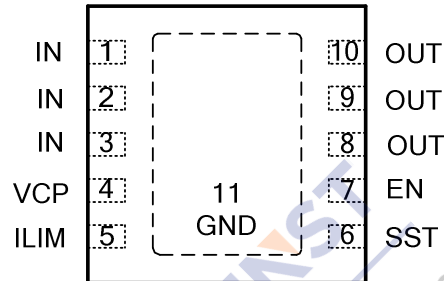

Figure 1. Schematic Diagram

## Pinout (top view)



(DFN3x3-10)

Top mark: FNxyz for SY6875A (Device code: FN, x=year code, y=week code, z=lot number code)

Pin Name	Pin Number	Pin Description																											
IN	1,2,3	Power input pin. Decouple high frequency noise by connecting at least 0.1uF MLCC to ground.																											
GND	11(exposed paddle)	Ground pin.																											
OUT	8,9,10	Power output pin.																											
ILIM	5	Current limit program pin. Program the current limit by connecting a resistor to ground.																											
SST	6	Soft-start time program pin. Connect a capacitor to ground to program the soft start time.																											
EN	7	Enable interface pin. Pull it High to enable the IC.																											
VCP	4	Output clamp voltage selection based on the input voltage. Pull VCP pin to High by connecting a resistor to IN, or pull VCP pin to Low by connecting a resistor to ground, or float VCP Pin to select different output clamping thresholds. Recommend to decoupling this pin with 0.1uF capacitor.																											
		<table border="1"> <thead> <tr> <th rowspan="2">VCP</th> <th colspan="2" rowspan="2">IN</th> <th colspan="3">Clamping Threshold</th> </tr> <tr> <th>Min</th> <th>Typ</th> <th>Max</th> </tr> </thead> <tbody> <tr> <td>Low</td> <td>3.3V</td> <td>Over 4V</td> <td>3.6V</td> <td>3.8V</td> <td>4.0V</td> </tr> <tr> <td>High</td> <td>5V</td> <td>Over 6V</td> <td>5.4V</td> <td>5.7V</td> <td>6.0V</td> </tr> <tr> <td>Open</td> <td>12V</td> <td>Over 14V</td> <td>12.6V</td> <td>13.3V</td> <td>14V</td> </tr> </tbody> </table>	VCP	IN		Clamping Threshold			Min	Typ	Max	Low	3.3V	Over 4V	3.6V	3.8V	4.0V	High	5V	Over 6V	5.4V	5.7V	6.0V	Open	12V	Over 14V	12.6V	13.3V	14V
VCP	IN					Clamping Threshold																							
			Min	Typ	Max																								
Low	3.3V	Over 4V	3.6V	3.8V	4.0V																								
High	5V	Over 6V	5.4V	5.7V	6.0V																								
Open	12V	Over 14V	12.6V	13.3V	14V																								

## Block Diagram

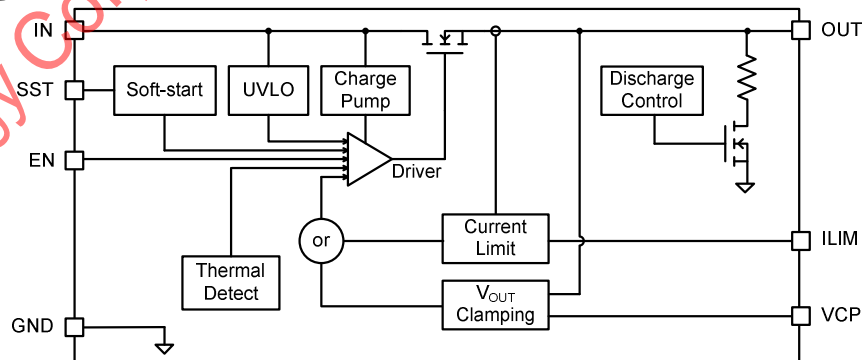



**Absolute Maximum Ratings** (Note 1)

Supply Input Voltage	-----	30V
EN pin, VCP pin,	-----	30V
Power Dissipation, P <sub>D</sub> @ T <sub>A</sub> = 25°C DFN3X3-10,	-----	2.6W
Package Thermal Resistance (Note 2)		
θ <sub>JA</sub>	-----	38°C/W
θ <sub>JC</sub>	-----	8°C/W
Junction Temperature Range	-----	125°C
Lead Temperature (Soldering, 10 sec.)	-----	260°C
Storage Temperature Range	-----	-65°C to 150°C

**Recommended Operating Conditions** (Note 3)

Supply Input Voltage	-----	2.5V to 15V
Junction Temperature Range	-----	-40°C to 125°C
Ambient Temperature Range	-----	40°C to 85°C

**Electrical Characteristics**

(V<sub>IN</sub> = 5V, R<sub>LIM</sub>=10kΩ, C<sub>SST</sub>=105nF, C<sub>IN</sub> = 10uF, C<sub>OUT</sub> = 10uF, T<sub>A</sub> = 25°C, unless otherwise specified )

Parameter	Symbol	Test Conditions	Min	Typ	Max	Unit
Input Voltage Range	V <sub>IN</sub>		2.5		30	V
Input UVLO Threshold	V <sub>UVLO</sub>	VCP=LOW	2.2		2.4	V
		VCP=HIGH	3.4		3.8	V
		VCP=OPEN	8.1		9.0	V
UVLO hysteresis	V <sub>HYS</sub>	VCP=LOW	0.05	0.085	0.13	V
		VCP=HIGH	0.06	0.095	0.15	
		VCP=OPEN	0.1	0.19	0.29	
Bias Current	I <sub>BIAS</sub>			200		μA
Shutdown Current	I <sub>SHDN</sub>	EN=0		10		μA
Protection FET RON	R <sub>DS(ON)</sub>			40	70	mΩ
Current Limit Accuracy				± 30% I <sub>LIM</sub>		
Current Limit Program Range	I <sub>LIM</sub>	(Note 5)	1		5	A
Clamping Output Voltage	V <sub>CLP</sub>	VCP=LOW	3.6	3.8	4.0	V
		VCP=HIGH	5.4	5.7	6.0	V
		VCP=OPEN	12.6	13.3	14.0	V
Soft-start Time	T <sub>SST</sub>	C <sub>SST</sub> =105nF(Note 4)		29.4		ms
Soft-start Time Accuracy				± 30% T <sub>SST</sub>		
EN Turn-on Threshold	V <sub>EN_ON</sub>		2			V
EN Turn-off Threshold	V <sub>EN_OFF</sub>				0.4	V
Output Discharge Resistor	R <sub>DIS</sub>	EN='0'		30		Ω
Thermal Shutdown Temperature	T <sub>SD</sub>			140		°C
Thermal Shutdown Hysteresis	T <sub>HYS</sub>			20		°C

**Note 1:** Stresses beyond “Absolute Maximum Ratings” may cause permanent damage to the device. These are for stress ratings. Functional operation of the device at these or any other conditions beyond those indicated in the operational sections of the specifications is not implied. Exposure to absolute maximum rating conditions may affect device reliability.



**Note 2:**  $\theta_{JA}$  is measured in the natural convection at  $T_A = 25^\circ\text{C}$  on a low effective single layer thermal conductivity test board of JEDEC 51-3 thermal measurement standard. Test condition: Device mounted on 2" x 2" FR-4 substrate PCB, 2oz copper, with minimum recommended pad on top layer and thermal vias to bottom layer ground plane.

**Note 3.** The device is not guaranteed to function outside its operating conditions

**Note4. Recommended Soft-start Time Program Table**

SST cap (nF)	None	10	55	105
Rise time (ms)	1.4	2.8	15.4	29.4

Recommended Formula for  $C_{SST}$  & Soft-start Time Calculation

$$T_{SS} = \begin{cases} T_{SS\_DLT}, & \text{No external } C_{SST} \\ \frac{C_{SST}}{I_{INT}}, & T_{SS} > T_{SS\_DLT} \end{cases}$$

Where,  $T_{SS\_DLT}$  is the internally fixed default soft-start time, about 1.4ms, which means there's no any external  $C_{SST}$ ;  $I_{INT}$  is the internal current source, about 3.6uA.

**Note5. Recommended Current Limit Program Table**

Current Limit Resistance (kΩ)	11	5.5	4.4	3.7	3.1	2.8	2.4	2.2
Current Limit (A)	1.0	2.0	2.5	3.0	3.5	4.0	4.5	5.0

Recommended Formula for  $R_{LIM}$  & Current Limit Calculation

$$R_{LIM} = \frac{11k}{I_{LIM}} (\Omega).$$

## Typical Performance Characteristics

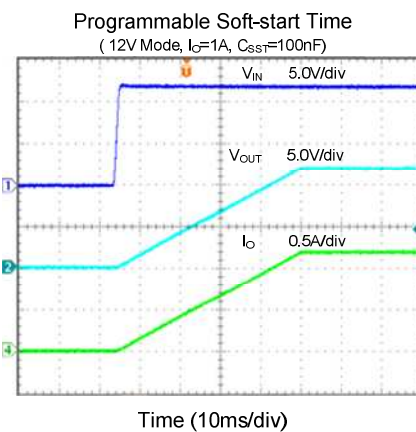
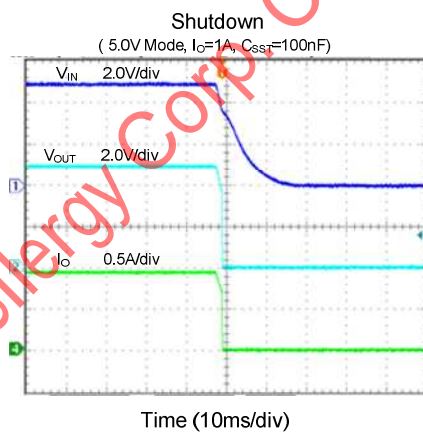
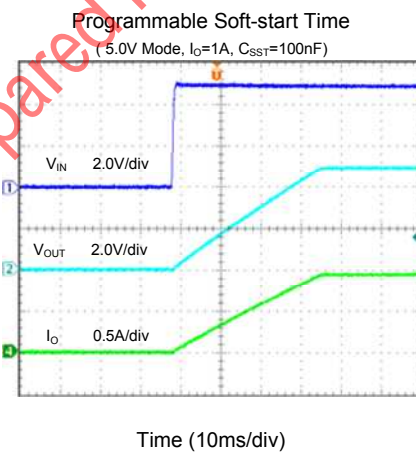
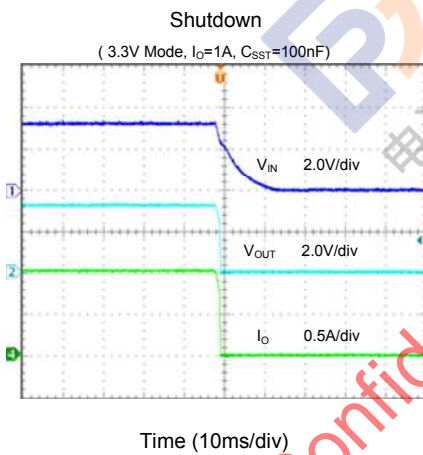
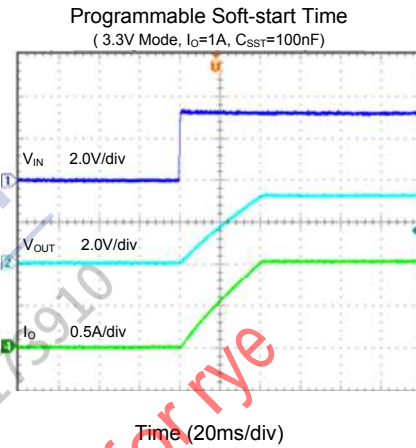
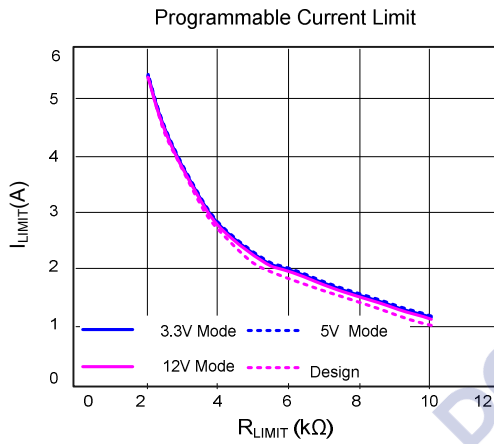

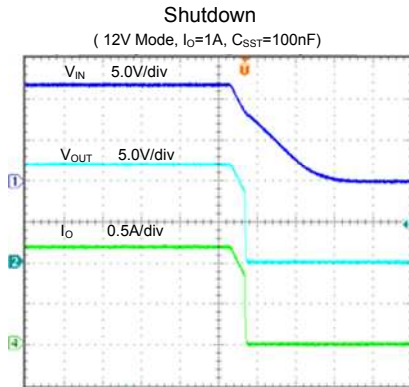

Time (10ms/div)

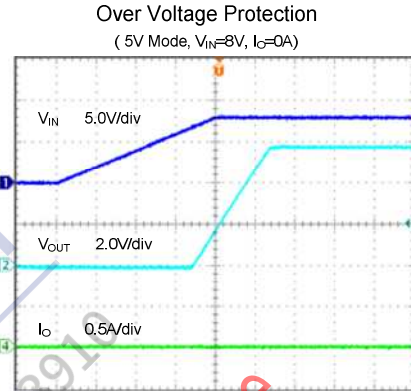

Time (20ms/div)

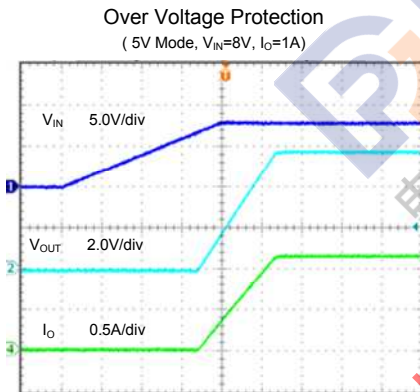

Time (20ms/div)

### PCB Layout Guideline

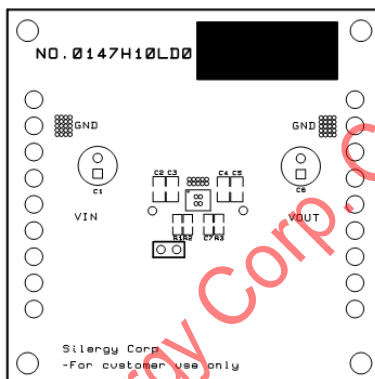
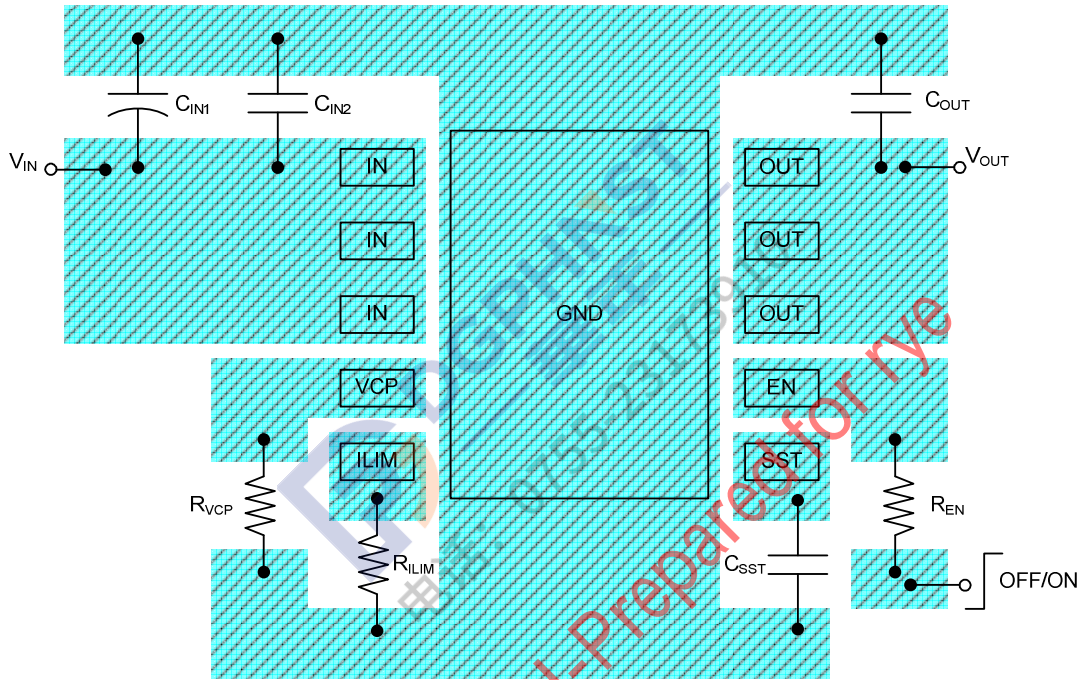

Top Silkscreen

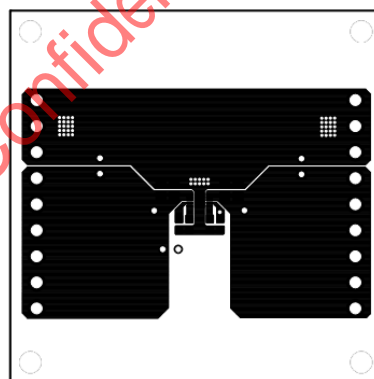

Top Layer

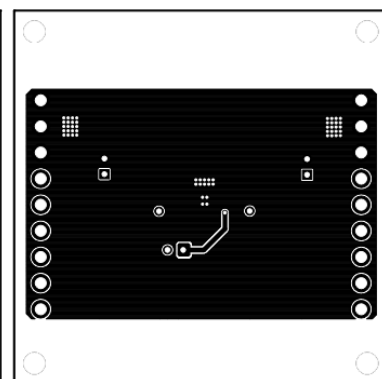

Bottom Layer

DFN3x3-10 Package outline

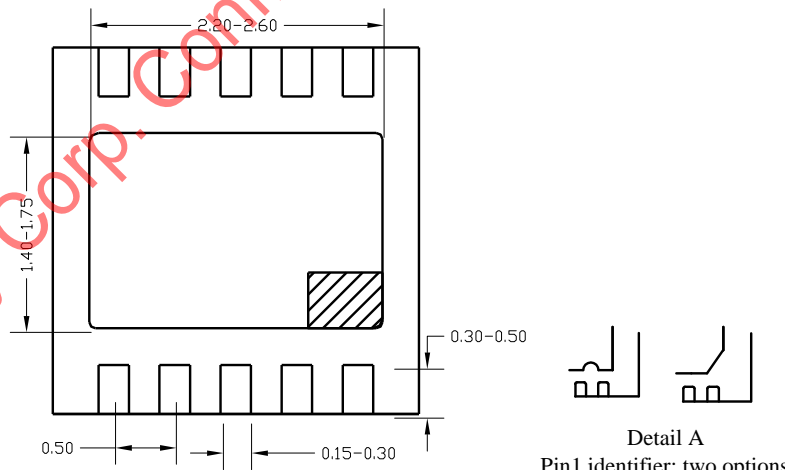
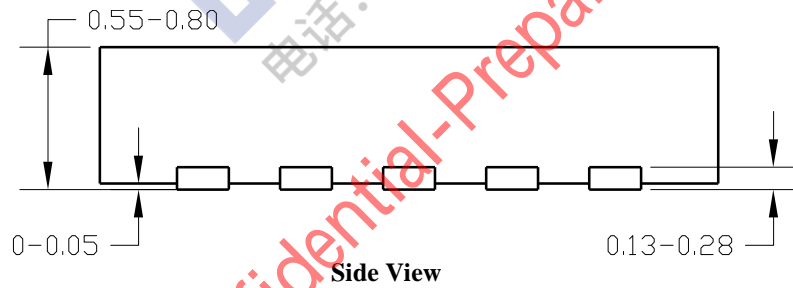
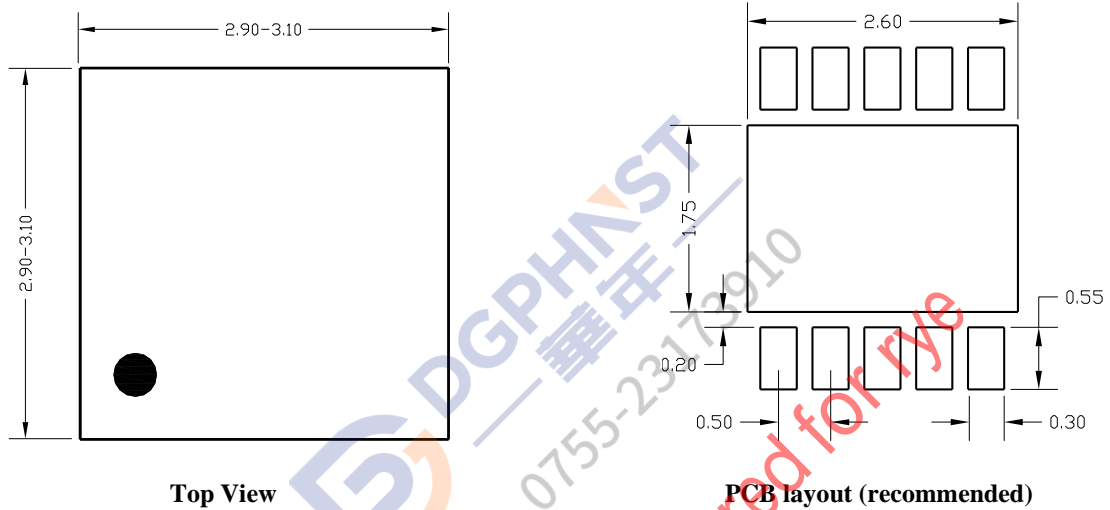

**Notes: All dimensions are in millimeters and exclude mold flash & metal burr.**



## Taping & Reel Specification

### 1. DFN3x3-10 taping orientation

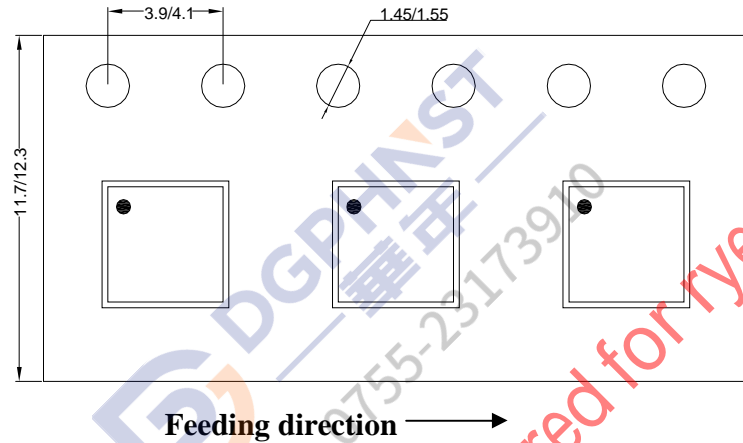

### 2. Carrier Tape & Reel specification for packages

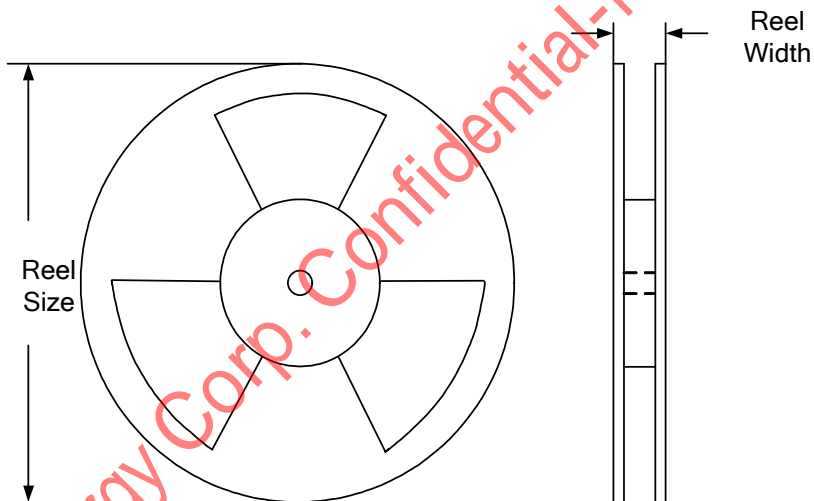

Package types	Tape width (mm)	Pocket pitch(mm)	Reel size (Inch)	Reel width(mm)	Trailer length(mm)	Leader length (mm)	Qty per reel
DFN3x3	10	8	13"	12.4	400	400	5000

### 3. Others: NA