

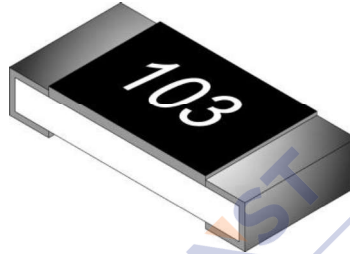

# AS Series Thick Film Anti-Surge Chip Resistor Product Specifications

Document No.	S-10-12-47-05
Released Date	2021/08/16
Page No.	1/13

## Thick Film Anti-Surge Chip Resistor — AS Series



### Application

- Metering(Testing/Measurement)
- Medical Devices
- Automotive
- Power supply
- Charger
- Inverter
- LCD Video Monitors

### Features

- High power rating
- Improved working voltage ratings
- Standard package sizes of 0402~2512
- excellent Anti-Pulse ability (Tolerance 1%&2%)
- excellent Anti-Surge ability (Tolerance 5%&10%&20%&30%)
- AEC-Q200 Compliant

## Parts Number Explanation

Example:

AS	0603	J	10R0	P	05	Z
Product Type	Size (Inch)	Resistor Tolerance	Resistor Value	Package	Quantity	Optional
AS	0402 0603 0805 1206 1210 2010 2512	F : ±1% G : ±2% J : ±5% K : ±10% M : ±20% N : ±30%	1R=1R00 10R=10R0 100R=100R 1K=1K00 1M=1M00	P : Paper Taping (0603~1210) Q : Paper Taping (0201、0402) E : Embossed Taping	04 : 4000PCS 05 : 5000PCS 10 : 10000PCS 40 : 40000PCS 50 : 50000PCS	Z : Type-1 Normal Type  H : Type-2 High Power



## AS Series Thick Film Anti-Surge Chip Resistor Product Specifications

Document No.	S-10-12-47-05
Released Date	2021/08/16
Page No.	2/13

### ■ Standard Electrical Specifications Type-1

Item Type-1	Rated Power at 70°C	Max Working Voltage	Max Overload Voltage	T.C.R. (PPM/°C)	Resistance Range		
					F(±1%) G(±2%)	J(±5%) K(±10%)	M(±20%) N(±30%)
AS0402	0.1 W	50V	100V	±400	-	1Ω ≤ R < 10Ω	
				±300	-	10Ω ≤ R < 1KΩ	
				±200	10Ω ≤ R ≤ 1MΩ	1KΩ ≤ R ≤ 10MΩ	
AS0603	0.125 W	150V	200V	±400	-	1Ω ≤ R < 10Ω	
				±200	-	-	10Ω ≤ R ≤ 10MΩ
				±100	10Ω ≤ R ≤ 1MΩ	10Ω ≤ R ≤ 10MΩ	-
AS0805	0.25 W	150V	300V	±400	-	1Ω ≤ R < 10Ω	
				±200	-	-	10Ω ≤ R ≤ 10MΩ
				±100	10Ω ≤ R ≤ 1MΩ	10Ω ≤ R ≤ 10MΩ	-
AS1206	0.33 W	200V	400V	±400	-	1Ω ≤ R < 10Ω	
				±200	-	-	10Ω ≤ R ≤ 10MΩ
				±100	10Ω ≤ R ≤ 1MΩ	10Ω ≤ R ≤ 10MΩ	-
AS1210	0.5 W			±400	-	1Ω ≤ R < 10Ω	
				±200	-	-	10Ω ≤ R ≤ 10MΩ
				±100	10Ω ≤ R ≤ 1MΩ	10Ω ≤ R ≤ 10MΩ	-
AS2010	0.75 W	400V	800V	±400	-	1Ω ≤ R < 10Ω	
				±200	-	-	10Ω ≤ R ≤ 10MΩ
				±150	10Ω ≤ R ≤ 1MΩ	10Ω ≤ R ≤ 10MΩ	-
AS2512	1.5 W	500V	1000V	±400	-	1Ω ≤ R < 10Ω	
				±200	-	-	10Ω ≤ R ≤ 10MΩ
				±150	10Ω ≤ R ≤ 1MΩ	10Ω ≤ R ≤ 10MΩ	-

- For non-standard parts, please contact our sales dept.
- Operating Temperature Range : -55°C ~ +155°C.



## AS Series Thick Film Anti-Surge Chip Resistor Product Specifications

Document No.	S-10-12-47-05
Released Date	2021/08/16
Page No.	3/13

### ■ High Power Rating Electrical Specifications Type-2

Item Type-2	Rated Power at 70°C	Max Working Voltage	Max Overload Voltage	T.C.R. (PPM/°C)	Resistance Range		
					F(±1%) G(±2%)	J(±5%) K(±10%)	M(±20%) N(±30%)
AS0402	0.125W	50V	100V	±400	-	1Ω ≤ R < 10Ω	
				±300	-	10Ω ≤ R < 1KΩ	
				±200	10Ω ≤ R ≤ 1MΩ	1KΩ ≤ R ≤ 10MΩ	
AS0603	0.25 W	150V	200V	±400	-	1Ω ≤ R < 10Ω	
				±200	-	-	10Ω ≤ R ≤ 10MΩ
				±100	10Ω ≤ R ≤ 1MΩ	10Ω ≤ R ≤ 10MΩ	-
AS0805	0.4 W	150V	300V	±400	-	1Ω ≤ R < 10Ω	
				±200	-	-	10Ω ≤ R ≤ 10MΩ
				±100	10Ω ≤ R ≤ 1MΩ	10Ω ≤ R ≤ 10MΩ	-
AS1206	0.5 W	200V	400V	±400	-	1Ω ≤ R < 10Ω	
				±200	-	-	10Ω ≤ R ≤ 10MΩ
				±100	10Ω ≤ R ≤ 1MΩ	10Ω ≤ R ≤ 10MΩ	-
AS1210	0.75 W			±400	-	1Ω ≤ R < 10Ω	
				±200	-	-	10Ω ≤ R ≤ 10MΩ
				±100	10Ω ≤ R ≤ 1MΩ	10Ω ≤ R ≤ 10MΩ	-
AS2010	1 W	400V	800V	±400	-	1Ω ≤ R < 10Ω	
				±200	-	-	10Ω ≤ R ≤ 10MΩ
				±150	10Ω ≤ R ≤ 1MΩ	10Ω ≤ R ≤ 10MΩ	-
AS2512	2 W	500V	1000V	±400	-	1Ω ≤ R < 10Ω	
				±200	-	-	10Ω ≤ R ≤ 10MΩ
				±150	10Ω ≤ R ≤ 1MΩ	10Ω ≤ R ≤ 10MΩ	-

- For non-standard parts, please contact our sales dept.
- Operating Temperature Range : -55°C ~ +155°C



# AS Series Thick Film Anti-Surge Chip Resistor Product Specifications

Document No.	S-10-12-47-05
Released Date	2021/08/16
Page No.	4/13

## Lightning Surge:

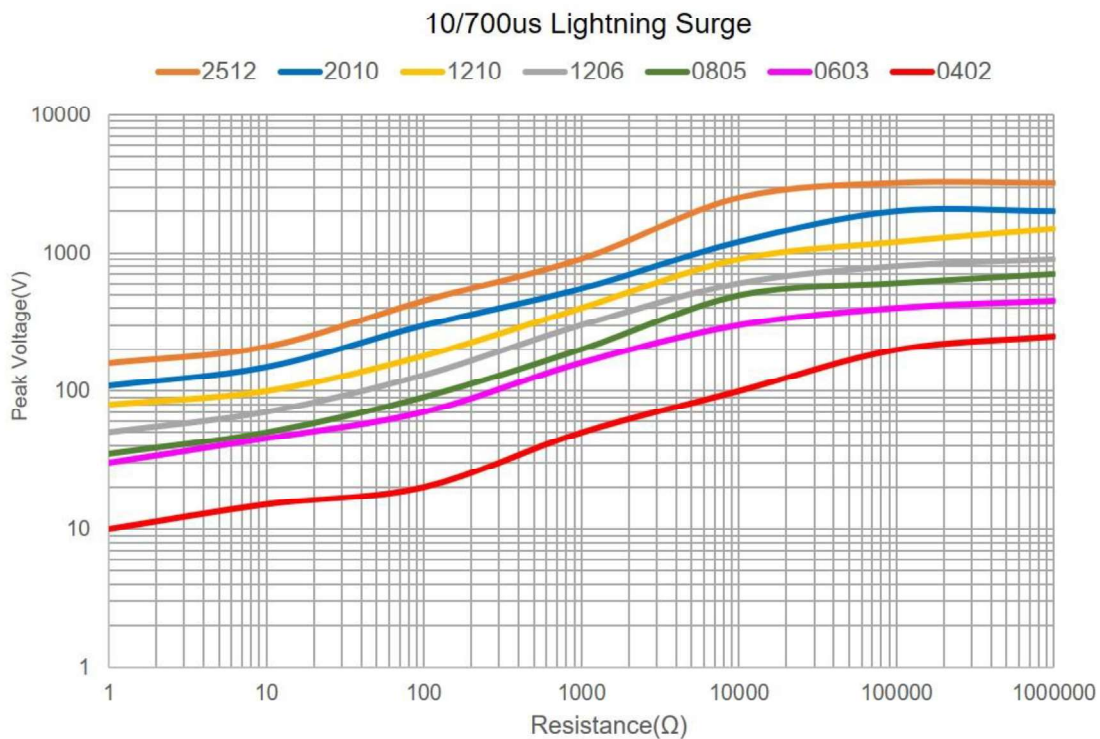
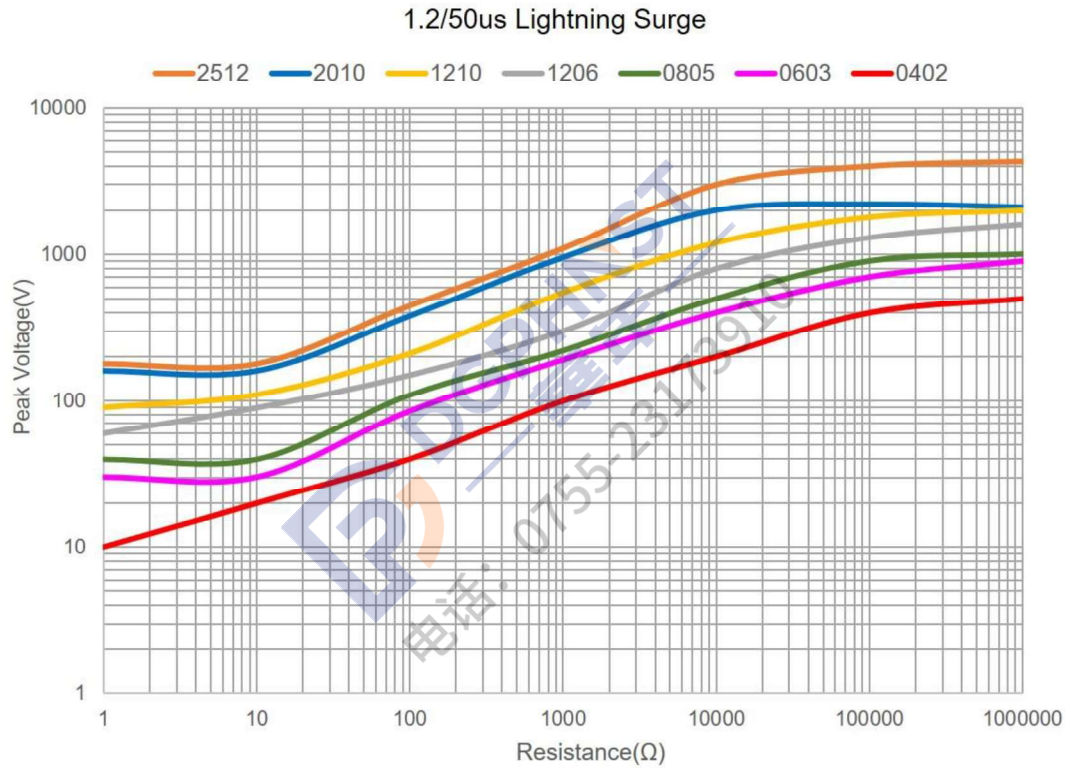



# AS Series Thick Film Anti-Surge Chip Resistor Product Specifications

Document No.	S-10-12-47-05
Released Date	2021/08/16
Page No.	5/13

## Single Pulse Power:

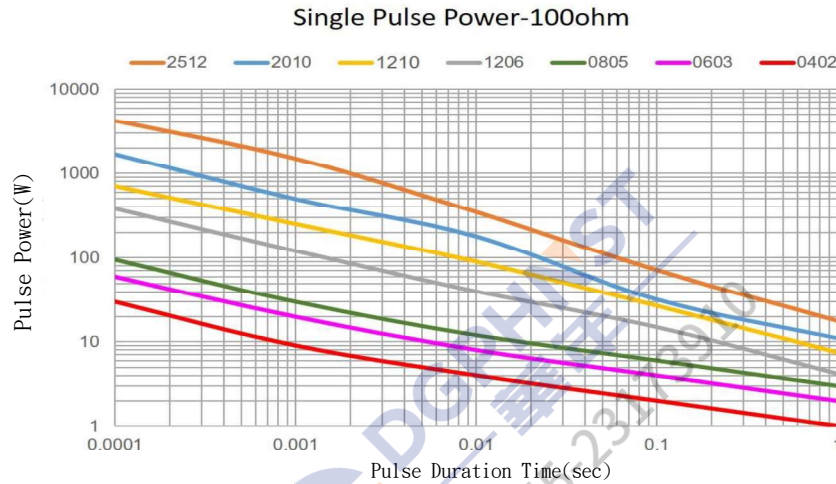

## Continuous Pulse Power:

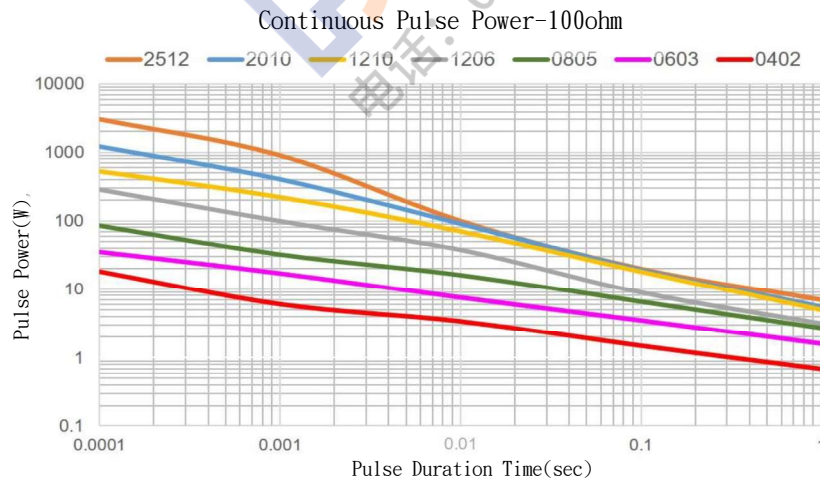

## Pulse Voltage:

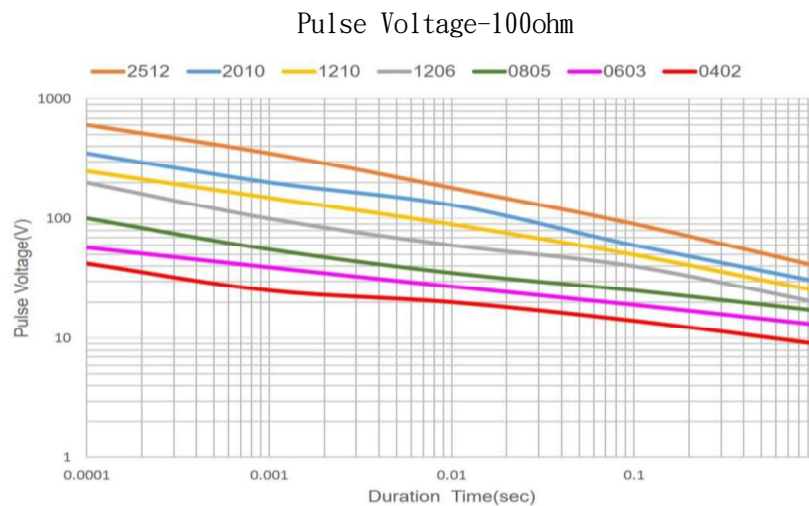

## ■ Type Dimension

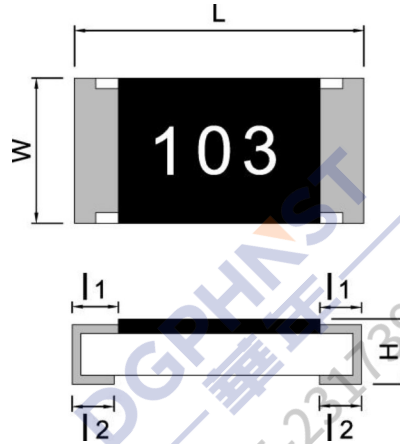

AS0402 / AS0603 / AS0805 / AS1206 / AS1210 / AS2010 / AS2512

TYPE-1	L	W	H	l <sub>1</sub>	l <sub>2</sub>
AS0402	1.00 ± 0.05	0.50 ± 0.05	0.30 ± 0.05	0.15 ± 0.10	0.20 ± 0.10
AS0603	1.60 ± 0.10	0.80 ± 0.10	0.40 ± 0.10	0.30 ± 0.20	0.30 ± 0.10
AS0805	2.00 ± 0.10	1.25 ± 0.10	0.50 ± 0.15	0.30 ± 0.15	0.40 ± 0.15
AS1206	3.05 ± 0.10	1.60 ± 0.10	0.55 ± 0.15	0.40 ± 0.20	0.50 ± 0.20
AS1210	3.05 ± 0.10	2.50 ± 0.15	0.55 ± 0.15	0.50 ± 0.20	0.50 ± 0.20
AS2010	5.00 ± 0.20	2.50 ± 0.15	0.55 ± 0.10	0.60 ± 0.20	0.60 ± 0.20
AS2512	6.30 ± 0.20	3.20 ± 0.15	0.68 ± 0.10	0.60 ± 0.20	0.60 ± 0.20

TYPE-2	L	W	H	l <sub>1</sub>	l <sub>2</sub>
AS0402	1.00 ± 0.05	0.50 ± 0.05	0.30 ± 0.05	0.15 ± 0.10	0.20 ± 0.10
AS0603	1.60 ± 0.10	0.80 ± 0.10	0.40 ± 0.10	0.30 ± 0.20	0.30 ± 0.10
AS0805	2.00 ± 0.10	1.25 ± 0.10	0.50 ± 0.15	0.30 ± 0.15	0.40 ± 0.15
AS1206	3.05 ± 0.10	1.60 ± 0.10	0.55 ± 0.15	0.40 ± 0.20	0.50 ± 0.20
AS1210	3.05 ± 0.10	2.50 ± 0.15	0.55 ± 0.15	0.50 ± 0.20	0.50 ± 0.20
AS2010	5.00 ± 0.20	2.50 ± 0.15	0.55 ± 0.10	0.60 ± 0.20	0.60 ± 0.20
AS2512	6.30 ± 0.20	3.20 ± 0.15	0.68 ± 0.10	0.60 ± 0.20	0.60 ± 0.20



# AS Series Thick Film Anti-Surge Chip Resistor Product Specifications

Document No.	S-10-12-47-05
Released Date	2021/08/16
Page No.	7/13

## ● General Information

### ■ Recommend Land Pattern Design

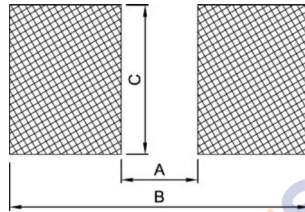

### ■ Dimension

Unit:mm

Type	0402	0603	0805	1206	1210	2010	2512
A	0.60	0.80	1.30	2.20	2.00	3.80	4.90
B	1.60	2.40	2.90	4.20	4.40	6.60	8.10
C	0.70	1.00	1.40	1.70	2.70	2.70	3.40

## ■ Performance Characteristics

### ■ Power Derating Curve

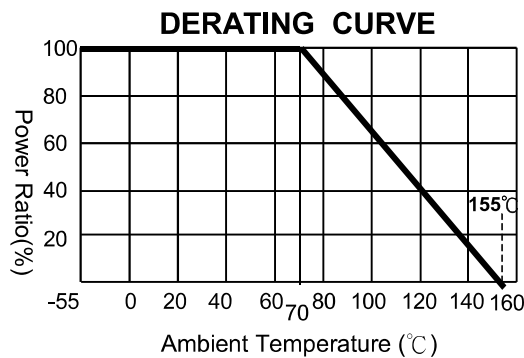

Power rating or current rating is in the case based on continuous full-load at ambient temperature of 70°C. For operation at ambient temperature in excess of 70°C, the load should be derated in accordance with figure of derating Curve.

### ■ Voltage Rating or Current Rating

Resistance Range:  $\geq 1\Omega$

Rated Voltage: The resistor shall have a DC continuous working voltage or a RMS AC continuous working voltage at commercial-line frequency and wave form corresponding to the power rating, as determined formula as following:

$$E(RCWV) = \sqrt{P \times R}$$

E=Rated voltage(V)

P=Power rating(W)

R=Nominal resistance( $\Omega$ )



## AS Series Thick Film Anti-Surge Chip Resistor Product Specifications

Document No.	S-10-12-47-05
Released Date	2021/08/16
Page No.	8/13

### ● Reliability Test and Requirement

Test Item	Test Method	Procedure	Requirements
Temperature Coefficient of Resistance (T.C.R)	JIS-C-5201-1 4.8 IEC-60115-1 4.8	At 25°C / -55°C and 25°C / +155°C, 25°C is the reference temperature	Refer to Ratings
Short Time Overload	JIS-C-5201-1 4.13 IEC-60115-1 4.13	2.5 times RCWV or Max. Overload voltage whichever is less for 5 seconds.	±(1.0%+0.05Ω)
Single pulse high voltage overload	IEC-60115	Severity No. 4: $U = 10 \times \sqrt{P_{70} \times R}$ or $U = 2 \times U_{MAX}$ ; whichever is the less severe. One pulse per minute, 10 pulses 10 / 700 μs.	±(1.0%+0.05Ω)
Leaching	JIS-C-5201-1 4.18 IEC-60068-2-58 8.2.1	260±5°C for 30 seconds.	Individual leaching area ≤ 5% Total leaching area ≤ 10%
Resistance to Soldering Heat	JIS-C-5201-1 4.18 IEC-60115-1 4.18	260±5°C for 10 seconds.	±(1.0%+0.05Ω)
Rapid Change of Temperature	JIS-C-5201-1 4.19 IEC-60115-1 4.19	-55°C to +155°C, 5 cycles	±(1.0%+0.10Ω)
Resistance to Solvent	JIS-C-5201-1 4.29	The tested resistor be immersed into isopropyl alcohol of 20~25°C for 60 secs. Then the resistor is left in the room for 48 hrs.	±(0.5%+0.05Ω)
Damp Heat with Load	JIS-C-5201-1 4.24 IEC-60115-1 4.24	40±2°C, 90~95% R.H. RCWV or Max. working voltage whichever is less for 1000 hrs with 1.5 hrs "ON" and 0.5 hrs "OFF" .	±(2.0%+0.05Ω)
Load Life (Endurance)	JIS-C-5201-1 4.25 IEC-60115-1 4.25.1	70±2°C, RCWV or Max. working voltage whichever is less for 1000 hrs with 1.5 hrs "ON" and 0.5 hrs "OFF" .	±(3.0%+0.10Ω)
Insulation Resistance	JIS-C-5201-1 4.6 IEC-60115-1 4.6	Apply 100VDC for 1 minute.	≥10GΩ
Bending Strength	JIS-C-5201-1 4.33 IEC-60115-1 4.33	Bending once for 5 seconds D : 0402、0603、0805=5mm 1206、1210、1812=3mm 2010、2512=2mm	±(1.0%+0.05Ω)

### ■ Recommended Customer Soldering Parameters

#### ■ Wave solder Temperature condition

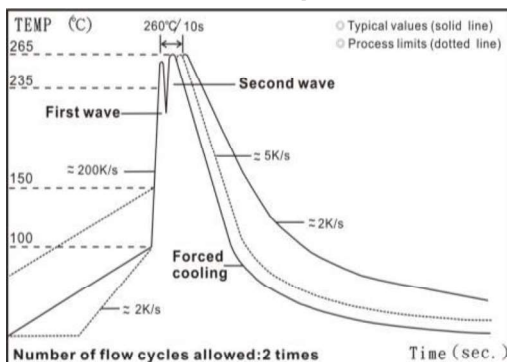





# AS Series Thick Film Anti-Surge Chip Resistor Product Specifications

Document No.	S-10-12-47-05
Released Date	2021/08/16
Page No.	9/13

## ■ Solder reflow Temperature condition

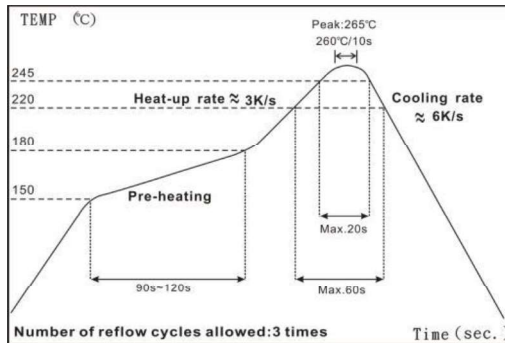

■ Rework temperature (hot air equipment) : 350°C, 3~5seconds

■ Recommended reflow methods

IR, vapor phase oven, hot air oven

If reflow temperatures exceed the recommended profile, devices may not meet the performance requirements.

## ■ Appendix For SMD Chip Resistor

### ● Packaging Information

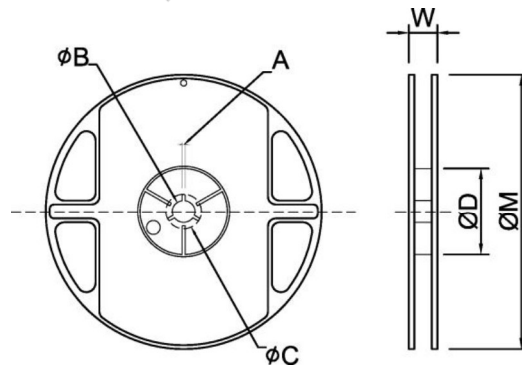

## ■ Dimension

Unit:mm

TYPE	SIZE	A	$\phi B$	$\phi C$	$\phi D$	W	$\phi M$
0402	7"	10K/Reel	2.0±0.5	13.5±1.0	21±1.0	60±1.0	178±2.0
	13"	40K/50K Reel	2.0±0.5	13.5±1.0	21±1.0	100±1.0	330±2.0
0603/0805/1206/1210	7"	5K/Reel	2.0±0.5	13.5±1.0	21±1.0	60±1.0	178±2.0
0603/0805 /1206	10"	10K/Reel	2.0±0.5	13.5±1.0	21±1.0	100±1.0	254±2.0
	13"	20K/Reel	2.0±0.5	13.5±1.0	21±1.0	100±1.0	330±2.0
2010/2512	7"	4K/Reel	2.0±0.5	13.5±1.0	21±1.0	60±1.0	178±2.0



# AS Series Thick Film Anti-Surge Chip Resistor Product Specifications

Document No.	S-10-12-47-05
Released Date	2021/08/16
Page No.	10/13

## ■ Tapping Specification

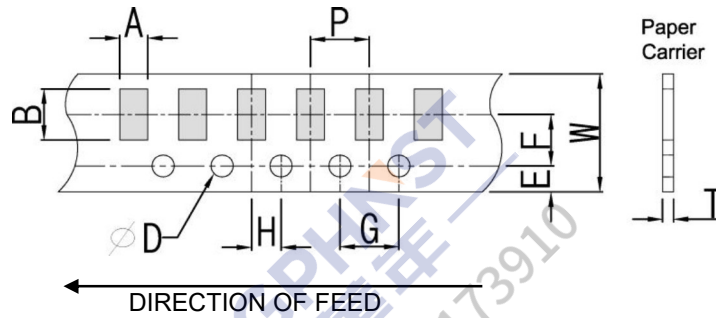

## ■ Dimension

Unit:mm

Packaging	Type	A	B	W	E	F	G	H	T	$\phi D$	P
Paper Type		0.70±0.1	1.20±0.1	8.0±0.2	1.75±0.1	3.5±0.05	4.0±0.1	2.0±0.05	0.45±0.1	1.50 <sup>+0.10</sup> <sub>-0</sub>	2.0±0.1
	0603	1.05±0.2	1.80±0.2	8.0±0.2	1.75±0.1	3.5±0.05	4.0±0.1	2.0±0.05	0.60±0.1		4.0±0.1
	0805	1.55±0.2	2.30±0.2	8.0±0.2	1.75±0.1	3.5±0.05	4.0±0.1	2.0±0.05	0.75±0.1		4.0±0.1
	1206	1.90±0.2	3.50±0.2	8.0±0.2	1.75±0.1	3.5±0.05	4.0±0.1	2.0±0.05	0.75±0.1		4.0±0.1
	1210	2.85±0.2	3.50±0.2	8.0±0.2	1.75±0.1	3.5±0.05	4.0±0.1	2.0±0.05	0.75±0.1		4.0±0.1

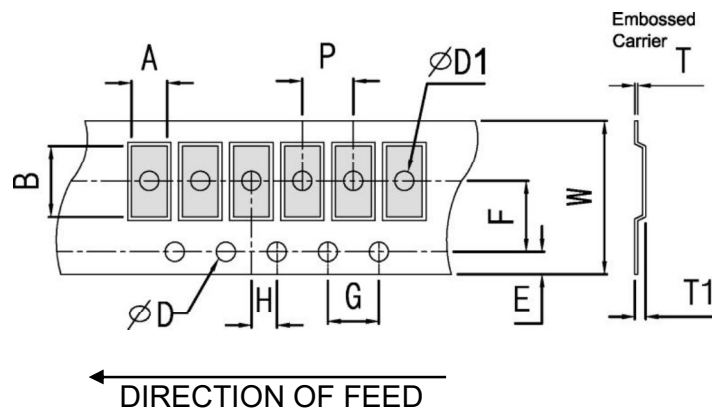

## ■ Dimension

Unit:mm

Packaging	Type	A	B	W	E	F	G	H	T	$\phi D$	$\psi D1$	T1	P
Embossed Type	2010	2.80±0.20	5.60±0.20	12±0.10	1.75±0.10	5.5±0.05	4.0±0.10	2.0±0.05	0.23±0.10	1.50 <sup>+0.10</sup> <sub>-0</sub>	1.50±0.10	0.85±0.15	4.0±0.1
	2512	3.40±0.20	6.70±0.20	12±0.10	1.75±0.10	5.5±0.05	4.0±0.10	2.0±0.05	0.23±0.10	1.50 <sup>+0.10</sup> <sub>-0</sub>	1.50±0.10	0.85±0.15	



# AS Series Thick Film Anti-Surge Chip Resistor Product Specifications

Document No.	S-10-12-47-05
Released Date	2021/08/16
Page No.	11/13

## ■ Packing Material Data/Storage Data

### ■ Front & Back Lead Dimension

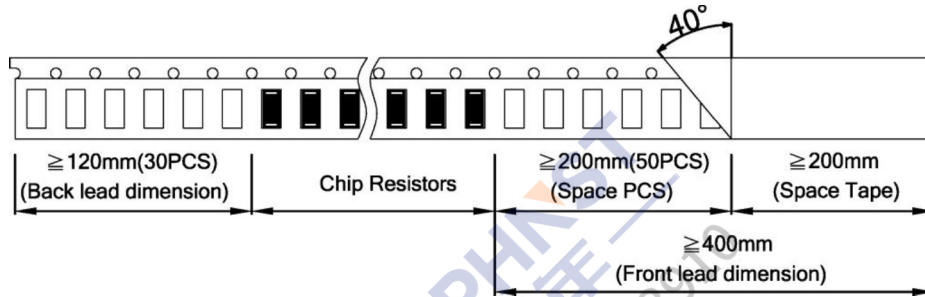

### ■ Top Adhesive Peel Off Strength : 10~70g

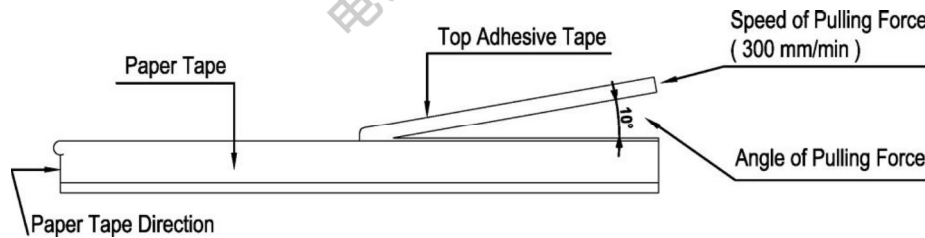

### ■ Package

Inner Box Size	
Reel	Size H(mm)
1	13
2	24
3	36
5	60
10	113

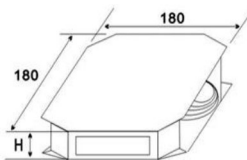

External Box Size			
Contain (Kpcs)	Length (mm)	Width (mm)	Height (mm)
25K	180	180	60
50K	180	180	110
150K	430	200	200
300K	400	400	200

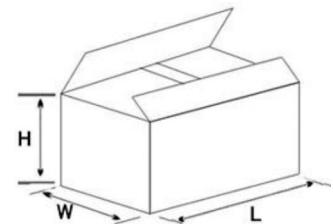

### ■ Storage Data :

Storage time at the environment temp: 25±5°C & humidity: 60±20% is valid for one year from the date of delivery.



# AS Series Thick Film Anti-Surge Chip Resistor Product Specifications

Document No.	S-10-12-47-05
Released Date	2021/08/16
Page No.	12/13

## Product Testing Method:

Our products are tested with our company's tapping & testing equipments by using four-foot probe to touch at the back of both electrodes. Supposed different testing points or methods are requested, please advise beforehand and customized-made production is available.

## 0603 E-96 Multiplier Code

Code	A	B	C	D	E	F	G	H	X	Y	Z
Multiplier	10 <sup>0</sup>	10 <sup>1</sup>	10 <sup>2</sup>	10 <sup>3</sup>	10 <sup>4</sup>	10 <sup>5</sup>	10 <sup>6</sup>	10 <sup>7</sup>	10 <sup>-1</sup>	10 <sup>-2</sup>	10 <sup>-3</sup>

CODING FORMULA

XX            X  
 ↑            ↙  
 Resistance Code    Multiplier Code

Example:  $10.2\text{K}\Omega = \underline{102} \times \underline{10^2}\Omega = 02\text{C}$   
 $33.2\Omega = \underline{332} \times \underline{10^{-1}}\Omega = 51\text{X}$

## 0603 Standard E-96 Values and 0603 Resistance Codes

R-Value	100	102	105	107	110	113	115	118	121	124	127	130	133	137	140	143	147	150	154	158	162	165	169	174
Code	01	02	03	04	05	06	07	08	09	10	11	12	13	14	15	16	17	18	19	20	21	22	23	24
R-Value	178	182	187	191	196	200	205	210	215	221	226	232	237	243	249	255	261	267	274	280	287	294	301	309
Code	25	26	27	28	29	30	31	32	33	34	35	36	37	38	39	40	41	42	43	44	45	46	47	48
R-Value	316	324	332	340	348	357	365	374	383	392	402	412	422	432	442	453	464	475	487	499	511	523	536	549
Code	49	50	51	52	53	54	55	56	57	58	59	60	61	62	63	64	65	66	67	68	69	70	71	72
R-Value	562	576	590	604	619	634	649	665	681	698	715	732	750	768	787	806	825	845	866	887	909	931	953	976
Code	73	74	75	76	77	78	79	80	81	82	83	84	85	86	87	88	89	90	91	92	93	94	95	96



## AS Series Thick Film Anti-Surge Chip Resistor Product Specifications

Document No.	S-10-12-47-05
Released Date	2021/08/16
Page No.	13/13

### ■ Standard Resistance Values in a Decade

Marking code:

- 1%: marking code, please refer to E96 and E24 data form as below  
     Ex: 120K, The marking code is 1203 in E24  
     121K, The marking code is 1213 in E96
- 5%: marking code, please refer to E24 data form as below  
     Ex: 120K, The marking code is 124 in E24
- Note: 0402 series resistor has no marking code.
- Type: 0603 1% marking code, please refer to E-96 multiplier code.
- Note: jumper zero ohm resistor marking code is one 「0」 (except type below 0402).

E96	E48	E96	E48	E96	E48	E96	E48	E96	E48						
100	100	169	169	287	287	487	487	825	825						
102		174		294		499		845							
105	105	178	178	301	301	511	511	866	866						
107		182		309		523		887							
110	110	187	187	316	316	536	536	909	909						
113		191		324		549		931							
115	115	196	196	332	332	562	562	953	953						
118		200		340		576		976							
121	121	205	205	348	348	590	590								
124		210		357		604						<b>E24</b>	<b>E12</b>	<b>E6</b>	<b>E3</b>
127	127	215	215	365	365	619	619	10	10	10	10				
130		221		374		634		11	12						
133	133	226	226	383	383	649	649	12	12						
137		232		392		665		13	15	15					
140	140	237	237	402	402	681	681	15	15	15					
143		243		412		698		16	18						
147	147	249	249	422	422	715	715	18	18						
150		255		432		732		20	22	22	22	22			
154	154	261	261	442	442	750	750	22	22	22	22				
158		267		453		768		24	27						
162	162	274	274	464	464	787	787	27	27						
165		280		475		806		30	33	33					
								33	33	33					
								36	39						
								39	39						
								43	47	47	47	47			
								47	47	47	47				
								51	56						
								56	56						
								62	68	68					
								68	68	68					
								75	82						
								82	82						
								91	91						

According to IEC publication 63